

TYPE DESEO VERSO

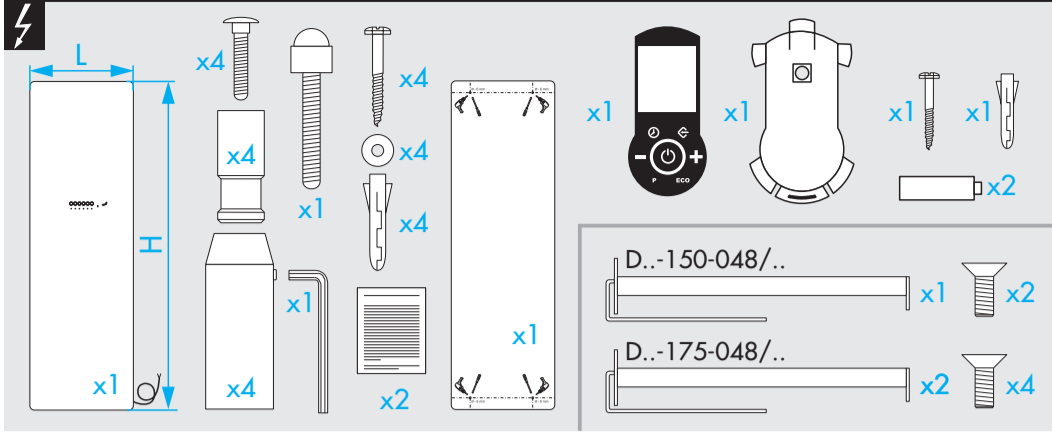

© Copyright by PBO 11/19

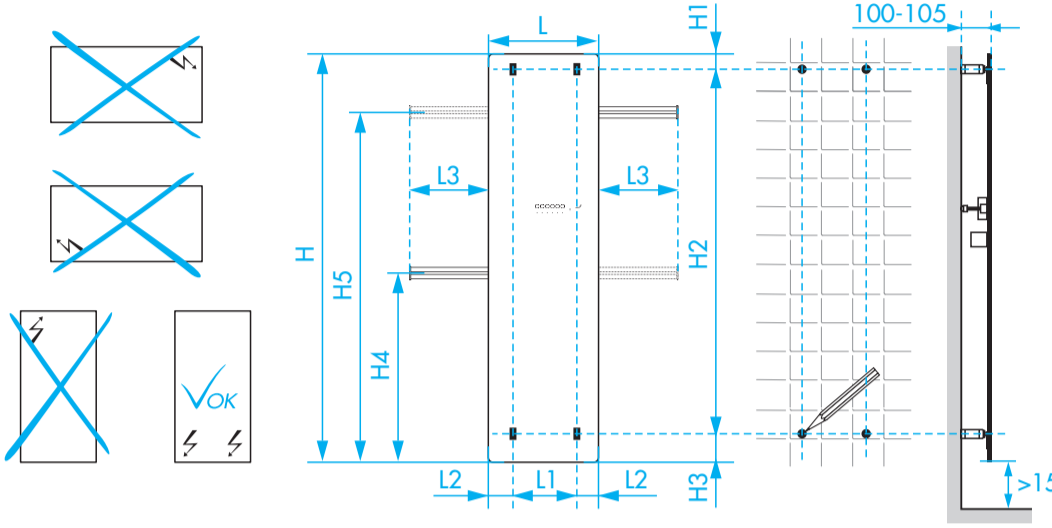
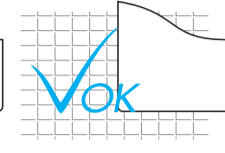
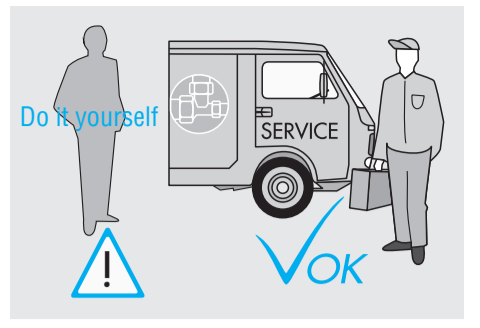
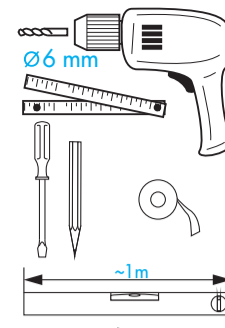
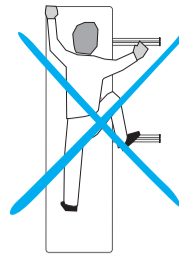

	H (mm)	H1 (mm)	H2 (mm)	H3 (mm)	H4 (mm)	H5 (mm)
D..-150-048/..	1500	55	1345	100	810	—
D..-175-048/..	1750	55	1590	105	810	1500

	L (mm)	L1 (mm)	L2 (mm)	L3 (mm)
D..-150-048/..	475	227	124	310
D..-175-048/..	475	227	124	310

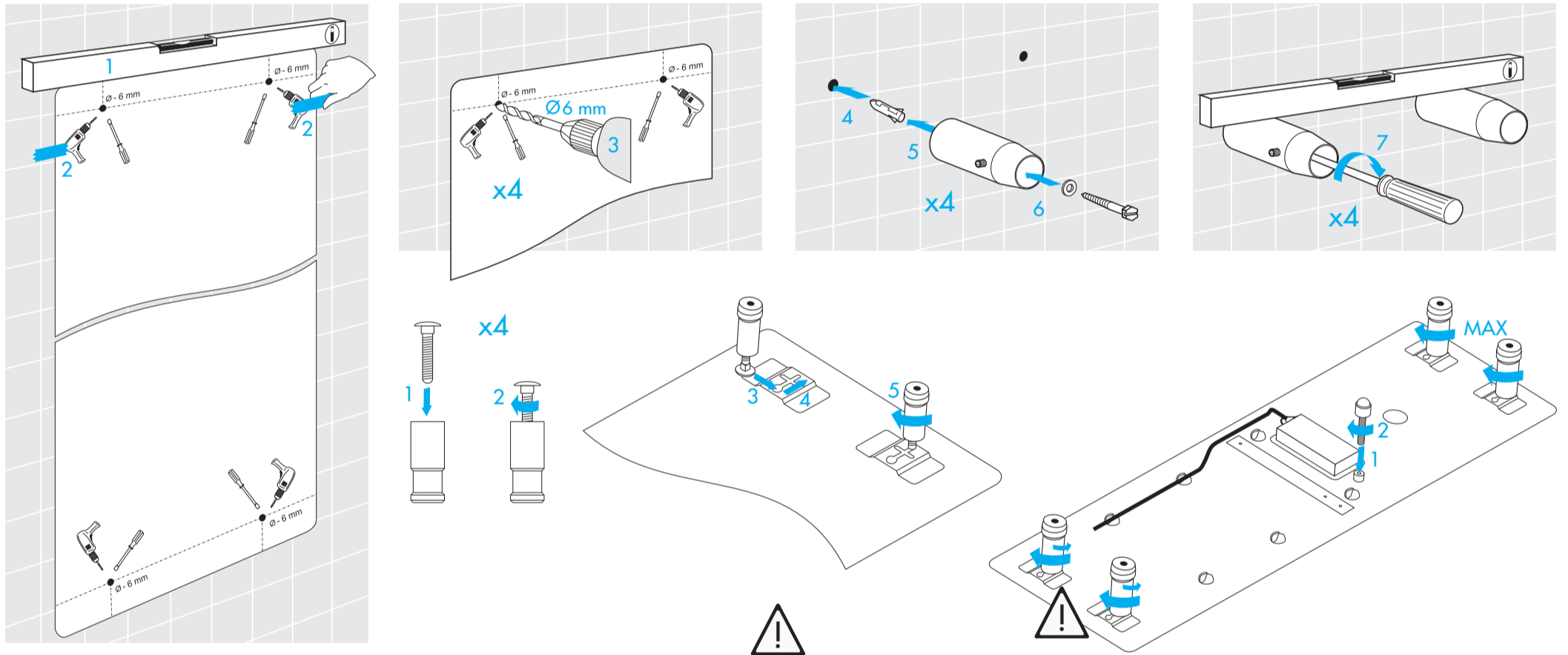

FR: IMPORTANT:

Il est conseillé de ne bloquer l'appareil qu'avec les vis des étagères supérieures. Laisser les étagères inférieures légèrement desserrées afin de permettre au panneau de se dilater pendant le réchauffement.

EN: IMPORTANT:

It is recommended to secure the appliance only with the screws on the upper shelves. Leave the lower screws slightly loosened so as to allow the expansion of the panel when heating.

DE: WICHTIG:

Es wird empfohlen, das Gerät nur mit den Schrauben der oberen Befestigungskonsolen zu blockieren. Lassen Sie die unteren Schrauben etwas locker, damit sich das Panel während des Heizens ausdehnen kann.

IT: IMPORTANTE:

Si raccomanda di bloccare l'apparecchio solo con le viti delle mensole superiori. Lasciare quelle inferiori leggermente allentate in modo da consentire al pannello di dilatarsi durante il riscaldamento.

ES: IMPORTANTE:

Se recomienda sujetar el aparato solo con los tornillos de las repisas superiores. Dejar los tornillos inferiores un poco sueltos para que el panel pueda dilatarse durante el calentamiento.

PL: WAŻNE:

Zalecane jest mocowanie urządzenia tylko wkrętami na górnych półkach. Pozostawić dolne wkręty lekko poluzowane, żeby umożliwić rozszerzanie się panelu podczas ogrzewania.

