



Comfortable indoor ventilation

Prices 2026 - Zehnder Baltics OÜ

always the best climate



always the best climate

Our mission is to provide a healthy indoor climate with top quality solutions. Living spaces are kept at a comfortable temperature by our radiators and heating & cooling ceilings whereas our ventilation solutions make sure that you can breathe fresh clean air 24/7.

zehnder

- Decorative radiators ■ Comfortable indoor ventilation
- Heating and cooling ceilings ■ Industrial air cleaning



global presence in over 70 countries

Your global partner for indoor climate



Trusted partner

We provide our customers with tailored services from planning to installation of excellent solutions for the best indoor climate since 1895.



Know what's next

Consistent focus on innovation has always been the motor for our business. We strive to provide intelligent solutions for ventilation, heating, and cooling.



Swiss quality and precision

Swiss quality and precision are reflected in all our products. Our design standards create timeless elegance in living spaces for yesterday, today, and tomorrow.



Know why, know how

It is our ongoing mission to share our expertise and know how with our customers by providing expert trainings. Our dedicated Zehnder academies bring indoor climate to life.



Here for you,
for over 125 years

125 years of Commitment

Over 125 years ago, Zehnder began with a simple dream: to create a company that offers excellent products and sustainable solutions to enhance lives. Today, this vision remains as strong as ever as we continue to address indoor climate challenges and improve quality of life. From the start, Zehnder understood the importance of being close to customers: listening, understanding and delivering value.

Our 'Here for you' philosophy guides us in growing and innovating through respectful dialogue and collaboration. Deeply rooted in European values, Zehnder is more than a company; it is a community built on trust and long-term partnerships with local presence.

We are proud to be part of this legacy, where our commitment to customer needs and local markets drives us to deliver tailored solutions. With the Zehnder family's leadership team ensuring continuity, you can rely on us for long-term support and collaboration.

Let us shape the future together.
Zehnder. Here for you!



zehnder

” *I am proud to represent the younger generation on the Board of Directors.*

Milva Inderbitzin-Zehnder



EE



LV



LT

Zehnder comfort ventilation Simple. Efficient. Smart.

Ventilation, cooling, heating and dehumidifying - your Zehnder comfort ventilation system can do it all, providing you with comfortable, healthy and energy efficient feel-good climate. The complete system offers all components from a single source. With the comprehensive product range, projects can be carried out in almost every building situation.



Air distribution system

With the well thought and proven Zehnder air distribution system, you are perfectly prepared for every structural condition.

- Round tube, flat tube or a combination of both
- Simple and time-saving mounting thanks to self explaining components and specially developed molded parts
- Insulated air distribution ComfoTherm for heating and cooling applications
- New connection system RapidLock® for quick and secure mounting



from page 47

Comfort ventilation units



- Decentralised ventilation solutions
- Central comfort ventilation units up to 600 m³/h

from page 9

General Sales and Delivery Conditions:

Our General Sales and Delivery Conditions apply.

You can find these on our website at www.zehnder.ee/muugi-ja-tarnetingimused

Filters

Zehnder original filters guarantee best performance, highest possible energy efficiency as well as a hygienic and silent operation of the ventilation unit.

- Filters extract pollen, spores and bacteria out of the fresh outdoor air - ideal for allergy sufferers.

from page 81



Controls & Sensors

- User-friendly operation - from switches to the app
- For an energy-saving and demand-based system



Connectivity

Smart control your indoor climate with our connectivity solutions:

- Voice control
- Online dashboard with system data
- Integration in BMS systems
- Remote diagnosis and maintenance



Extensions



Cooling, heating and dehumidifying: System extensions for Zehnder ventilation units enhance comfort and energy efficiency.

- **Cooling unit** – Air-to-air heat pump with inverter technology for air pre-treatment.
- **Enthalpy exchanger** – regulation of humidity

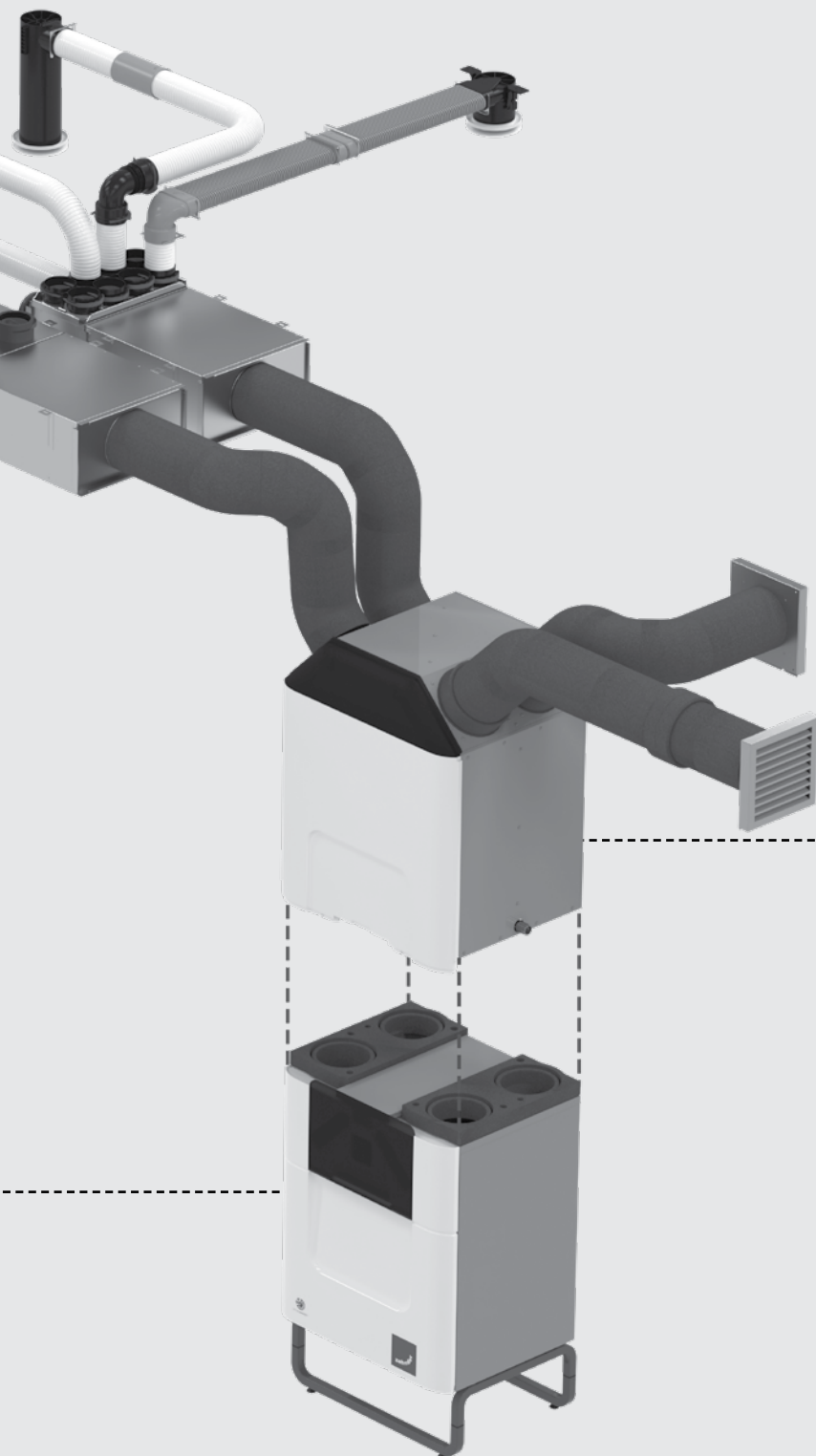



Zehnder comfort ventilation units**Page 12**

Decentralised ventilation solutions
Central comfort ventilation units up to 600 m³/h
System expansions

Zehnder air distribution system**Page 47**

Connection accessories for ventilation units
Silencer/manifold system
Ventilation tubes and moulded parts
Air outlets

Zehnder outdoor and exhaust air**Page 77**

Facade system
Outdoor air/exhaust air connector

Zehnder replacement filters**Page 81**

Replacement filters for ventilation units
and air distribution systems

General Sales and Delivery Conditions:

Our General Sales and Delivery Conditions apply.

You can find these on our website at www.zehnder.ee/muugi-ja-tarnetingimused



Zehnder comfort ventilation units

10 – 44

Information on filter standards	10
Information & overview of energy efficiency classes	12
Overview of comfort ventilation units	18
Extract Fans	22
ComfoSpot 50 decentralised comfort ventilation unit	23
ComfoAir 70 decentralised comfort ventilation unit	25
ComfoAir 180 comfort ventilation unit	27
ComfoAir 200 comfort ventilation unit	28
Climos 200 Eco comfort ventilation unit	29
Climos 200 comfort ventilation unit	30
EVO 2 comfort ventilation unit	31
EVO 3 comfort ventilation unit	31
EVO 4 comfort ventilation unit	31
ComfoAir Standard 375 comfort ventilation unit	33
ComfoAir Flex 250 / 350 comfort ventilation unit	35
ComfoAir E350 comfort ventilation unit	37
ComfoAir Q350 TR comfort ventilation unit	38
ComfoAir Q450 TR comfort ventilation unit	38
ComfoAir Q600 ST comfort ventilation unit	39
ComfoClima 24 / 36	41
ComfoFond-L Q brine-earth heat exchangers	42
Enthalpy exchanger	44
Defroster heater, demand control	44

Be sure with Zehnder original filters to the new ISO 16890 air filter standard

Zehnder ventilation units provide rooms with a permanent supply of fresh and healthy air. The original filter in your ventilation system plays an important role here. In order to better evaluate filter performance, the standard that tests filter performance has now been adapted.

The ISO 16890 air filter standard has superseded the previous standard, EN 779, with regard to filter assessment and classification since January 2017 and came into force in its entirety as of 1 July 2018.

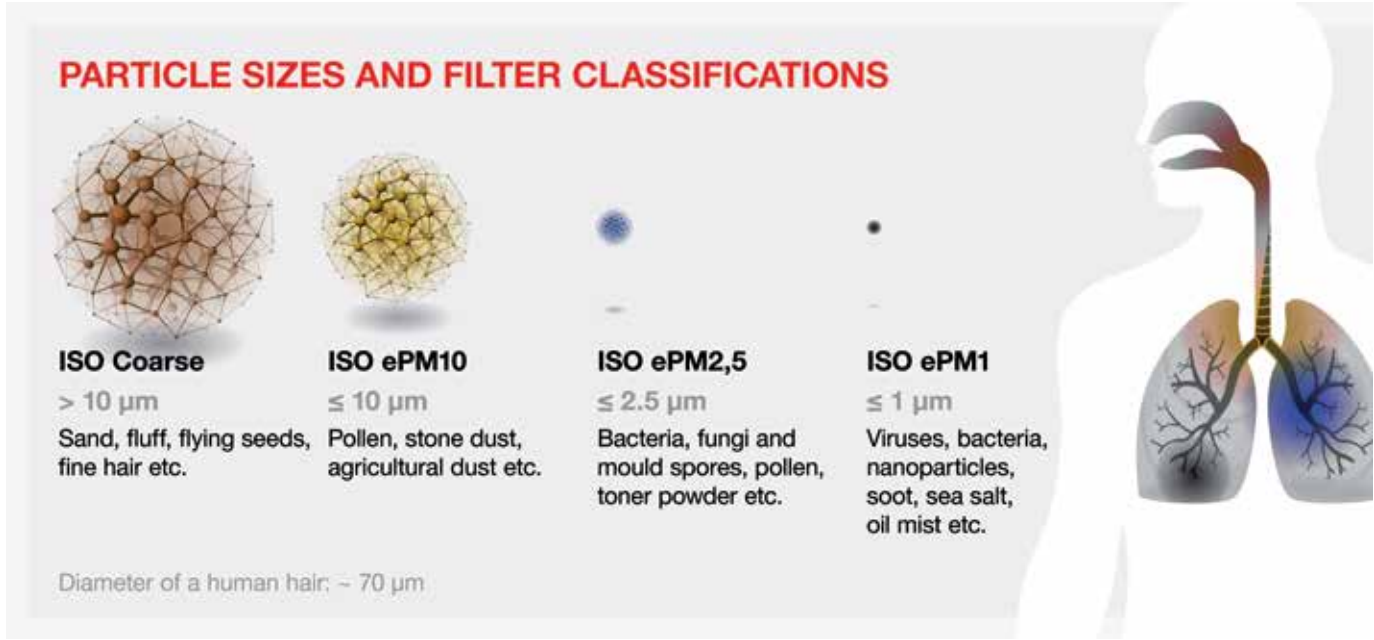

Particle sizes and filter classification according to the new ISO 16890 air filter standard

ISO 16890 at a glance

Realistic assessment of filters

- ISO 16890 replaces the EN779 standard, whereby only a single particle size of 0.4 µm was used to assess filter performance
- Fine dust, such as soot or pollen, however, comes in different sizes, which are often invisible to the naked eye
- ISO 16890 now divides filters into four classes that filter a certain particle span out of the air
- To be assigned a category, a filter must separate at least 50% of the respective particle sizes.

New name – same high performance

With Zehnder, you can make the perfect choice for an ideal indoor climate every time. High performance is a given when it comes to the development of our original filters. Due to the perfect coordination of the ventilation system and the original filter, the required standards had already been met even before the introduction of the new ISO 16890 air filter standard. So essentially only the name of our filters has changed – but the performance is still the same.

- With the ideal combination of ventilation system and original Zehnder filters, you can be assured.
- This means that our filter set for Zehnder ComfoAir Q, for example, is no longer called F7, but instead ISO ePM1 greater than or equal to 50%.

The energy efficiency label

The energy efficiency marking for comfort ventilation units that was introduced in January 2016 offers you and your customers more information and transparency as well as better guidance with regard to quality and efficiency. For Zehnder, the label signifies a confirmation of the high standards of energy efficiency for products and systems. It also benefits end users going forward, as they continue to choose ventilation units which combine the very best results with maximum functionality.

What is the significance of the energy efficiency label?

At a glance:

- Alphabetic classification in energy efficiency classes from A+ to G
- Parameter for specific energy consumption (SEC): annual power consumption minus annual energy saving
- Most Zehnder units for central comfort ventilation have been classified as A+. Airflow volume, heat and humidity recovery, fans and the control unit all affect the energy efficiency class.









The energy efficiency label

SEC class	SEC in kWh/m ² ·a
A+ (highest efficiency)	SEC < - 42
A	-42 ≤ SEC < -34
B	-34 ≤ SEC < -26
C	-26 ≤ SEC < -23
D	-23 ≤ SEC < -20
E	-20 ≤ SEC < -10
F	-10 ≤ SEC < 0
G (lowest efficiency)	0 ≤ SEC

A SEC of 0 is equivalent to window ventilation. A SEC of -42 indicates primary energy savings of 42 kWh/m² a.

Overview of energy efficiency classes¹⁾





















Decentralised ventilation unit	Page	Article number	Control according to site requirements			Manual control
			Humidity sensor board 527 007 260	Humidity and VOC sensor board 527 007 270	Humidity and CO ₂ sensor board 527 007 280	
 ComfoSpot 50	23	527 007 210 527 007 220 527 008 580 527 008 770				 ²⁾
 ComfoAir 70	25	527 007 240 527 007 250 527 008 590 527 008 780				

¹⁾ Energy efficiency classes in accordance with Directive 2009/125/EC of EU Regulation no. 1253/2014

²⁾ The control is integrated in the unit













³⁾ Energy efficiency class applies in conjunction with one or two adjoining room connections. If there is no adjoining room connection, energy efficiency class B applies

Overview of energy efficiency classes¹⁾







Comfort ventilation unit	Page	Article number	Control according to site requirements		Central demand control	Time control
			2 x CO ₂ sensors 655 000 850 / 655 000 855	CO ₂ sensor 655 000 850 / 655 000 855		
 ComfoAir 180	27	471 212 215	-	-	-	
 ComfoAir 180 enthalpy	27	471 212 235	-	-	-	
 ComfoAir 200	28	471 222 110 471 222 115				
 ComfoAir 200 enthalpy	28	471 222 470 471 222 475				
 ComfoAir Standard 375	33	471 239 610 471 239 611				
 ComfoAir Standard 375 enthalpy	33	471 239 618 471 239 619				

¹⁾ Energy efficiency classes in accordance with Directive 2009/125/EC of EU Regulation no. 1253/2014

Overview of energy efficiency classes¹⁾







Comfort ventilation unit	Page	Article number	Multi-speed control
 EVO 2	31	471 100 085	
		471 100 078	
 EVO 2 enthalpy	31	471 100 086	
		471 100 079	
 EVO 3	31	471 100 087	
		471 100 083	
 EVO 3 enthalpy	31	471 100 088	
		471 100 084	
 EVO 4	31	471 100 089	
		471 100 080	
 EVO 4 enthalpy	31	471 100 090	
		471 100 081	

¹⁾ Energy efficiency classes in accordance with EU Regulation no. 1254/2014; depending on the control unit/type of sensors chosen.

Overview of energy efficiency classes ¹⁾					
Comfort ventilation unit	Page	Article number	Control according to site requirements	Time control	Manual control
			1 x CO ₂ sensor 655 000 850 / 655 000 855	TFT RD 521 014 140	LED RD 521 014 130
 Climos 200 Eco enthalpy	29	527 006 320 527 006 330		-	-
 Climos 200 enthalpy	30	527 003 270 527 003 260			

¹⁾ Energy efficiency classes in accordance with Directive 2009/125/EC of EU Regulation no. 1253/2014

Overview of energy efficiency classes¹⁾

Comfort ventilation unit		Page	Article number	Control according to site requirements Option box ²⁾ 471 502 000	Central demand control	Time control	Manual control
				2 x CO ₂ sensors 655 000 850 / 655 000 855 + 1 x CO ₂ sensor 655 000 850 / 655 000 855	No further accessories	No further accessories	No further accessories
	ComfoAir Flex 250	35	471 234 190	A ⁺	A	A	A
	ComfoAir Flex 250 enthalpy	35	471 234 410	A ⁺	A	A	A
	ComfoAir Flex 350	35	471 234 205	A ⁺	A	A	A
	ComfoAir Flex 350 enthalpy	35	471 234 415	A ⁺	A	A	A
	ComfoAir E350 ³⁾	37	471 508 125 471 508 130	A ⁺	A ⁺	-	A
	ComfoAir E350 enthalpy ³⁾	37	471 508 230 471 508 225	A ⁺	A	-	A
	ComfoAir Q350 TR	38	471 502 110	A ⁺	A ⁺	A	A
	ComfoAir Q350 TR enthalpy	38	471 502 111	A ⁺	A	A	A
	ComfoAir Q450 TR	38	471 502 112	A ⁺	A ⁺	A	A
	ComfoAir Q450 TR enthalpy	38	471 502 113	A ⁺	A	A	A
	ComfoAir Q600 ST	39	471 502 114	A ⁺	A	A	A
	ComfoAir Q600 ST enthalpy	39	471 502 115	A	A	B	B

¹⁾ Energy efficiency classes in accordance with Directive 2009/125/EC of EU Regulation no. 1253/2014

²⁾ Option Box is not combineable with ComfoAir Flex and ComfoAir E350 units.



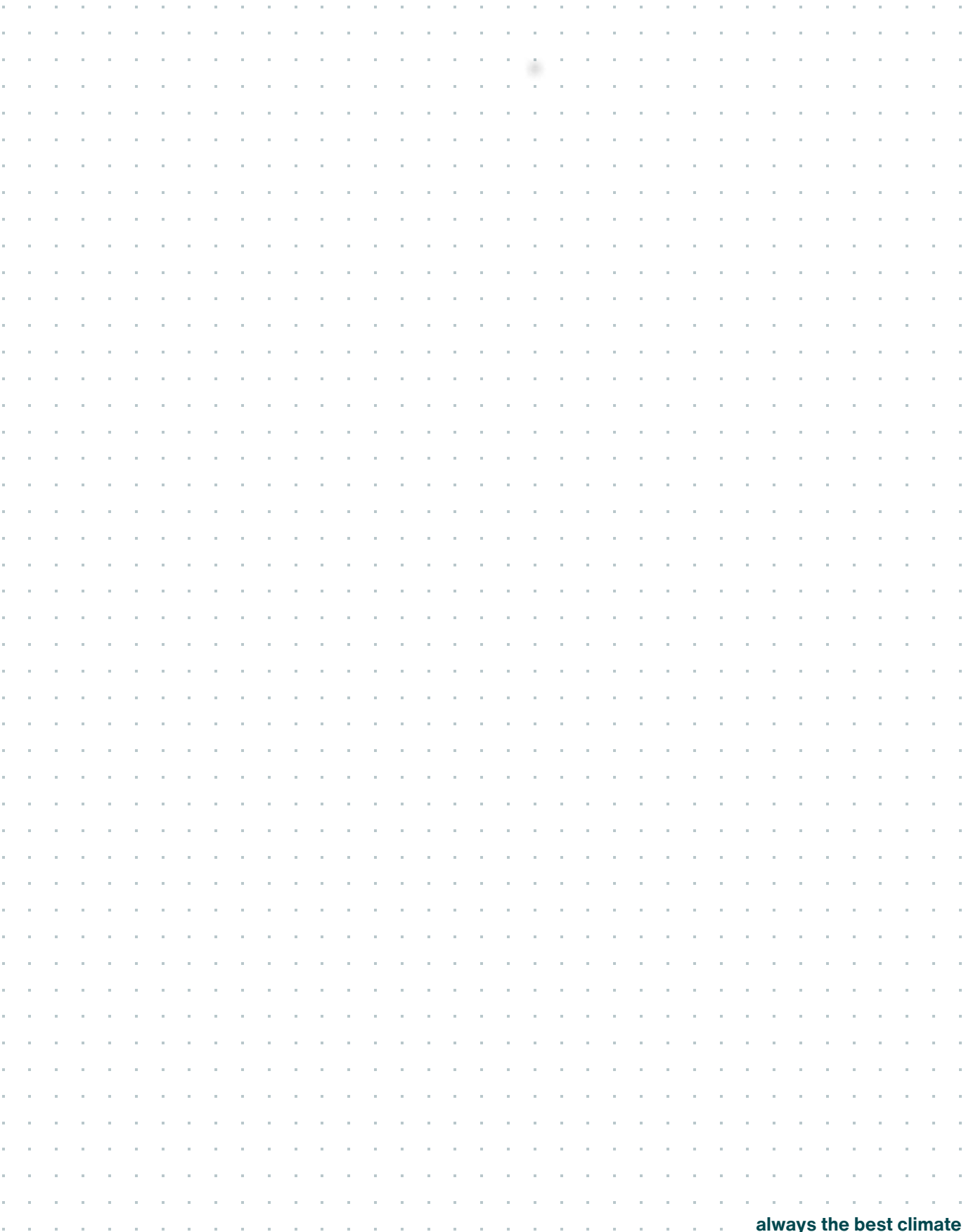

³⁾ Possible to connect one sensor.

Notes



always the best climate

Overview of decentralised comfort ventilation units























	Model	Page	Air volume															
			50 (m³/h)	100 (m³/h)	150 (m³/h)	200 (m³/h)	250 (m³/h)	300 (m³/h)	350 (m³/h)	400 (m³/h)	450 (m³/h)	500 (m³/h)	550 (m³/h)					
Decentralised	ComfoSpot 50  	23	15 - 50															
	ComfoAir 70   	25	15 - 60															

■ Maximum air volume range

Dimensions / weight				Installation			Nominal connection size	Unit version	
Length (mm)	Height (mm)	Depth (mm)	Weight from (kg)	Wall	Ceiling	Floor-mounted with base	DN / mm	Supply air, left	Supply air, right
380 ¹⁾	376 ¹⁾	50 ¹⁾	6	•					
440 ¹⁾	660 ¹⁾	145 ¹⁾	22	•			90 mm		

¹⁾ Dimensions of interior wall panel

Overview of centralised comfort ventilation units



	Model	Page	Air volume																				
			50 (m³/h)	100 (m³/h)	150 (m³/h)	200 (m³/h)	250 (m³/h)	300 (m³/h)	350 (m³/h)	400 (m³/h)	450 (m³/h)	500 (m³/h)	550 (m³/h)										
Centralised	ComfoAir 180   	27	30 – 180																				
	ComfoAir 200 	28	50 – 200																				
	Climos 200, Climos 200 Eco   	29	50 – 200																				
	EVO 2 	31	45 – 200																				
	EVO 3 	31	45 – 300																				
	EVO 4 	31	45 – 400																				
	ComfoAir Standard 375 	33	40 – 375																				
	ComfoAir Flex 250 	35	40 – 250																				
	ComfoAir Flex 350 	35	40 – 350																				
	ComfoAir E350 	37	40 – 350																				
	ComfoAir Q350 TR   	38	40 – 350																				
	ComfoAir Q450 TR   	38	50 – 450																				
	ComfoAir Q600 ST   	39	60 – 600																				









■ Maximum air volume range

Dimensions / weight				Installation			Nominal connection size	Unit version	
Length (mm)	Height (mm)	Depth (mm)	Weight from (kg)	Wall	Ceiling	Floor-mounted with base	DN / mm	Supply air, left	Supply air, right
558	680	299	22	•			DN 125		
544	1200	324	30	•	•		DN 125		
594	1019	250	25	•	•		DN 125		
1000	210	600	24	•	•		DN 160		
1160	269	600	36	•	•		DN 160		
1160	269	600	39	•	•		DN 160		
702	845	572	42	•		•	DN 160		
960	1110	350	45		•		DN 160		
960	1110	350	45		•		DN 160		
725	870	560	50	•		•	DN 160		
775	850	570	50	•		•	DN 160		
775	850	570	50	•		•	DN 160		
725	850	570	50	•		•	DN 180		

²⁾ Turn the unit to change it to the left-hand or right-hand version







ODA = outdoor air, ETA = extract air, EHA = exhaust air, SUP = supply air

Extract Fans						
Product	Description	PU 1	PU 2	Article no.	Gross price €	Discount group
Zehnder Unity ZCV2						
	Continuously running bathroom and kitchen fan 100 mm mixed flow extract fan with SMART HT which can be applied to all wet rooms including kitchen, bathroom, utility and WCs. With ultra-low energy DC motor, CE marked, CommissionSMART, TimerSMART, IPX5 for walls, IPX4 for ceilings	8	144	ZCV2	259,40	77
Zehnder Unity ZCV3						
 	Low energy continuously running bathroom and kitchen fan 100 mm mixed flow low energy fan, one solution for bathroom, kitchens, utility rooms and WCs. Connect SMART contactless technology for simple set up, customisation and data logging, CE marked, do not disturb technology, SMART Humidity sensing, SMART overrun timer, IPX5 for walls, IPX4 for ceilings	-	-	ZCV3si	296,30	77

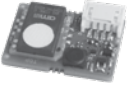
ComfoSpot decentralised ventilation unit						
Product	Description	PU 1	PU 2	Article no.	Gross price €	Discount group
ComfoSpot 50						
  Passive house certified	ComfoSpot 50 comfort ventilation unit 50 m³/h airflow volume, cross-counterflow enthalpy exchanger with humidity recovery, for installation in outside wall, with built-in control panel, without wall mounting tube. A wall mounting tube is required for wall installation. As an option, sensor boards for measuring humidity, VOC and CO₂ and/or an external control panel can be installed (accessories) Dimensions: Inside wall panel: 380 x 376 x 50 mm (W x H x D) Outside wall panel: 380 x 376 x 50 mm (W x H x D)					
	ComfoSpot 50 comfort ventilation unit Plastic outside wall panel , without wall mounting tube <i>CSP50-PRM-FRT-PLS</i>	-	9	527 007 210	1.129,40	K3
	ComfoSpot 50 comfort ventilation unit Stainless steel outside wall panel , without wall mounting tube <i>CSP50-PRM-FRT-SST</i>	-	9	527 007 220	1.319,00	K3
	ComfoSpot 50 comfort ventilation unit 50m³/h airflow volume, cross-counterflow enthalpy heat exchanger with humidity recovery, for installation in the outside wall, with built-in humidity sensor board , control panel and plastic outside wall panel, without wall mounting tube. For wall mounting a wall mounting tube is necessary. Optionally an external control panel can be installed (accessory part). <i>CSP50-PRM-RH-FRT-PLS</i>	-	9	527 008 770	1.282,80	K3
	ComfoSpot 50 comfort ventilation unit 50m³/h airflow volume, cross-counterflow enthalpy heat exchanger with humidity recovery, for installation with window reveal module , with built-in control panel and plastic inside wall panel, without outside wall panel. Optionally sensor boards for humidity, VOC-, CO₂ - measuring and/or an external control panel can be installed (accessory parts) <i>CSP50-PRM</i>	-	9	527 008 580	1.088,00	K3
	Window reveal module for ComfoSpot 50 consisting of switching unit with solid-state round wall mounting pipe (length= 580 mm) and plugs, 2 flat ducts each à 2040 x 300 mm with seals, 2 flat ducts insulation elements, duct adapter and external wall grille <i>CON-RVL-CSP50</i>	-	4	527 008 660	525,50	C
ComfoSpot 50 accessories						
	ComfoLED control panel for ComfoSpot 50 and ComfoAir 70 Interface made from acrylic glass, with frame (cut-out 55 x 55 mm) <i>WR-CSP50-CA70-FRA-PCK</i>	-	-	528 009 050	108,90	C
	ComfoRF module for ComfoSpot 50 and ComfoAir 70 Radio frequency module for decentral app-controlling <i>KIT-RF-MOD</i>	-	-	527 010 550	145,10	C

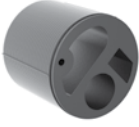
* Energy efficiency class applies in conjunction with one sensor; see overview of energy efficiency classes.

ComfoSpot decentralised ventilation unit

Product	Description	PU 1	PU 2	Article no.	Gross price €	Discount group
ComfoSpot 50 accessories						
	Humidity sensor board for ComfoSpot 50 and ComfoAir 70 Sensor board for connection in the unit <i>KIT-SNS-MOD-RH-PCK</i>	-	-	527 007 260	85,70	C
	Humidity and VOC sensor board for ComfoSpot 50 and ComfoAir 70 Sensor board for connection in the unit <i>KIT-SNS-MOD-VOC-PCK</i>	-	-	527 007 270	225,00	C
	Round wall mounting tube made from plastic, Ø 315 mm, with 2 blanking plugs, for retrofitting length = 600 mm <i>MAC-CSP50-PIP-DN315-L600-PLS</i> length = 900 mm <i>MAC-CSP50-PIP-DN315-L900-PLS</i>	-	16	990 800 453	113,00	C
	Square wall mounting tube made from EPP, 360 x 360 (W x H), length = 600 mm, with 2 blanking plugs, for new builds <i>MAC-CSP50-DCT-W360-H360-D600-EPP</i>	-	16	527 005 450	231,20	C
	Extension set for ComfoSpot 50 made of EPP, with 2 plugs, outside diameter 315 mm, length = 285 mm. For wall thickness greater than 600 mm, in combination with round wall mounting tube length = 900 mm <i>SET-EXT-CSP50</i>	-	24	527 009 150	147,90	C
	Filter set for ComfoSpot 50, ISO Coarse (G4) 2 pieces <i>FIL-CSP50-CRS/G4-2PC-PCK</i>	28	560	527 005 390	31,40	K5
	Filter set for ComfoSpot 50, ISO Coarse / ISO ePM10 (G4 / F7) 2 pieces <i>FIL-CSP50-CRS/G4-ePM10/F7-2PC-PCK</i>	-	-	527 005 400	34,20	K5
	Filter set for ComfoSpot 50, ISO Coarse (G4) 10 pieces <i>FIL-CSP50-CRS/G4-10PC-PCK</i>	-	-	527 005 410	118,50	K5
	Filter set for ComfoSpot 50, ISO Coarse / ISO ePM10 (G4 / F7) 10 pieces <i>FIL-CSP50-CRS/G4-ePM10/F7-10PC</i>	-	-	527 005 420	130,00	K5

ComfoAir decentralised ventilation unit

Product	Description	PU 1	PU 2	Article no.	Gross price €	Discount group
---------	-------------	------	------	-------------	---------------	----------------



ComfoAir 70

	<p>ComfoAir 70 comfort ventilation unit 60 m³/h (50 Pa) airflow volume, cross-counterflow enthalpy exchanger with humidity recovery, for installation on the inside of outside walls, with connections for ventilation ducts to supply and extract from adjoining rooms, with built-in control panel, without wall mounting tube. Supply connector on rear or side (right) DN 100, Extract air connector on rear or side (left) DN 100 As an option, sensor boards for measuring humidity, VOC and CO₂ and/or an external control panel can be installed (accessories) Dimensions: Inside wall panel: 440 x 660 x 145 mm (W x H x D) Outside wall panel: 380 x 376 x 50 mm (W x H x D)</p>					
	<p>ComfoAir 70 comfort ventilation unit Plastic outside wall panel, without wall mounting tube <i>CA70-PRM-FRT-PLS</i></p>	-	4	527 007 240	1.585,20	K3
	<p>ComfoAir 70 comfort ventilation unit Stainless steel outside wall panel, without wall mounting tube <i>CA70-PRM-FRT-SST</i></p>	-	4	527 007 250	1.773,60	K3

	<p>ComfoAir 70 comfort ventilation unit 60m³/h (50 Pa) airflow volume, cross-counterflow enthalpy heat exchanger with humidity recovery, for installation in the inside of the outside wall, with connections for ventilation ducts to supply and extract adjoining rooms with built-in humidity sensor board, control panel and plastic outside wall panel, without wall mounting tube. Supply connector on rear or side (right) DN 100, Extract Air connector on rear or side (left) DN 100. Optionally an external control panel can be installed (accessory part). <i>CA70-PRM-RH-FRT-PLS</i></p>	-	4	527 008 780	1.703,20	K3
-------------------------------------------------------------------------------------	------------------------------------------------------------------------------------------------------------------------------------------------------------------------------------------------------------------------------------------------------------------------------------------------------------------------------------------------------------------------------------------------------------------------------------------------------------------------------------------------------------------------------------------------------------------------------------------------------------------------------------------------------------------------------------	---	---	-------------	----------	----









	<p>ComfoAir 70 comfort ventilation unit 60m³/h (50 Pa) airflow volume, cross-counterflow enthalpy heat exchanger with humidity recovery, for installation with window reveal module, with connections for ventilation ducts to supply and extract adjoining rooms, with built-in control panel and plastic inside wall panel, without outside wall panel and wall mounting tube. Optionally sensor boards for humidity, VOC-, CO₂ - measuring and/or an external control panel can be installed (accessory parts) <i>CA70-PRM</i></p>	-	4	527 008 590	1.536,90	K3
	<p>Window reveal module for ComfoAir 70 consisting of switching unit with solid-state round wall mounting tube (length = 580 mm) and plugs, 2 flat ducts each à 2040 x 300 mm with seals, 4 flat ducts insulation elements, 2 duct adapters and 2 external wall grilles <i>CON-RVL-CA70</i></p>	-	4	527 008 670	525,50	C

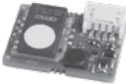



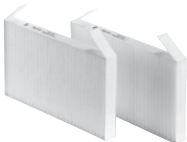







ComfoAir 70 accessories

	<p>ComfoLED control panel for ComfoSpot 50 and ComfoAir 70 Interface made from acrylic glass, with frame (cut-out 55 x 55 mm) <i>WR-CSP50-CA70-FRA-PCK</i></p>	-	-	528 009 050	108,90	C
	<p>ComfoRF module for ComfoSpot 50 and ComfoAir 70 Radio frequency module for decentral app-controlling <i>KIT-RF-MOD</i></p>	-	-	527 010 550	145,10	C





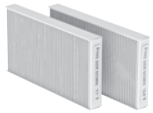
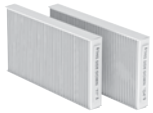





* Energy efficiency class applies in conjunction with one sensor; see overview of energy efficiency classes.

ComfoAir decentralised ventilation unit

Product	Description	PU 1	PU 2	Article no.	Gross price €	Discount group
ComfoAir 70 accessories						
	Humidity sensor board for ComfoSpot 50 and ComfoAir 70 Sensor board for connection in the unit <i>KIT-SNS-MOD-RH-PCK</i>	-	-	527 007 260	85,70	C
	Humidity and VOC sensor board for ComfoSpot 50 and ComfoAir 70 Sensor board for connection in the unit <i>KIT-SNS-MOD-VOC-PCK</i>	-	-	527 007 270	225,00	C
	Round wall mounting tube made from plastic, Ø 250 mm, with 2 blanking plugs, for retrofitting length = 600 mm <i>MAC-CA70-PIP-DN250-D600-PLS</i>	-	30	990 800 452	98,80	C
	length = 900 mm <i>MAC-CA70-PIP-DN250-L900-PLS</i> Square wall mounting tube made from EPP, 268 x 268 (W x H), length = 600 mm, with 2 blanking plugs, for new builds <i>MAC-CA70-DCT-W268-H268-D600-EPP</i>	-	15	990 800 451	121,00	C
	Extension set for ComfoAir 70 made of EPP, with 2 plugs, outside diameter 250 mm, length = 285 mm. For wall thickness greater than 600 mm, in combination with round wall mounting tube length = 900 mm <i>SET-EXT-CA70</i>	-	40	527 009 140	190,30	C
	Filter set for ComfoAir 70, ISO Coarse (G4) 2 pieces <i>FIL-CA70-CRS/G4-2PC-PCK</i>	28	448	527 005 180	34,30	K5
	Filter set for ComfoAir 70, ISO Coarse / ISO ePM10 (G4 / F7) 2 pieces <i>FIL-CA70-CRS/G4-ePM10/F7-2PC-PCK</i>	28	560	527 005 190	38,00	K5
	Filter set for ComfoAir 70, ISO Coarse (G4) 10 pieces <i>FIL-CA70-CRS/G4-10PC</i>	14	280	527 005 160	128,40	K5
	Filter set for ComfoAir 70, ISO Coarse / ISO ePM10 (G4 / F7) 10 pieces <i>FIL-CA70-CRS/G4-ePM10/F7-10PC</i>	-	-	527 005 170	138,10	K5
	Sealing tape for ComfoAir 70 1 piece for twin-room connection <i>SEL-PRF-SAD-W9.5-L1000-0049-PCK</i>	-	-	521 000 580	7,90	B







ComfoAir ventilation units						
Product	Description	PU 1	PU 2	Article no.	Gross price €	Discount group
ComfoAir 180						
	ComfoAir 180 V comfort ventilation unit 180 m³/h (170 Pa) airflow volume, cross-counterflow heat exchanger with automatic summer bypass 100%, for wall installation, including wall plate, four connectors upwards or supply connector downwards, without control panel, with pre-heater . Dimensions: 558 x 680 x 299 mm (W x H x D) <i>CA180-PRH-ND-DE-MCF</i>	-	6	 471 212 215	2.930,60	C
	ComfoAir 180 V enthalpy comfort ventilation unit 180 m³/h (170 Pa) airflow volume, cross-counterflow enthalpy exchanger with humidity recovery and automatic summer bypass 100%, for wall installation, including wall plate, four connectors upwards or supply connector downwards, without control panel, with pre-heater . Dimensions: 558 x 680 x 299 mm (W x H x D) <i>CA180-ERV-PRH-ND-DE-MCF</i>	-	5	 471 212 235	4.248,90	C
 Passive house certified						
ComfoAir 180 accessories						
	Multi Control white for ComfoAir 180 Touch screen for adjusting the ventilation flow rate, with display of unit parameters. The integrated Wi-Fi allows Multi Control to be displayed and controlled via the Zehnder Multi Controller App. <i>Zehnder Multi Control White 502</i>	-	-	399 000 216	367,00	C
	Multi Control black for ComfoAir 180 Touch screen for adjusting the ventilation flow rate, with display of unit parameters. The integrated Wi-Fi allows Multi Control to be displayed and controlled via the Zehnder Multi Controller App. <i>Zehnder Multi Control Black</i>	-	-	399 000 201	367,00	C
	ComfoSense 67 control panel for ComfoAir 160, 180, 200, 375 and 550 Including cover frame, cover and surface-mounted housing in RAL 9016 <i>CU-CFS67-HSG-9016</i>	30	30	655 010 215	329,10	C
	Remote-controlled control panel as an additional handset for the Sense control panel <i>CU-RF-Z1</i>	150	-	655 000 755	140,80	C
	Dry siphon 5/4" for ComfoAir 180 <i>SIP-5/4"-CA350/550-CF-L</i>	20	400	990 201 330	64,00	C
	Dry siphon set for ComfoAir 160, 180, 200 made from white HDPE plastic, variable wastewater connection, closed on suction side <i>SIP-CA160/180/200</i>	20	320	990 201 331	108,00	C
	Filter set for ComfoAir 180, ISO Coarse (G4) 2 pieces <i>FIL-CA180-SET-CRS/CRS</i>	160	350	400 100 090	44,50	K5
	Filter set for ComfoAir 180, ISO Coarse / ISO ePM1 (G4 / F7) 2 pieces <i>FIL-SET-CA180-SET-CRS/EPM1</i>	100	300	400 100 091	47,30	K5
	ComfoPipe Plus connection box DN 125 for vertical connection of ComfoAir 180 to ComfoPipe 125, material EPP, with unit connection element	72	72	990 328 804	77,50	C

* Energy efficiency class applies in conjunction with a time control; see overview of energy efficiency classes.







ComfoAir ventilation units						
Product	Description	PU 1	PU 2	Article no.	Gross price €	Discount group
ComfoAir 200						
  Passive house certified	ComfoAir 200 V Luxe comfort ventilation unit 200 m³/h (200 Pa) airflow volume, cross-counterflow heat exchanger with automatic summer bypass 100%, with pre-heater , for wall and ceiling mounting, without control panel. Dimensions: 544 x 1200 x 324 mm (W x H x D)					
	ComfoAir 200 VL Luxe with left supply connector <i>CA200-L-LX-PRH-ND-DE-MCF</i>	-	3	471 222 110	3.608,90	C
	ComfoAir 200 VR Luxe with right supply connector <i>CA200-R-LX-PRH-ND-DE-MCF</i>	-	3	471 222 115	3.608,90	C
	ComfoAir 200 V Luxe enthalpy comfort ventilation unit 200 m³/h (200 Pa) airflow volume, cross-counterflow enthalpy exchanger , with humidity recovery and automatic summer bypass 100%, with pre-heater , for wall and ceiling mounting, without control panel. Dimensions: 544 x 1200 x 324 mm (W x H x D)					
	ComfoAir 200 VL Luxe enthalpy with left supply connector <i>CA200-L-LX-ERV-PRH-ND-DE-MCF</i>	-	3	471 222 470	5.073,60	C
	ComfoAir 200 VR Luxe enthalpy with right supply connector <i>CA200-R-LX-ERV-PRH-ND-DE-MCF</i>	-	3	471 222 475	5.073,60	C
ComfoAir 200 accessories						
      	Multi Control white for ComfoAir 200 Touch screen for adjusting the ventilation flow rate, with display of unit parameters. The integrated Wi-Fi allows Multi Control to be displayed and controlled via the Zehnder Multi Controller App. <i>Zehnder Multi Control White 502</i>	-	-	399 000 216	367,00	C
	Multi Control black for ComfoAir 200 Touch screen for adjusting the ventilation flow rate, with display of unit parameters. The integrated Wi-Fi allows Multi Control to be displayed and controlled via the Zehnder Multi Controller App. <i>Zehnder Multi Control Black</i>	-	-	399 000 201	367,00	C
	ComfoSense 67 control panel for ComfoAir 160, 180, 200, 375 and 550 Including cover frame, cover and surface-mounted housing in RAL 9016 <i>CU-CFS67-HSG-9016</i>	30	30	655 010 215	329,10	C
	Remote-controlled control panel as an additional handset for the Sense control panel <i>CU-RF-Z1</i>	150	-	655 000 755	140,80	C
	Dry siphon set for ComfoAir 160, 180, 200 made from white HDPE plastic, variable wastewater connection, closed on suction side <i>SIP-CA160/180/200</i>	20	320	990 201 331	108,00	C
	Filter set for ComfoAir 200, ISO Coarse (G4) 2 pieces <i>FIL-PFR-L292-W24-H150-CRS-2pc</i>	100	200	400 100 014	44,50	K5
	Filter set for ComfoAir 200, ISO Coarse / ISO ePM1 (G4 / F7) 2 pieces <i>FIL-PFR-L292-W24-H150-SET-CRS/ePM1</i>	100	200	400 100 013	47,30	K5

* Energy efficiency class applies in conjunction with two sensors; see overview of energy efficiency classes.

** Energy efficiency class applies in conjunction with one sensor; see overview of energy efficiency classes.

Climos ventilation unit						
Product	Description	PU 1	PU 2	Article no.	Gross price €	Discount group
Climos 200 Eco						
   Passive house certified	Climos 200 Eco F enthalpy comfort ventilation unit 200 m ³ /h (100 Pa) airflow volume, cross-counterflow enthalpy exchanger with integrated pre-heater, EC fans with constant volume flow, without condensate connection, for installation suspended from ceiling or wall, or installation in roof pitch, with control unit. Dimensions: 594 x 1019 x 250 (W x L x H)					
	Climos 200 Eco F enthalpy with left supply connector (type B) <i>CLI200-ERV-COM-ECO-B</i>	-	4	527 006 330	2.871,70	E
	Climos 200 Eco F enthalpy with right supply connector (type A) <i>CLI200-ERV-COM-ECO-A</i>	-	4	527 006 320	2.871,70	E
Climos 200 Eco accessories						
 	Filter set for Climos 200, ISO Coarse (M5) 2 pieces <i>FIL-CLI200-CRS/M5-2PC-PCK</i>	14	280	527 004 270	50,50	K5
	Filter set for Climos 200, ISO Coarse / ISO ePM1 (M5 / F7) 2 pieces <i>FIL-CLI200-CRS/M5-ePM1/F7-2PC-PCK</i>	-	-	527 004 280	53,80	K5













* Energy efficiency class applies in conjunction with one sensor; see overview of energy efficiency classes.

Climos ventilation unit						
Product	Description	PU 1	PU 2	Article no.	Gross price €	Discount group
Climos 200						
  Passive house certified	Climos 200 V enthalpy comfort ventilation unit 200 m³/h (100 Pa) airflow volume, cross-counterflow enthalpy exchanger, EC fans with constant volume flow, without condensate connection, with pre-heater , for installation suspended from ceiling or wall, or installation in roof pitch, without control panel Dimensions: 594 x 1019 x 250 (W x L x H)			 *		
	Climos 200 VL enthalpy with left supply connector (type B) CLI200-ERV-COF-PRH-L	-	4	527 003 270	3.942,60	E
	Climos 200 VR enthalpy with right supply connector (type A) CLI200-ERV-COF-PRH-R	-	4	527 003 260	3.942,60	E
Climos 200 accessories						
	TFT RD control panel with colour touch panel for Climos, Focus, Novus For up to 3 ventilation units Colour: Stainless steel (housing) CU-TSS-RDS-PCK	-	-	521 014 140	538,20	C
	LED RD control panel with membrane keyboard for Climos, Focus, Novus, including cover frame Colour: RAL 9010 CU-LED-RDS-PCK	-	150	521 014 130	278,90	C
	Filter set for Climos 200, ISO Coarse (M5) 2 pieces FIL-CLI200-CRS/M5-2PC-PCK	14	280	527 004 270	50,50	K5
	Filter set for Climos 200, ISO Coarse / ISO ePM1 (M5 / F7) 2 pieces FIL-CLI200-CRS/M5-ePM1/F7-2PC-PCK	-	-	527 004 280	53,80	K5

* Energy efficiency class applies in conjunction with one sensor; see overview of energy efficiency classes.

EVO ventilation units							
Product	Description	PU 1	PU 2	Article no.	Gross price €	Discount group	
EVO 2							
	EVO 2 comfort ventilation unit 200 m³/h (200 Pa) airflow volume, cross-counterflow heat exchanger with automatic bypass, built-in preheater (1 kW), wall-mounted or ceiling-mounted Dimensions: 1000 x 600 x 210 mm (L x W x D)						
	EVO 2 L with supply air connector, left <i>EVO2-HRV-PRHL-Z1-EE</i>	-	7	471 100 085	2.400,00	F1	
	EVO 2 R with supply air connector, right <i>EVO2-HRV-PRH-Z1-EE</i>	-	7	471 100 078	2.400,00	F1	
Passive house certified	EVO 2 enthalpy comfort ventilation unit 200 m³/h (200 Pa) airflow volume, cross-counterflow enthalpy exchanger with automatic bypass, built-in preheater (1 kW), wall-mounted or ceiling-mounted Dimensions: 1000 x 600 x 210 mm (L x W x D)						
	EVO 2 L enthalpy with supply air connector, left <i>EVO2-ERV-PRHL-Z1-EE</i>	-	7	471 100 086	3.100,00	F1	
	EVO 2 R enthalpy with supply air connector, right <i>EVO2-ERV-PRH-Z1-EE</i>	-	7	471 100 079	3.100,00	F1	
EVO 3							
	EVO 3 comfort ventilation unit 300 m³/h (200 Pa) airflow volume, cross-counterflow heat exchanger with automatic bypass, built-in preheater (1 kW), wall-mounted or ceiling-mounted Dimensions: 1160 x 600 x 269 mm (L x W x D)						
	EVO 3 L with supply air connector, left <i>EVO3-HRV-PRH-L-Z1-EE</i>	-	5	471 100 087	2.800,00	F1	
	EVO 3 R with supply air connector, right <i>EVO3-HRV-PRH-Z1-EE</i>	-	5	471 100 083	2.800,00	F1	
Passive house certified	EVO 3 enthalpy comfort ventilation unit 300 m³/h (200 Pa) airflow volume, cross-counterflow enthalpy exchanger with automatic bypass, built-in preheater (1 kW), wall-mounted or ceiling-mounted Dimensions: 1160 x 600 x 269 mm (L x W x D)						
	EVO 3 L enthalpy with supply air connector, left <i>EVO3-ERV-PRH-L-Z1-EE</i>	-	5	471 100 088	3.700,00	F1	
	EVO 3 R enthalpy with supply air connector, right <i>EVO3-ERV-PRH-Z1-EE</i>	-	5	471 100 084	3.700,00	F1	
EVO 4							
	EVO 4 comfort ventilation unit 400 m³/h (200 Pa) airflow volume, cross-counterflow heat exchanger with automatic bypass, built-in preheater (1 kW), wall-mounted or ceiling-mounted Dimensions: 1160 x 600 x 269 mm (L x W x D)						
	EVO 4 L with supply air connector, left <i>EVO4-HRV-PRH-L-Z1-EE</i>	-	5	471 100 089	3.150,00	F1	
	EVO 4 R with supply air connector, right <i>EVO4-HRV-PRH-Z1-EE</i>	-	5	471 100 080	3.150,00	F1	
Passive house certified	EVO 4 enthalpy comfort ventilation unit 400 m³/h (200 Pa) airflow volume, cross-counterflow enthalpy exchanger with automatic bypass, built-in preheater (1 kW), wall-mounted or ceiling-mounted Dimensions: 1160 x 600 x 269 mm (L x W x D)						
	EVO 4 L enthalpy with supply air connector, left <i>EVO4-ERV-PRH-L-Z1-EE</i>	-	5	471 100 090	4.000,00	F1	
	EVO 4 R enthalpy with supply air connector, right <i>EVO4-ERV-PRH-Z1-EE</i>	-	5	471 100 081	4.000,00	F1	

* Energy efficiency classes in accordance with EU Regulation no. 1254/2014; depending on the control unit/type of sensors chosen.

EVO ventilation units						
Product	Description	PU 1	PU 2	Article no.	Gross price €	Discount group
EVO accessories						
	EVO Sense wall-mounted in a 502 or round switch box Connection with the unit via RF Power supply: 230V <i>CU-MLC-LCD-HRU-TMR-RF</i>	-	-	471 100 018	240,00	F1
	EVO Switch wall-mounted in a 502 or round switch box, or directly, with the aid of the integral mounting plate, using expansion plugs Connection with the unit via RF Power supply: CR-2032 battery <i>CU-4POS-RF</i>	-	-	471 100 017	120,00	F1
	EVO CO₂ sensor wall-mounted in a 502 or round switch box Connection with the unit via RF Power supply: 230V <i>SNS-CO2-RF-HRU</i>	-	-	471 100 022	380,00	F1
	EVO humidity sensor wall-mounted in a 502 or round switch box Connection with the unit via RF Power supply: 2xAA batteries <i>SNS-RH--RF-HRU</i>	-	-	471 100 023	230,00	F1
	EVO Connect KNX EVO Connect ModBus is required for using EVO Connect KNX <i>GWY-CVT-CON-KNX</i>	-	-	471 100 024	980,00	F1
	EVO Connect ModBus <i>GWY-RF-RS485/MBS</i>	-	-	471 100 020	230,00	F1
	Multi Control white* for EVO Touch screen for adjusting the ventilation flow rate, with display of unit parameters. The integrated Wi-Fi allows Multi Control to be displayed and controlled via the Zehnder Multi Controller App. <i>Zehnder Multi Control White 502</i>	-	-	399 000 216	367,00	C
	Multi Control black* for EVO Touch screen for adjusting the ventilation flow rate, with display of unit parameters. The integrated Wi-Fi allows Multi Control to be displayed and controlled via the Zehnder Multi Controller App. <i>Zehnder Multi Control Black</i>	-	-	399 000 201	367,00	C
	Dry siphon <i>SIP-DRY-FLX</i>	10	60	471 100 021	60,00	F1
	Filter set for EVO 2 ISO Coarse (G4) 2 pieces <i>FIL-SET-EVO1/2-CRS-2pcs</i>	-	-	471 100 065	34,50	K5
	Filter set for EVO 2 ISO Coarse / ISO ePM1 (G4 / F7) 2 pieces <i>FIL-SET-EVO1/2-1CRS/1ePM1</i>	-	-	471 100 064	37,05	K5
	Filter set for EVO 3 & EVO 4 ISO Coarse (G4) 2 pieces <i>FIL-SET-EVO3/4-CRS-2pcs</i>	-	-	471 100 066	42,80	K5
	Filter set for EVO 3 & EVO 4 ISO Coarse / ISO ePM1 (G4 / F7) 2 pieces <i>FIL-SET-EVO3/4-1CRS/1ePM1</i>	-	-	471 100 067	47,05	K5









* Separate power supply with 12V DC wiring has to be provided (not included).

ComfoAir ventilation units						
Product	Description	PU 1	PU 2	Article no.	Gross price €	Discount group
ComfoAir Standard 375						
	ComfoAir Standard 375 HRV comfort ventilation unit 375 m ³ /h (100 Pa) airflow volume, cross-counterflow heat exchanger with automatic summer bypass 100 %, for wall mounting, incl. wall plate, with pre-heater , different operation options available. Dimensions: 702 x 851 x 572 mm (W x H x D)			** *		
	ComfoAir Standard 375 VL, pre-heater & left supply air connector CA375-BS-L-SD-PRH--MCC7/7	-	4	471 239 610	2.512,40	C
	ComfoAir Standard 375 VR, pre-heater & right supply air connector CA375-BS-R-SD-PRH--MCC7/7	-	4	471 239 611	2.512,40	C
	ComfoAir Standard 375 ERV comfort ventilation unit 375 m ³ /h (100 Pa) airflow volume, cross-counterflow enthalpy exchanger with automatic summer bypass 100 %, for wall mounting, incl. wall plate, with pre-heater , different operation options available. Dimensions: 702 x 851 x 572 mm (W x H x D)			** *		
	ComfoAir Standard 375 VL ERV, pre-heater & left supply air connector CA375-BS-L-SD-PRH-ERV-MCC7/7	-	4	471 239 618	3.218,10	C
	ComfoAir Standard 375 VR ERV, pre-heater & right supply air connector CA375-BS-R-SD-PRH-ERV-MCC7/7	-	4	471 239 619	3.218,10	C
ComfoAir Standard 375 accessories						
	Multi Control white for ComfoAir Standard 375 Touch screen for adjusting the ventilation flow rate, with display of unit parameters. The integrated Wi-Fi allows Multi Control to be displayed and controlled via the Zehnder Multi Controller App. Requires ComfoSense connection cable (400 300 207) <i>Zehnder Multi Control White 502</i>	-	-	399 000 216	367,00	C
	Multi Control black for ComfoAir Standard 375 Touch screen for adjusting the ventilation flow rate, with display of unit parameters. The integrated Wi-Fi allows Multi Control to be displayed and controlled via the Zehnder Multi Controller App. Requires ComfoSense connection cable (400 300 207) <i>Zehnder Multi Control Black</i>	-	-	399 000 201	367,00	C
	ComfoSense 67 control panel for ComfoAir 160, 180, 200, 375 and 550 Including cover frame, cover and surface-mounted housing in RAL 9016 <i>CU-CFS67-HSG-9016</i>	30	30	655 010 215	329,10	C
	ComfoSense connection cable for direct connection of the ComfoSense with built-in time control on the main PCB, length 250 mm <i>CON-CAB-CFS-ELT-PCK</i>	-	100	400 300 207	32,80	C
	CO₂-Sensor V67, 67 mm for In-wall installation cover frame in scope of delivery <i>CO2-SNS-0-10V-67</i>	30	-	655 000 850	248,70	C
	CO₂-Sensor V67, 67 mm for On-wall installation on-wall socket and cover frame in scope of delivery <i>CO2-SNS-0-10V-67-on-wall</i>	30	-	655 000 855	248,70	C
	LUXE PCB upgrade set add-on set for connection on the existing PCB of the ComfoAir Standard ventilation unit for connection of Zehnder CO ₂ sensors <i>KIT-CNV-CA350-BS to LX</i>	-	40	471 230 005	534,70	B
	ComfoAir Standard mounting base <i>FRA-CA350</i>	-	28	642 300 135	194,20	C
	Dry siphon 5 / 4" for ComfoAir 375 and ComfoFond-L Eco <i>SIP-5/4"-CA350/550-CF-L</i>	20	400	990 201 330	64,00	C

* Energy efficiency classes in accordance with EU regulation no. 1253/2014.
 **Energy efficiency classes for ComfoAir Standard are valid in connection with a CO₂ sensor.













ComfoAir ventilation units

Product	Description	PU 1	PU 2	Article no.	Gross price €	Discount group
ComfoAir Standard 375 accessories						
	Filter set for ComfoAir Standard 375 ISO Coarse (G4) 2 pieces <i>FIL-PFR-L500-W16.5-H197-SEL-CRS-2pc</i>	50	300	400 100 085	55,90	K5
	Filter set for ComfoAir Standard 375 ISO Coarse / ISO ePM1 (G4 / F7) 2 pieces <i>FIL-PFR-L500-W16.5-H197-SEL-CRS/ePM1</i>	50	300	400 100 084	59,10	K5
	Filter sets for ComfoAir Standard 375 in 1 box ISO Coarse / ISO ePM1 (G4 / F7) 25 sets / 50 pieces, without manual <i>FIL-CA350/450/550-SET-CRS/ePM1-PBG-25PCS</i>	-	5	400 100 116	1.154,30	K5
	Filter set for ComfoAir Standard 375 ISO Coarse (G4) 10 pieces <i>FIL-PFR-L500-W16.5-H197-SEL-CRS-10PC</i>	1	63	400 100 082	256,00	K5
	Filter set for ComfoAir Standard 375 ISO Coarse (G7) 10 pieces <i>FIL-PFR-L500-W16.5-H197-SEL-ePM1-10PC</i>	-	63	400 100 083	280,00	K5











ComfoAir ventilation units						
Product	Description	PU 1	PU 2	Article no.	Gross price €	Discount group
ComfoAir Flex						
	ComfoAir Flex 250 HRV 250 m³/h (200 Pa) air flow volume, cross counterflow heat exchanger, balanced ventilation unit designed for ceiling mounting. 2-in-1 unit (left/right orientation adjustable via software), low power consumption					
	ComfoAir Flex 250 HRV <i>CAF250-HRV-SI</i>	-	4	471 234 190	3.608,00	CF
 Passive house certified	ComfoAir Flex 250 ERV 250 m³/h (200 Pa) air flow volume, cross counterflow enthalpy exchanger , balanced ventilation unit designed for ceiling mounting. 2-in-1 unit (left/right orientation adjustable via software), low power consumption					
	ComfoAir Flex 250 ERV <i>CAF250-ERV-SI</i>	-	4	471 234 410	4.415,00	CF
	ComfoAir Flex 350 HRV 350 m³/h (200 Pa) air flow volume, cross counterflow heat exchanger, balanced ventilation unit designed for ceiling mounting. 2-in-1 unit (left/right orientation adjustable via software), low power consumption					
	ComfoAir Flex 350 HRV <i>CAF350-HRV-SI</i>	-	4	471 234 205	3.777,10	CF
 Passive house certified	ComfoAir Flex 350 ERV 350 m³/h (200 Pa) air flow volume, cross counterflow enthalpy exchanger , balanced ventilation unit designed for ceiling mounting. 2-in-1 unit (left/right orientation adjustable via software), low power consumption					
	ComfoAir Flex 350 ERV <i>CAF350-ERV-SI</i>	-	4	471 234 415	4.650,00	CF



ComfoAir ventilation units



Product	Description	PU 1	PU 2	Article no.	Gross price €	Discount group
ComfoAir Flex 250/350 accessories						
	ComfoSwitch C67 control panel incl. cover frame, cover and surface-mounted housing in RAL 9016 <i>SW-CNT67-MAC</i>	30	30	655 010 255	157,70	C
	Remote-controlled control panel as an additional handset for the ComfoSense C control panel <i>CU-RF-Z1</i>	150	-	655 000 755	140,80	C
	CO₂-Sensor C67 67 mm for In-wall installation, cover frame in scope of delivery, direct connection via ComfoNet <i>SNS-CO2-67C</i>	30	-	655 000 880	267,30	C
	CO₂-Sensor C67 67 mm for On-wall installation, on-wall socket and cover frame in scope of delivery, direct connection via ComfoNet <i>SNS-CO2-67C-MTB</i>	30	-	655 000 885	267,30	C
	CO₂-Sensor V67 67 mm for In-wall installation, cover frame in scope of delivery <i>CO2-SNS-0-10V-67</i>	30	-	655 000 850	248,70	C
	CO₂-Sensor V67 67 mm for On-wall installation, on-wall socket and cover frame in scope of delivery <i>CO2-SNS-0-10V-67-on-wall</i>	30	-	655 000 855	248,70	C
	ComfoAir RF PCB <i>PCB-RF-CAQ/CAF</i>	-	-	400 502 016	91,10	B
	ComfoAir Flex 250 / 350 pre-heater to increase the outdoor air temperature in winter (heat exchanger frost protection) <i>PRH-CAF-PCK</i>	-	-	400 300 105	625,30	C
	Filter set for ComfoAir Flex 250 / 350, ISO Coarse / ISO ePM1 (G4 / F7) <i>FIL-CAF-ePM1/CRS</i>	-	-	400 100 121	61,50	K5
	Filter set for ComfoAir Flex 250 / 350, ISO Coarse (G4), 2 pieces <i>FIL-CAF-CRS-2PC</i>	-	-	400 100 122	57,40	K5
	Filter set for ComfoAir Flex 250 / 350, ISO Coarse / ISO ePM1 (G4 / F7), 5 pieces <i>FIL-CAF-ePM1-CRS-5PC</i>	-	-	400 100 123	285,00	K5
	Filter set for ComfoAir Flex 250 / 350, ISO ePM1 (F7) 10 pieces <i>FIL-CAF-ePM1-10PC</i>	-	-	400 100 124	314,70	K5
	Filter set for ComfoAir Flex 250 / 350, ISO Coarse (G4) 10 pieces <i>FIL-CAF-CRS-10PC</i>	-	-	400 100 125	263,40	K5

ComfoAir ventilation units



Product	Description	PU 1	PU 2	Article no.	Gross price €	Discount group
ComfoAir E350						
  Passive house certified	ComfoAir E350 V comfort ventilation unit 350 m ³ /h (150 Pa) air volume flow, cross-counterflow heat exchanger with automatic 100% summer by-pass, wall-mounted or floor-mounted using an optional base mount, with pre-heater , display operation Dimensions: 725 x 870 x 560 mm (W x H x D)					
	ComfoAir E350 VL with supply air connector, left	-	4	471 508 125	3.363,30	C
	ComfoAir E350 VR with supply air connector, right	-	4	471 508 130	3363,30	C
	ComfoAir E350 enthalpy comfort ventilation unit 350 m ³ /h (150 Pa) air volume flow, cross-counterflow enthalpy exchanger with automatic 100% summer by-pass, wall-mounted or floor-mounted using an optional base mount, with pre-heater , display operation Dimensions: 725 x 870 x 560 mm (W x H x D)					
	ComfoAir E 350 VL enthalpy, pre-heater & with left supply air connector	-	4	471 508 230	4.038,80	C
	ComfoAir E 350 VR enthalpy, pre-heater & with right supply air connector	-	4	471 508 225	4.038,80	C
ComfoAir E350 accessories						
	Multi Control white for ComfoAir E350 Touch screen for adjusting the ventilation flow rate, with display of unit parameters. The integrated Wi-Fi allows Multi Control to be displayed and controlled via the Zehnder Multi Controller App. <i>Zehnder Multi Control White 502</i>	-	-	399 000 216	367,00	C
	Multi Control black for ComfoAir E350 Touch screen for adjusting the ventilation flow rate, with display of unit parameters. The integrated Wi-Fi allows Multi Control to be displayed and controlled via the Zehnder Multi Controller App. <i>Zehnder Multi Control Black</i>	-	-	399 000 201	367,00	C
	Remote controlled RF control panel required accessories: RF board	150	-	655 000 755	140,80	C
	RF board for RF control panels	30	-	655 000 762	69,10	C
	ComfoAir E350 mounting base	-	60	471 502 008	194,20	C
	Dry siphon 5/4" for ComfoAir E350	20	400	990 201 330	64,00	C
	Filter set for ComfoAir E350, ISO Coarse (G4) 2 pieces	75	225	400 502 012	51,70	K5
	Filter set for ComfoAir E350, ISO Coarse (G4) / ISO ePM1 (F7) contents 2 pieces	58	348	400 502 013	55,90	K5
	Filter set for ComfoAir E350, ISO Coarse (G4) 10 pieces	-	56	400 502 014	231,20	K5
	Filter set for ComfoAir E350, ISO ePM1 (F7) contents 10 pieces	-	42	400 502 015	270,80	K5

* Energy efficiency classes in accordance with EU Regulation no. 1254/2014.
 The energy efficiency class applied when the unit is used with manual control.





ComfoAir ventilation units

Product	Description	PU 1	PU 2	Article no.	Gross price €	Discount group
ComfoAir Q350 TR						
	ComfoAir Q350 TR comfort ventilation unit 350 m ³ /h (200 Pa) airflow volume, cross-counterflow heat exchanger with automatic bypass, six integrated sensors to regulate the volume flow, comfort temperature and humidity. Can be used as right or left unit version. For wall mounting, incl. wall plate and integrated display with graphical user interface, pre-heater available as option; see accessories Dimensions: 775 x 850 x 570 (W x H x D)	-	4	471 502 110	3.596,50	CQ
	ComfoAir Q350 TR enthalpy comfort ventilation unit 350 m ³ /h (200 Pa) airflow volume, cross-counterflow enthalpy exchanger with automatic bypass, six integrated sensors to regulate the volume flow, comfort temperature and humidity. Can be used as right or left unit version. For wall mounting, incl. wall plate and integrated display with graphical user interface, pre-heater available as option; see accessories Dimensions: 775 x 850 x 570 (W x H x D)	-	4	471 502 111	4.444,40	CQ
 	Passive house certified *Energy efficiency class applies in conjunction with two sensors; see overview of energy efficiency classes.					









ComfoAir ventilation units

Product	Description	PU 1	PU 2	Article no.	Gross price €	Discount group
ComfoAir Q450 TR						
	ComfoAir Q450 TR comfort ventilation unit 450 m ³ /h (200 Pa) airflow volume, cross-counterflow heat exchanger with automatic bypass, six integrated sensors to regulate the volume flow, comfort temperature and humidity. Can be used as right or left unit version. For wall mounting, incl. wall plate and integrated display with graphical user interface, pre-heater available as option; see accessories Dimensions: 775 x 850 x 570 (W x H x D)	-	4	471 502 112	4.726,30	CQ
	ComfoAir Q450 TR enthalpy comfort ventilation unit 450 m ³ /h (200 Pa) airflow volume, cross-counterflow enthalpy exchanger with automatic bypass, six integrated sensors to regulate the volume flow, comfort temperature and humidity. Can be used as right or left unit version. For wall mounting, incl. wall plate and integrated display with graphical user interface, pre-heater available as option; see accessories Dimensions: 775 x 850 x 570 (W x H x D)	-	4	471 502 113	5.572,70	CQ
 	Passive house certified *Energy efficiency class applies in conjunction with two sensors; see overview of energy efficiency classes.					









ComfoAir ventilation units





Product	Description	PU 1	PU 2	Article no.	Gross price €	Discount group
ComfoAir Q600 ST						
	ComfoAir Q600 ST comfort ventilation unit 600 m³/h (200 Pa) airflow volume, cross-counterflow heat exchanger with automatic bypass, six integrated sensors to regulate the volume flow, comfort temperature and humidity. Can be used as right or left unit version. For wall mounting, incl. wall plate and integrated display with graphical user interface, pre-heater available as option; see accessories Dimensions: 725 x 850 x 570 (W x H x D)					
	ComfoAir Q600 ST CAQ600-ST-EXP	-	4	471 502 114	5.642,40	CQ
 Passive house certified 	ComfoAir Q600 ST enthalpy comfort ventilation unit 600 m³/h (200 Pa) airflow volume, cross-counterflow enthalpy exchanger with automatic bypass, six integrated sensors to regulate the volume flow, comfort temperature and humidity. Can be used as right or left unit version. For wall mounting, incl. wall plate and integrated display with graphical user interface, pre-heater available as option; see accessories Dimensions: 725 x 850 x 570 (W x H x D)					
	ComfoAir Q600 ST enthalpy CAQ600-ST-ERV-EXP	-	4	471 502 115	6.490,20	CQ

Accessories for ComfoAir Q350/450/600

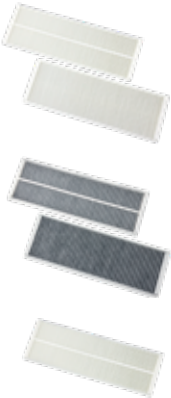
	Multi Control white for ComfoAir Q350/450/600 Touch screen for adjusting and programming the ventilation flow rate, with display of errors and unit parameters. The integrated Wi-Fi allows Multi Control to be displayed and controlled via the Zehnder Multi Controller App. Zehnder Multi Control White 502	-	-	399 000 216	367,00	C
	Multi Control black for ComfoAir Q350/450/600 Touch screen for adjusting and programming the ventilation flow rate, with display of errors and unit parameters. The integrated Wi-Fi allows Multi Control to be displayed and controlled via the Zehnder Multi Controller App. Zehnder Multi Control Black	-	-	399 000 201	367,00	C
	ComfoSense C67 control panel for ComfoAir Q350/450/600 incl. cover frame, cover and surface-mounted housing in RAL 9016 CFS-CNT67-MAC	30	30	655 010 235	329,10	C
	ComfoSwitch C67 control panel for ComfoAir Q350/450/600 incl. cover frame, cover and surface-mounted housing in RAL 9016 SW-CNT67-MAC	30	30	655 010 255	157,70	C
	Remote-controlled control panel as an additional handset for the ComfoSense C control panel CU-RF-Z1	150	-	655 000 755	140,80	C
	CO₂-Sensor C67 , 67 mm for In-wall installation, cover frame in scope of delivery, direct connection via ComfoNet SNS-CO2-67C	30	-	655 000 880	267,30	C
	CO₂-Sensor C67 , 67 mm for On-wall installation, on-wall socket and cover frame in scope of delivery, direct connection via ComfoNet SNS-CO2-67C-MTB	30	-	655 000 885	267,30	C
	CO₂-Sensor V67 , 67 mm for In-wall installation, cover frame in scope of delivery, 0-10V connection, Option Box required CO2-SNS-0-10V-67	30	-	655 000 850	248,70	C
	CO₂-Sensor V67 , 67 mm for On-wall installation, on-wall socket and cover frame in scope of delivery, 0-10V connection, Option Box required CO2-SNS-0-10V-67-on-wall	30	-	655 000 855	248,70	C



* Energy efficiency class applies in conjunction with two sensors; see overview of energy efficiency classes.



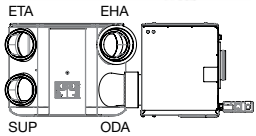
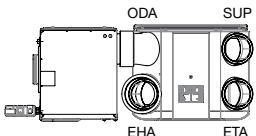

ComfoAir ventilation units						
Product	Description	PU 1	PU 2	Article no.	Gross price €	Discount group
Accessories for ComfoAir Q350/450/600						
	Option Box ComfoAir Q350/450/600 for additional connection options for CO ₂ and humidity sensors as well as ComfoFond-L Q, plug included <i>OPB-CAQ-V2</i>	-	-	471 502 000	220,10	C
	ComfoConnect PRO for control via (Modbus RTU/TCP) with local / remote app control. Compatible with Zehnder ComfoNet II devices and accessories (Zehnder ComfoAir Q, Zehnder ComfoAir Flex, Zehnder ComfoSwitch C /ComfoSense C)	-	-	471 429 300	399,80	C
	ComfoConnect LAN C interface for control via app and web portal (the app is called "ComfoControl" and can be downloaded from the AppStore) <i>GWY-LAN-CNT</i>	30	180	655 011 100	312,20	C
	ComfoConnect KNX C interface for KNX connection options <i>GWY-KNX-CNT</i>	20	40	655 011 120	432,30	C
	Additional board, RF PCB, Q 350/450/600 <i>PCB-RF-CAQ/CAF</i>	-	-	400 502 016	91,10	B
	ComfoAir Q350/450/600 pre-heater to increase the outdoor air temperature in winter (heat exchanger frost protection) <i>PRH-CAQ-PCK</i>	128	128	400 502 007	429,50	C
	ComfoAir Q350/450/600 mounting base Height = 255 mm <i>FRA-CAQ</i>	-	60	471 502 008	194,20	C
	Dry siphon 5/4" for ComfoAir Q350/450/600 <i>SIP-5/4"-CA350/550-CF-L</i>	20	400	990 201 330	64,00	C
	Filter set for ComfoAir Q350/450/600, ISO Coarse (G4) 2 pieces <i>FIL-CAQ-CRS-2PC</i>	75	225	400 502 012	51,70	K5
	Filter set for ComfoAir Q350/450/600, ISO Coarse / ISO ePM1 (G4 / F7), 2 pieces <i>FIL-CAQ-ePM1/CRS</i>	58	348	400 502 013	55,90	K5
	Filter set for ComfoAir Q350/450/600, ISO Coarse / Active coal ePM10, 2 pieces <i>FIL-CAQ-1PC-AC-EPM10-1PC-CRS-PCK</i>	-	250	400 100 097	57,90	K5
	Filter set for ComfoAir Q350/450/600, ISO Coarse (G4) 10 pieces <i>FIL-CAQ-CRS-10PC</i>	-	56	400 502 014	231,20	K5
	Filter set for ComfoAir Q350/450/600, ISO ePM1 (F7) 10 pieces <i>FIL-CAQ-ePM1-10PC</i>	-	42	400 502 015	270,80	K5

ComfoClima						
Product	Description	PU 1	PU 2	Article no.	Gross price €	Discount group
ComfoClima						
	ComfoClima 24 Air-to-Air heat pump, cooling / heating unit. Suitable for air flows from 200 - 400 m ³ /h. Combinable with ComfoAir Q 350 and ComfoAir Q 450 Dimensions: 721 x 850 x 575 (W x H x D) <i>ComfoClima 24</i>	-	2	471 420 010	4.491,60	B
	ComfoClima 36 Air-to-Air heat pump, cooling / heating unit. Suitable for air flows from 300 - 600 m ³ /h. Combinable with ComfoAir Q 450 and ComfoAir Q 600 Dimensions: 721 x 850 x 575 (W x H x D) <i>ComfoClima 36</i>	-	2	471 429 207	4.675,20	B
	ComfoClima Connector for connection of ComfoAir Q 350 & 450 (TR) to ComfoClima <i>CON-CAQ-TR-CC</i>	-	12	990 328 763	163,00	C
	ComfoClima Connector for connection of ComfoAir Q 600 (ST) to ComfoClima <i>CON-CAQ-ST-DN180-CC</i>	-	60	990 328 768	135,80	C

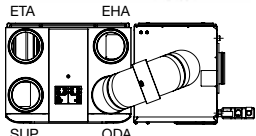
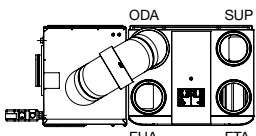

Brine-earth heat exchangers

Product	Description	PU 1	PU 2	Article no.	Gross price €	Discount group
ComfoFond-L Q						
	<p>ComfoFond-L Q TR brine-earth heat exchanger including upstream filter G4 and complete hydraulics for up to 450 m³/h supply air volume flow rate</p> <p>Accessories required: ComfoAir Q350/450/600 option box, dry siphon 5/4"</p> <p>Support frame not included</p>					
	<p>ComfoFond-L Q L TR brine-earth heat exchanger for ComfoAir Q350/450 TR on left <i>CF-LIQ-CAQ-L-SLN</i></p>	-	2	471 310 082	2.490,30	B
	<p>ComfoFond-L Q R TR brine-earth heat exchanger for ComfoAir Q350/450 TR on right <i>CF-LIQ-CAQ-R-SLN</i></p>	-	2	471 310 083	2.490,30	B
ComfoFond-L Q ST brine-earth heat exchanger						
	<p>ComfoFond-L Q ST brine-earth heat exchanger including prefilter G4, complete hydraulics and connecting bend for up to 600 m³/h supply air volume flow rate</p> <p>Accessories required: ComfoAir Q350/450/600 option box, dry siphon 5/4"</p> <p>Support frame not included</p>					
	<p>ComfoFond-L Q L ST brine-earth heat exchanger for ComfoAir Q600 ST on left <i>CF-LIQ-CAQ-L-STT</i></p>	-	2	471 310 084	2.803,50	B
	<p>ComfoFond-L Q R ST brine-earth heat exchanger for ComfoAir Q600 ST on right <i>CF-LIQ-CAQ-R-STT</i></p>	-	2	471 310 085	2.803,50	B

Brine-earth heat exchangers						
Product	Description	PU 1	PU 2	Article no.	Gross price €	Discount group
ComfoFond-L Q accessories						
	Option Box ComfoAir Q350/450/600 for additional connection options for CO ₂ and humidity sensors as well as ComfoFond-L Q, plug included <i>OPB-CAQ-V2</i>	-	-	471 502 000	220,10	C
	ComfoFond-L Q TR floor stand height = 355 mm <i>FRA-CF-LIQ-CAQ-SLN</i>	-	2	471 310 086	224,40	B
	ComfoFond-L Q ST floor stand height = 315 mm <i>FRA-CF-LIQ-CAQ-ST</i>	-	2	471 310 087	224,40	B
	Dry siphon 5/4" for ComfoFond-L Q <i>SIP-5/4"-CA350/550-CF-L</i>	20	400	990 201 330	64,00	C
	Filter for ComfoFond-L Q, ISO Coarse (G4) 1 piece <i>FIL-CRS-SPR-P</i>	50	100	400 100 066	28,70	K5

Enthalpy exchanger						
Product	Description	PU 1	PU 2	Article no.	Gross price €	Discount group
Enthalpy exchanger						
	Enthalpy exchanger for humidity and heat recovery for ComfoAir Q350/450/600/E350 HEX-ERV-370-H500-S-006512-PCK	-	6	400 502 010	1.358,00	B
	for ComfoAir Standard 375 HEX-ERV-366-H378-S-002071-PCK	-	24	400 400 013	1.255,40	B
	for ComfoAir 160 HEX-MOD-ERV-G90/CA160	-	2	400 400 037	1.869,30	B
	for ComfoAir 180 HEX-ERV-366-H200-B-003267-PCK	-	-	400 400 039	1.758,70	B
	for ComfoAir 200 HEX-ERV-450-H310-R-002906-PCK	-	20	400 400 017	1.869,30	B
	for ComfoAir 500/550 and Novus 300/450 HEX-ERV-366_H500-S-000254-PCK	-	18	400 400 014	1.509,80	B
	for Focus 200/250 HEX-ERV-366-H265-S-003097-PCK for Climos 200 HEX-ERV-366-H210-E-003319-CLI200-PCK	-	-	527 007 480 527 003 200	689,30 686,80	B B

Defroster heater, demand control						
Product	Description	PU 1	PU 2	Article no.	Gross price €	Discount group
Defroster heater						
	Iso defroster heater DN 125 with 700 W PTC heating element including ISO Coarse filter ≥ 50% (G3), without control unit PRH-EPP-DN125-700W-CRS/G3	-	-	527 003 450	300,90	C
	Universal thermostat control unit for iso defroster heater including 10 kOhm NTC sensor, cable length 3 m for units with LED control panel UNI-THE-SET-PCK	8	-	521 008 820	387,80	C
	BUS thermostat RD control unit for iso defroster heater including CAT5 cable, 10 kOhm NTC sensor, cable length 3 m for units with TFT control panel BUS-THE-RDS-SET-PCK	-	-	527 004 530	284,50	C
Demand control						
	CO₂-Sensor V67 , 67 mm for In-wall installation, cover frame in scope of delivery CO2-SNS-0-10V-67	30	-	655 000 850	248,70	C
	CO₂-Sensor V67 , 67 mm for On-wall installation, on-wall socket and cover frame in scope of delivery CO2-SNS-0-10V-67-on-wall	30	-	655 000 855	248,70	C

Notes

A large grid of small dots for taking notes, covering most of the page.

always the best climate



RapidLock
Connection

Click!



Zehnder ComfoFresh air distribution system 47 - 74

Connection accessories for ventilation units	48
ComfoWell	49
ComfoCube Flex	52
Overview of example combinations with ComfoCube Flex	54
Silencers	57
ComfoTube Therm insulated air distribution system	58
ComfoWell Therm	61
InFloor air distribution	62
OnFloor air distribution	67
InFloor designer grilles	70
OnFloor designer grilles	72
InFloor and OnFloor designer grilles	73
Service	74

Zehnder RapidLock®

Quick. Easy. Secure: New connection technology for Zehnder air distribution systems



Function:

- **Quick and secure** connection of ventilation tubes ComfoTube 75 and 90 through easy insertion even when turned 90°, thanks to the pre-installed clips
- **Strong connection thanks to smart construction** - RapidLock® prevents unintended loosening of the connection, but allows easy separation for maintenance and cleaning
- **Air-tight connection avoids unwanted leakage**









Advantages:

- Strong, secure and air-tight connection combined with easy application
- Compact design for space saving installation
- Flexible mounting in every building situation
- Easy access for cleaning and maintenance









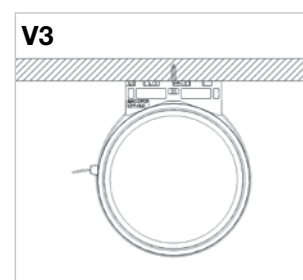
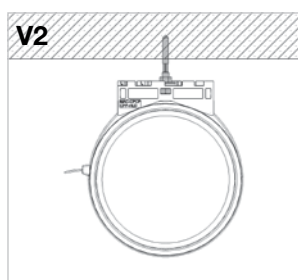
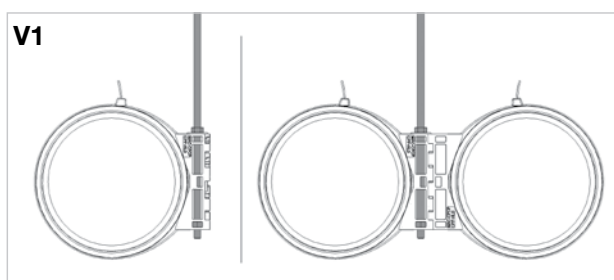



The future of air distribution installation
Discover Zehnder RapidLock®:











Connection accessories for ventilation units





Product	Description	PU 1	PU 2	Article no.	Gross price €	Discount group
ComfoPipe Compact						
	ComfoPipe Compact tube material EPP					
	125 L = 1000 mm, D = 155 / 125 mm <i>TUB-CPCP-DN125-L1m</i>	35	70	990 328 690	52,20	C
	160 L = 1000 mm, D = 190 / 160 mm <i>TUB-CPCP-DN160-L1m</i>	24	48	990 328 693	49,60	C
	200 L = 1000 mm, D = 230 / 200 mm <i>TUB-CPCP-DN200-L1m</i>	15	30	990 328 696	87,40	C
	ComfoPipe Compact bend material EPP					
	125 bend 45° tube, D = 155 / 125 mm <i>BEN-CPCP-DN125x45</i>	96	288	990 328 691	22,60	C
	160 bend 45° tube, D = 190 / 160 mm <i>BEN-CPCP-DN160x45</i>	60	180	990 328 694	19,20	C
	200 bend 45° tube, D = 230 / 200 mm <i>BEN-CPCP-DN200x45</i>	36	108	990 328 697	32,70	C
	ComfoPipe Compact sleeve					
	125 D = 179 / 155 mm <i>CON-CPCP-DN125-M</i>	300	900	990 328 692	20,90	C
	160 D = 214 / 190 mm <i>CON-CPCP-DN160-M</i>	200	600	990 328 695	20,60	C
	200 D = 254 / 230 mm <i>CON-CPCP-DN200-M</i>	120	240	990 328 698	23,20	C
	ComfoPipe Compact double socket					
	125 D = 185 / 155 mm <i>CON-CPCP-DN125-M/M</i>	180	540	990 328 760	20,50	C
	160 D = 220 / 190 mm <i>CON-CPCP-DN160-M/M</i>	120	360	990 328 761	20,40	C
	200 D = 260 / 230 mm <i>CON-CPCP-DN200-M/M</i>	78	234	990 328 762	24,80	C
	ComfoPipe junction 180 mm to 160 mm, material galvanised steel, with seal <i>TRA-SEL-CP-DN180/160</i>	200	200	990 328 664	30,60	C
	ComfoPipe Compact junction 200 mm to 180 mm, junction to connect ComfoFond-L Q ST to ComfoPipe Compact DN 200 <i>TRA-CPP-DN200/180</i>	50	50	990 326 341	35,00	C
Connection accessories						
	ComfoFix Link Tube holder for ComfoPipe DN125, 160 & 200 4pcs PU1 -1 PU2 - I <i>MAC-CPCP-CPP-HLD-4PC</i>	32	512	990 327 300	37,60	C

How ComfoFix Link can be applied.

ComfoWell						
Product	Description	PU 1	PU 2	Article no.	Gross price €	Discount group
    	<p>Silencer without end plates, with highly efficient sound absorption material including clamping rails and fastening material</p> <p>Silencer CW-S 220 dimensions: 500 x 220 x 230 (L x W x D) <i>SIL-CW220</i></p>	-	30	990 323 500	186,00	C
	<p>Silencer CW-S 320 dimensions: 500 x 320 x 230 (L x W x D) <i>SIL-CW320</i></p>	-	24	990 323 501	208,10	C
	<p>Silencer CW-S 420 dimensions: 500 x 420 x 230 (L x W x D) <i>SIL-CW420</i></p>	-	12	990 323 504	243,40	C
	<p>Silencer CW-S 520 dimensions: 500 x 520 x 230 (L x W x D) <i>SIL-CW520</i></p>	-	12	990 323 502	281,70	C
	<p>Silencer CW-S 625 dimensions: 500 x 625 x 230 (L x W x D) <i>SIL-CW625</i></p>	-	12	990 323 505	318,70	C
    	<p>Manifold box without end plates, with sound-absorbing interior lining and inspection plate, for mounting plate, including clamping rails and fastening material</p> <p>Manifold box CW-D 220 dimensions: 230 x 220 x 230 (L x W x D) <i>DIS-CW220-DIV</i></p>	-	32	990 323 530	138,10	C
	<p>Manifold box CW-D 320 dimensions: 230 x 320 x 230 (L x W x D) <i>DIS-CW320-DIV</i></p>	-	32	990 323 531	172,20	C
	<p>Manifold box CW-D 420 dimensions: 230 x 420 x 230 (L x W x D) <i>DIS-CW420-DIV</i></p>	-	24	990 323 620	194,20	C
	<p>Manifold box CW-D 520 dimensions: 230 x 520 x 230 (L x W x D) <i>DIS-CW520-DIV</i></p>	-	20	990 323 532	217,50	C
	<p>Manifold box CW-D 625 dimensions: 230 x 625 x 230 (L x W x D) <i>DIS-CW625-DIV</i></p>	-	16	990 323 630	239,20	C

ComfoWell

Product	Description	PU 1	PU 2	Article no.	Gross price €	Discount group
	Mounting plate for connecting ComfoTube 75 or 90, suitable for manifold box or silencer, including clamping rails. ComfoTube connector made of plastic with increased tightness and stability.					
	Mounting plate CW-M 220-4 x 75/P dimensions: 220 x 40 x 230 (W x H x D), with Zehnder RapidLock ® <i>MPL-CW220-4DN75-RLC</i>	-	308	990 323 610	69,50	C
	Mounting plate CW-M 220-4 x 90/P dimensions: 220 x 40 x 230 (W x H x D), with Zehnder RapidLock ® <i>MPL-CW220-4DN90-RLC</i>	-	308	990 323 611	78,60	C
	Mounting plate CW-M 320-6 x 75/P dimensions: 320 x 40 x 230 (W x H x D), with Zehnder RapidLock ® <i>MPL-CW320-6DN75-RLC</i>	-	220	990 323 612	88,50	C
	Mounting plate CW-M 320-6 x 90/P dimensions: 320 x 40 x 230 (W x H x D), with Zehnder RapidLock ® <i>MPL-CW320-6DN90-RLC</i>	-	220	990 323 613	97,10	C
	Mounting plate CW-M 420-8 x 75/P dimensions: 420 x 40 x 230 (W x H x D), with Zehnder RapidLock ® <i>MPL-CW420-8DN75-RLC</i>	-	154	990 323 621	105,70	C
	Mounting plate CW-M 420-8 x 90/P dimensions: 420 x 40 x 230 (W x H x D), with Zehnder RapidLock ® <i>MPL-CW420-8DN90-RLC</i>	-	154	990 323 622	123,40	C
	Mounting plate CW-M 520-10 x 75/P dimensions: 520 x 40 x 230 (W x H x D), with Zehnder RapidLock ® <i>MPL-CW520-10DN75-RLC</i>	-	154	990 323 614	123,10	C
	Mounting plate CW-M 520-10 x 90/P dimensions: 520 x 40 x 230 (W x H x D), with Zehnder RapidLock ® <i>MPL-CW520-10DN90-RLC</i>	-	154	990 323 615	150,60	C
	Mounting plate CW-M 625-12 x 75/P dimensions: 625 x 40 x 230 (W x H x D), with Zehnder RapidLock ® <i>MPL-CW625-12DN75-RLC</i>	-	110	990 323 631	140,90	C
	Mounting plate CW-M 625-12 x 90/P dimensions: 625 x 40 x 230 (W x H x D), with Zehnder RapidLock ® <i>MPL-CW625-12DN90-RLC</i>	-	110	990 323 632	175,20	C
	Spacer frame for compensating unevenness when fitting to mounting plate, including securing pins					
	Spacer frame CW-DF 220 with clamping rails and sliding part dimensions: 220 x 24 x 230 (W x H x D) <i>MAC-CW220-FRA-MF</i>	10	50	990 323 537	61,60	C
	Spacer frame CW-DF 320 with clamping rails and sliding part dimensions: 320 x 24 x 230 (W x H x D) <i>MAC-CW320-FRA-MF</i>	10	100	990 323 538	65,80	C
	Spacer frame CW-DF 420 with clamping rails and sliding part dimensions: 436 x 28 x 230 (W x H x D) <i>MAC-CW420-FRA-MF</i>	10	60	990 323 624	67,70	C
	Spacer frame CW-DF 520 with clamping rails and sliding part dimensions: 520 x 24 x 230 (W x H x D) <i>MAC-CW520-FRA-MF</i>	10	50	990 323 539	69,50	C
	Spacer frame CW-DF 625 with clamping rails and sliding part dimensions: 641 x 28 x 230 (W x H x D) <i>MAC-CW625-FRA-MF</i>	10	60	990 323 634	72,00	C

ComfoWell						
Product	Description	PU 1	PU 2	Article no.	Gross price €	Discount group
    	End plate with connector, centric, including clamping rails					
	End plate with connector, centric, including clamping rails					
	End plate CW-P 220 – DN 125 dimensions: 220 x 44.3 x 230 (W x H x D) <i>EPL-CW220-DN125</i>	10	160	990 323 510	52,60	C
	End plate CW-P 320 – DN 125 dimensions: 320 x 44.3 x 230 (W x H x D) <i>EPL-CW320-DN125</i>	10	80	990 323 511	65,50	C
	End plate CW-P 320 – DN 160 dimensions: 320 x 44.3 x 230 (W x H x D) <i>EPL-CW320-DN160</i>	10	80	990 323 512	67,20	C
	End plate CW-P 420 – DN 160 dimensions: 420 x 44.3 x 230 (W x H x D) <i>EPL-CW420-DN160</i>	10	100	990 323 627	72,80	C
	End plate CW-P 420 – DN 200 dimensions: 420 x 44.3 x 230 (W x H x D) <i>EPL-CW420-DN200</i>	10	60	990 323 629	81,80	C
	End plate CW-P 520 – DN 160 dimensions: 520 x 44.3 x 230 (W x H x D) <i>EPL-CW520-DN160</i>	10	80	990 323 564	78,00	C
	End plate CW-P 520 – DN 200 dimensions: 520 x 44.3 x 230 (W x H x D) <i>EPL-CW520-DN200</i>	10	80	990 323 514	85,90	C
	End plate CW-P 625 – DN 160 dimensions: 625 x 44.3 x 230 (W x H x D) <i>EPL-CW625-DN160</i>	10	60	990 323 637	83,60	C
End plate CW-P 625 – DN 200 dimensions: 625 x 44.3 x 230 (W x H x D) <i>EPL-CW625-DN200</i>	10	60	990 323 639	90,00	C	



Modular plastic in- and onfloor manifold box Zehnder ComfoCube Flex

Modular plastic in- and onfloor manifold box Zehnder ComfoCube Flex suitable for connection of air ducts for intake and exhaust air up to 300 m³/h.









The manifold box can be assembled from single modules according your needs. The single modules will be connected on-site with clamping strips.





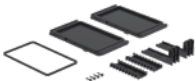





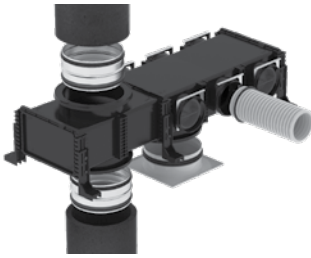
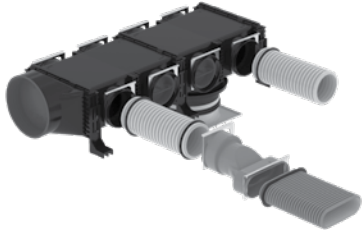

Product	Description	PU 1	PU 2	Article no.	Gross price €	Discount group
Modular plastic in- and onfloor manifold box Zehnder ComfoCube Flex						
	ComfoCube Flex module 4xDN90 , incl. 1 set of clamping strips, 1 set of mounting brackets, 1 module sealing, 4 end caps DN90 & 4 fixing sliders Minimum installation depth: 162 mm dimensions: 300 x 284 x 134mm <i>MOD-CCF-2/2+2-DN90-SET</i>	-	48	990 323 370	86,10	C
	ComfoCube Flex module 4xDN90 with DN160 connection possibility DN160 connection possible from below or as access area incl. 1 set of clamping strips, 1 set of mounting brackets, 1 module sealing, 4 end caps DN90, 4 fixing sliders & 1 DN160 end cap Minimum installation depth: 162 mm dimensions: 300 x 284 x 134mm <i>MOD-CCF-2/2+2/B-DN90-SET</i>	-	72	990 323 371	113,50	C
	ComfoCube Flex module 6xDN90 incl. 1 set of clamping strips, 1 set of mounting brackets, 1 module sealing, 6 end caps DN90 & 6 fixing sliders Minimum installation depth: 162 mm dimensions: 450 x 284 x 134mm <i>MOD-CCF-3/3+3-DN90-SET</i>	-	48	990 323 372	95,00	C
	ComfoCube Flex module 6xDN90 with DN160 connection possibility DN160 connection possible from below or as access area incl. 1 set of clamping strips, 1 set of mounting brackets, 1 module sealing, 6 end caps DN90, 6 fixing sliders & 1 DN160 end cap Minimum installation depth: 162 mm dimensions: 450 x 284 x 134mm <i>MOD-CCF-3/3+3/B.O-DN90-SET</i>	-	54	990 323 373	122,30	C
	ComfoCube Flex shaft module DN160 for top or bottom connection, incl. 1 set of clamping strips, 1 set of mounting brackets, 1 module sealing & 2 DN160 end caps dimensions: 300 x 284 x 134 mm <i>MOD-CCF-2/0+0/B.B-SET</i>	-	12	990 323 374	97,10	C
	ComfoCube Flex frontal connection set DN160 with end plate Outer diameter 160 mm, inner diameter 150mm, incl. 1 set of clamping strips, 1 set of mounting brackets & 1 module sealing Note: Sealing needs to be done via cold shrink film <i>EPL-CCF-L230-W135-H13-SPG-DN160-SET</i>	-	-	990 323 375	44,40	C
	ComfoCube Flex end plate set for bottom connections incl. 1 set of clamping strips, 1 set of mounting brackets and 1 module sealing <i>EPL-CCF-L230-W135-H13-2PC-SET</i>	-	-	990 323 376	42,30	C

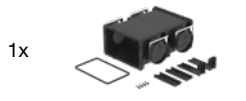
Modular plastic in- and onfloor manifold box Zehnder ComfoCube Flex						
Product	Description	PU 1	PU 2	Article no.	Gross price €	Discount group
Accessories						
	Switchover connector DN 90 to ComfoTube 75 for reduction from DN 90 to ComfoTube 75, incl. 2 O-rings and 2 fixing devices, with Zehnder RapidLock®					
	1 piece <i>TRA-CON-90/75-RLC</i>	150	3000	990 322 010	16,40	C
	10 pieces <i>TRA-CON-90/75-RLC-10PC</i>	8	96	990 322 009	112,80	C
	Junction 90 / 75 to flat 51 for connecting to ComfoTube flat 51 and ComfoTube 90 / 75, including 3 locking slides, with Zehnder RapidLock® Don't include O-rings, must be ordered separately Old article number: 990 322 013 <i>TRA-DN90/75/FL51-RLC</i>	42	672	990 322 204	17,50	C
	Note: for direct connection to the manifold box a 120 mm piece of Zehnder ComfoTube 90 is required.					

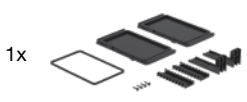

Overview combination examples ComfoCube Flex

<p>Example</p>	 <p>Product</p>	
<p>ComfoCube Flex module 4xDN90 <u>with access area</u> 990 323 371</p>	<p>1x </p>	
<p>ComfoCube Flex module 4xDN90 990 323 370</p>		
<p>ComfoCube Flex module 6xDN90 <u>with access area</u> 990 323 373</p>		<p>1x </p>
<p>ComfoCube Flex riser shaft module DN160 990 323 374</p>		
<p>ComfoCube Flex end plate set for bottom connections 990 323 376</p>	<p>1x </p>	
<p>ComfoCube Flex frontal connection DN160 990 323 375</p>		<p>1x </p>
<p>ComfoFit switchover connector DN90/DN75 10 pcs. 990 322 009</p>	<p>4x </p>	<p>6x </p>
<p>ComfoFit junction 90 / 75 to flat 51 990 322 204</p>		

Overview combination examples ComfoCube Flex

 <p>Manifold 10x ComfoTube 75 with bottom connection and bottom access area DN160</p>	 <p>Manifold 6x ComfoTube 90 with riser shaft module DN160 and bottom access area DN160</p>	 <p>Manifold 4x ComfoTube 90 and 4x ComfoTube flat 51 with side connection DN160 and bottom access area DN160</p>
<p>1x</p> 		<p>1x</p> 
		<p>1x</p> 
<p>1x</p> 	<p>1x</p> 	
	<p>1x</p> 	
<p>1x</p> 	<p>1x</p> 	
		<p>1x</p> 
<p>10x</p> 		
		<p>1x</p> 



Silencers						
Product	Description	PU 1	PU 2	Article no.	Gross price €	Discount group
	CSI rigid silencer highly efficient, special sound absorption material					
		-	24	990 318 245	356,90	C
	CSI 350 DN 160 centric dimensions (L x W x D) 700 x 281 x 197 mm <i>SIL-CSI350-DN160/160-L700</i>					
	CSI 550 DN 200 centric dimensions (L x W x D) 700 x 350 x 230 mm <i>SIL-CSI550-DN200/200-L700</i>	-	15	990 318 251	757,50	C









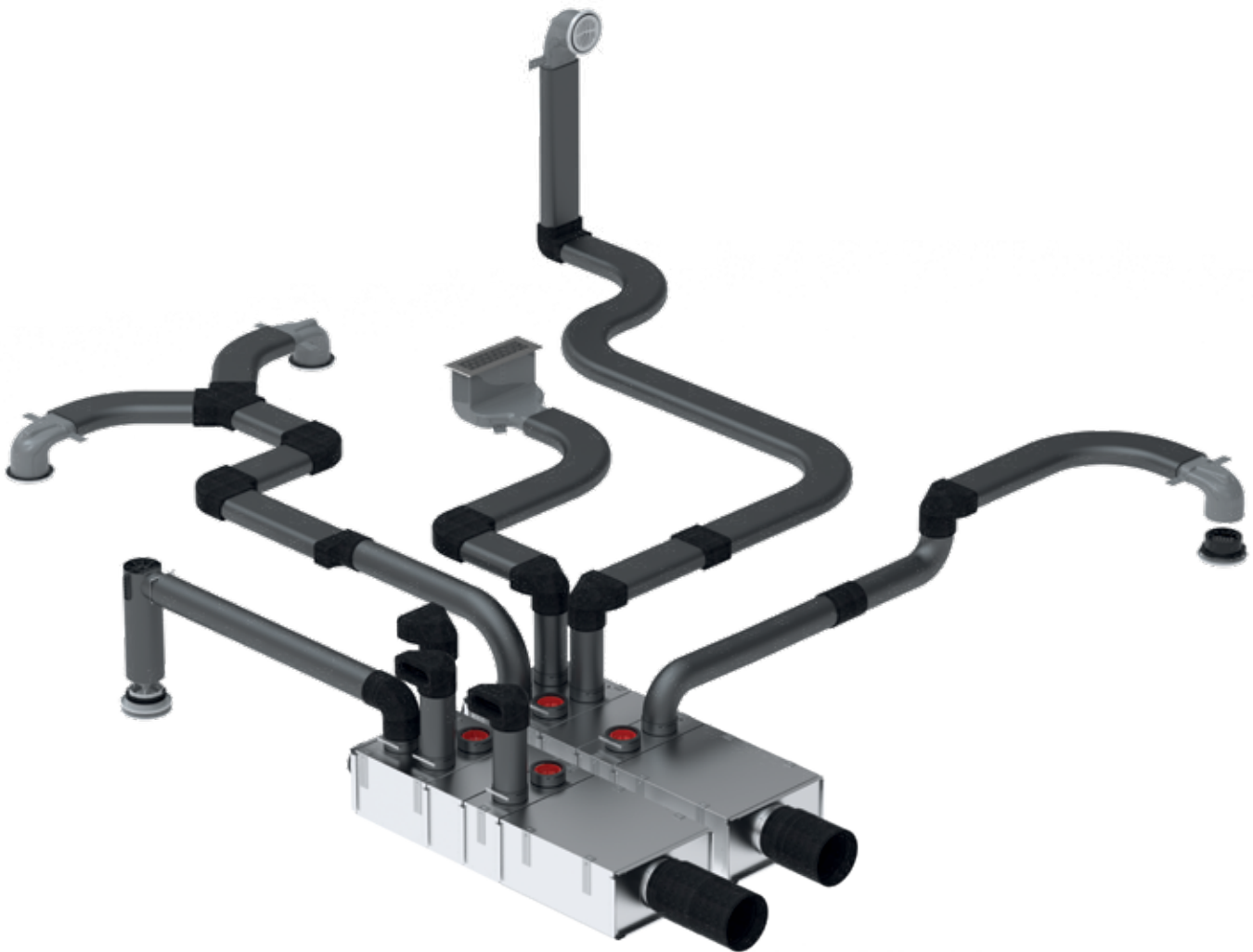

Insulated Air distribution system



















ComfoTube Therm



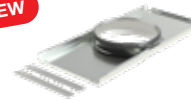

The Zehnder ComfoTube Therm insulated ventilation tube impresses with optimum sound and heat insulation properties for the perfect feel-good climate at home. This makes the ComfoTube Therm the ideal solution for the condensation-free transport of warm and cold air. Thanks to high-quality insulation, the temperature-controlled air is passed through the ventilation tube with almost no temperature loss, so that living spaces can be cooled and heated as required in an energy-efficient manner. The Zehnder ComfoFit Therm insulated connectors, made of expanded polypropylene (EPP), complete the portfolio to form a continuously insulated air distribution system, which is a component of the Zehnder ComfoClima room climate system solution.

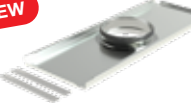





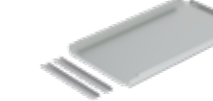

Insulated Air distribution system						
Product	Description	PU 1	PU 2	Article no.	Gross price €	Discount group
ComfoTube Therm						
	ComfoTube Therm 90 Insulated round tube, 20 m roll <i>TUB-CTT-DN90-20m</i>	-	6	990 328 030	542,40	CO
	ComfoTube Therm Flat 51 Insulated flat tube, 10 m roll <i>TUB-CTT-FL51-10m</i>	-	14	990 328 032	376,90	CO
ComfoFit Therm - Connectors						
	ComfoFit Therm connection sleeve 90 <i>CON-CFT-DN90-M</i>	112	448	990 430 855	19,70	CO
	ComfoFit Therm bend 90 <i>BEN-CFT-DN90x90-HOR</i>	48	192	990 430 856	43,40	CO
	ComfoFit Therm sleeve Flat 51 <i>CON-CFT-FL51-M</i>	135	540	990 430 854	25,20	CO
	ComfoFit Therm bend Flat 51, horizontal <i>BEN-CFT-FL51x90-HOR</i>	62	248	990 430 851	32,00	CO
	ComfoFit Therm bend Flat 51, vertical <i>BEN-CFT-FL51x90-VER</i>	76	304	990 430 850	31,30	CO
	ComfoFit Therm Y-piece Flat 51 <i>YPI-CFT-FL51/FL51/FL51</i>	42	168	990 430 853	61,50	CO
	ComfoFit Therm junction 90 to Flat 51 <i>TRA-CFT-FL51/DN90</i>	69	276	990 430 857	34,00	CO
	ComfoFit Therm junction 90 to Flat 51, 90° bend <i>TRA-CFT-FL51/DN90x90</i>	60	240	990 430 852	30,20	CO
	Rubber seal ComfoTube Therm 90 <i>SEL-CT-DN90-10PC</i>	80	3360	990 328 363	23,90	C







Insulated Air distribution system







Product	Description	PU 1	PU 2	Article no.	Gross price €	Discount group
ComfoWell Therm						
 	ComfoWell Therm mounting plate CW320, 6xDN90 with internal insulation 320 mm x 230 mm x 80 mm, with Zehnder RapidLock® <i>MPL-CWT320-6DN90-RLC-INS</i>	-	-	990 430 879	116,00	C
 	ComfoWell Therm end plate CW320 DN160 with internal insulation 320 mm x 230 mm x 60 mm <i>EPL-CWT320-DN160-INS</i>	-	-	990 430 880	86,00	C
 	ComfoWell Therm mounting plate CW420, 8xDN90 with internal insulation 420 mm x 230 mm x 80 mm, with Zehnder RapidLock® <i>MPL-CWT420-8DN90-RLC-INS</i>	-	-	990 430 872	126,00	C
 	ComfoWell Therm mounting plate CW520, 10xDN90 with internal insulation 520 mm x 230 mm x 80 mm, with Zehnder RapidLock® <i>MPL-CWT520-10DN90-RLC-INS</i>	-	-	990 430 873	155,00	C
 	ComfoWell Therm end plate CW520 DN160 with internal insulation 520 mm x 230 mm x 60 mm <i>EPL-CWT520-DN160-INS</i>	-	-	990 430 874	94,00	C
 	ComfoWell Therm end plate CW520 DN200 with internal insulation 520 mm x 230 mm x 60 mm <i>EPL-CWT520-DN160-INS</i>	-	-	990 430 875	104,00	C
 	ComfoWell Therm mounting plate CW625, 12xDN90 with internal insulation 625 mm x 230 mm x 80 mm, with Zehnder RapidLock® <i>MPL-CWT625-12DN90-RLC-INS</i>	-	-	990 430 876	179,00	C
 	ComfoWell Therm end plate CW625 DN160 with internal insulation 625 mm x 230 mm x 60 mm <i>EPL-CWT625-DN160-INS</i>	-	-	990 430 877	104,00	C
 	ComfoWell Therm end plate CW625 DN200 with internal insulation 625 mm x 230 mm x 60 mm <i>EPL-CWT625-DN200-INS</i>	-	-	990 430 878	114,00	C







Insulated Air distribution system						
Product	Description	PU 1	PU 2	Article no.	Gross price €	Discount group
ComfoWell Therm 420						
	ComfoWell Therm extension module 4x90, with Zehnder RapidLock ® <i>DIS-CWT420-4DN90-RLC</i>	-	18	990 430 860	252,50	CO
	ComfoWell Therm extension module 2x90, with Zehnder RapidLock ® <i>DIS-CWT420-2DN90-RLC</i>	-	30	990 430 858	179,20	CO
	ComfoWell Therm extension module <i>DIS-CWT420</i>	-	30	990 430 859	134,40	CO
	ComfoWell Therm closed plate <i>EPL-CWT420-BLI</i>	10	90	990 430 861	68,70	CO
	ComfoWell Therm end plate DN 160 <i>EPL-CWT420-DN160-INS</i>	-	90	990 430 862	74,20	CO
	ComfoWell Therm end plate DN 200 <i>EPL-CWT420-DN200-INS</i>	5	80	990 430 870	74,20	CO
	ComfoWell Therm end cap 90 <i>CAP-CWT-DN90-2PC</i>	50	200	990 430 865	8,80	CO



InFloor air distribution

















Product	Description	PU 1	PU 2	Article no.	Gross price €	Discount group
	ComfoTube Flex 75 ventilation tube made of special PE, highly flexible, easy to clean, with inner skin, Ø 75 mm 50 m TUB-CT-DN75-50m-FX	-	6	990 328 094	235,00	D
	ComfoTube Flex 90 ventilation tube made of special PE, highly flexible, easy to clean, with inner skin, Ø 90 mm 50 m TUB-CT-DN90-50m-FX	-	5	990 328 096	294,00	D
	Click sleeve for installation-friendly ComfoTube connection Click sleeve DN 75 CON-CT-DN75-M	50	600	990 328 107	10,10	C
	Click sleeve DN 90 CON-CT-DN90-M	50	600	990 328 109	11,40	C
	End cap for ComfoTube to protect against dirt during construction 10 pieces End cap DN 75 CAP-CT-DN75-10PC	10	500	990 328 262	44,10	C
	End cap DN 90 CAP-CT-DN90-10PC	10	200	990 328 263	54,20	C
	End cap for closing ComfoWell, ComfoCube Flex manifold unused connections 10 pieces End cap DN 75 CAP-CON-DN75-10PC	42	336	990 326 138	13,50	C
	End cap DN 90 CAP-CON-DN90-10PC	28	224	990 326 139	14,40	C
	O-ring seal for sealing ComfoTube sleeve 10 pieces O-ring seal DN 75 SEL-CT-DN75-10PC	100	3600	990 328 362	23,60	C
	O-ring seal DN 90 SEL-CT-DN90-10PC	80	3360	990 328 363	23,90	C
	ComfoTube 75 tube holder for fastening ventilation tubes, with integrated locking and stacking function 10 pieces MAC-DN75-HLD-10PC	74	222	990 327 200	26,70	C
	ComfoTube 90 tube holder for fastening ventilation tubes, with integrated locking and stacking function 10 pieces MAC-DN90-HLD-10PC	47	141	990 327 201	30,90	C

InFloor air distribution						
Product	Description	PU 1	PU 2	Article no.	Gross price €	Discount group
	ComfoTube 90° bend for narrow bends in the ComfoTube pipeline, bend can be shortened and thus used directly in the mounting plate, including 2 locking slides Don't include O-rings, must be ordered separately					
	for ComfoTube 75 with Zehnder RapidLock® <i>BEN-CT-DN75x90-RLC</i>	30	360	990 322 152	23,80	C
	for ComfoTube 90 with Zehnder RapidLock® <i>BEN-CT-DN90x90-RLC</i>	30	360	990 322 153	28,00	C
	Junction 90 / 75 to flat 51 for connecting to ComfoTube flat 51 and ComfoTube 90 / 75, including 3 locking slides, with Zehnder RapidLock® Don't include O-rings, must be ordered separately Old article number: 990 322 013 <i>TRA-DN90/75/FL51-RLC</i>	42	672	990 322 204	17,50	C
	Junction 90 to flat 51, 90° bend for vertical 90° bend, connection to ComfoTube flat 51 and ComfoTube 90, including 2 locking slides, with Zehnder RapidLock® Don't include O-rings, must be ordered separately Old article number: 990 322 046 <i>TRA-FL51/DN90x90-RLC</i>	36	576	990 322 205	17,50	C
	Junction 2 x 75 to flat 51 for connecting to ComfoTube flat 51 and ComfoTube 75, including 3 locking slides, with Zehnder RapidLock® Don't include O-rings, must be ordered separately Old article number: 990 322 150 <i>TRA-CT-FL51/2DN75-RLC</i>	40	360	990 322 206	24,40	C
	ComfoTube 75/90 cross-piece for crossing ComfoTube 75/90, with Zehnder RapidLock® Don't include O-rings, must be ordered separately Old article number: 990 322 155 <i>TRA-ADJ-4XDN90/75-RLC</i>	5	60	990 322 208	46,70	C
	ComfoSet 75 airflow regulator for ComfoTube 75 <i>RES-CT-CS-DN75</i>	25	1200	990 320 026	15,00	C
	ComfoSet 90 airflow regulator for ComfoTube 90 <i>RES-CT-CS-DN90</i>	25	1200	990 320 027	17,70	C











InFloor air distribution						
Product	Description	PU 1	PU 2	Article no.	Gross price €	Discount group
Grille housing TVA-P						
	TVA-P 75 grille housing for connecting valve DN 125 to ComfoTube 2 x DN 75, including guard, mounting bracket, locking slide, with Zehnder RapidLock® Connection length = 64 mm <i>OUT-TVA-2DN75-RLC-Z-DN125-SHRT</i>	12	144	990 326 149	33,00	C
	For designer grilles					
	TVA-P 75 grille housing for connecting valve DN 125 to ComfoTube 2 x DN 75, including guard, mounting bracket, locking slide, with Zehnder RapidLock® Connection length = 300 mm <i>OUT-TVA-2DN75-RLC-Z-DN125-LNG</i>	7	56	990 326 150	33,00	C
	For designer grilles					
	TVA-P 90 grille housing for connecting valve DN 125 to ComfoTube 1 x DN 90, including guard, mounting bracket, locking slide, with Zehnder RapidLock® Connection length = 64 mm <i>OUT-TVA-DN90-RLC-Z-DN125-SHRT</i>	-	-	990 326 144	33,00	C
	For designer grilles					
	TVA-P 90 grille housing for connecting valve DN 125 to ComfoTube 1 x DN 90, including guard, mounting bracket, locking slide, with Zehnder RapidLock® Connection length = 300 mm <i>OUT-TVA-DN90-RLC-Z-DN125-LNG</i>	10	80	990 326 146	33,00	C
	For designer grilles					
	TVA-P 90 grille housing for connecting valve DN 125 / design grille to ComfoTube 2 x DN 90, including guard, mounting bracket, locking slide, with Zehnder RapidLock® Connection length = 300 mm <i>OUT-TVA-2DN90-RLC-Z-DN125-LNG</i>	6	48	990 326 148	36,00	C
	For designer grilles					
	TVA-P 90 frontal for connecting valve DN 125 / design grille to ComfoTube 1 x DN 90, including guard, mounting bracket, locking slide, with Zehnder RapidLock® Connection length = 160 mm <i>OUT-TVA-DN90-RLC-C-DN125</i>	24	162	990 326 141	31,00	C
	For designer grilles					
	Mounting set DN 125 for securing grille housing to the concrete framework TVA-P 75 (990 326 149) and TVA-P 90 (990 326 144) including attachment nails <i>MAC-TVA-DN125-MF-SET</i>	30	1200	990 326 153	14,70	C





InFloor air distribution						
Product	Description	PU 1	PU 2	Article no.	Gross price €	Discount group
Grille housing CLD-P						
	Grille housing CLD-P 75 for connecting to ComfoTube DN 75, including guard, mounting bracket, distance plate and locking slide Height = 85 mm , frontal sleeve <i>OUT-CLD/P-DN75-A-H85-DS-MAC</i>	30	360	990 320 810	128,70	C
	Grille housing CLD-P 75 for connecting to ComfoTube DN 75, including guard, mounting bracket, distance plate and locking slide Height = 85 mm, lateral sleeve <i>OUT-CLD/P-DN75-B-H85-DS-MAC</i> Height = 115 mm, lateral sleeve <i>OUT-CLD/P-DN75-B-H115-DS-MAC</i>	24 30	240 240	990 320 811 990 320 813	138,10 138,10	C C
	Grille housing CLD-P 90 for connecting to ComfoTube DN 90, including guard, mounting bracket, distance plate and locking slide Height = 115 mm , frontal sleeve <i>OUT-CLD/P-DN90-A-H115-DS-MAC</i>	36	260	990 320 845	138,10	C
	Grille housing CLD-P 90 for connecting to ComfoTube DN 90, including guard, mounting bracket, distance plate and locking slide Height = 115 mm, lateral sleeve <i>OUT-CLD/P-DN90-B-H115-DS-MAC</i> Height = 140 mm, lateral sleeve <i>OUT-CLD/P-DN90-B-H140-DS-MAC</i>	30 20	300 240	990 320 846 990 320 852	146,40 146,40	C C
Grille housing CLD-P wide						
	Grille housing CLD-P 75 wide for connecting to ComfoTube 3 x DN 75 Height = 115 mm, lateral connectors with Zehnder RapidLock ® <i>OUT-CLD-3DN75-B-RLC-H115</i>	-	120	990 320 533	240,90	C
	Grille housing CLD-P 90 wide for connecting to ComfoTube 2 x DN 90 Height = 115 mm, lateral connectors with Zehnder RapidLock ® <i>OUT-CLD-2DN90-B-RLC-H115</i> Height = 140 mm, lateral connectors with Zehnder RapidLock ® <i>OUT-CLD-2DN90-B-RLC-H140</i>	- -	96 84	988 320 507 988 320 527	220,30 220,30	C C

InFloor air distribution						
Product	Description	PU 1	PU 2	Article no.	Gross price €	Discount group
Inductive vents						
	Slot diffuser ComfoGrid Linea 400 for supply and extract air, wall and ceiling mounting (not suitable for floor mounting), suitable for housing CSB-P 400. Dimensions: 436 x 76,5 mm					
	Model: ComfoGrid Linea 400 Black, glas optics, black <i>DGR-CSB/P-L400-W75-Linea-Black</i>	12	96	990 321 790	246,20	C
	Model: ComfoGrid Linea 400 White, glas optics, white <i>DGR-CSB/P-L400-W75-Linea-White</i>	12	96	990 321 791	246,20	C
	Model: ComfoGrid Linea 400 Inox, stainless steel <i>DGR-CSB/P-L400-W75-Linea-Inox</i>	12	96	990 321 792	202,10	C
	Slot diffuser ComfoGrid Linea 600 for supply and extract air, wall and ceiling mounting (not suitable for floor mounting), suitable for housing CSB-P 600. Dimensions: 636 x 76,5 mm					
	Model: ComfoGrid Linea 600 Black, glas optics, black <i>DGR-CSB/P-L600-W75-Linea-Black</i>	12	108	990 321 793	303,10	C
	Model: ComfoGrid Linea 600 White, glas optics, white <i>DGR-CSB/P-L600-W75-Linea-White</i>	12	108	990 321 794	303,10	C
	Model: ComfoGrid Linea 600 Inox, stainless steel <i>DGR-CSB/P-L600-W75-Linea-Inox</i>	12	108	990 321 795	245,00	C
 	ComfoCase CSB-P 400 for slot diffuser ComfoGrid Linea, Lamina and Bilamina, for connection to 2 x round tube Zehnder ComfoTube 75 or 1 x round tube Zehnder ComfoTube 90, wall- and ceiling mounting possible (not suitable for floor mounting), lateral connection. Height = 182 mm <i>OUT-CSB/P-2DN75-DN90-B-L410</i>	8	96	990 321 745	80,90	C
	ComfoCase CSB-P 600 for connection to 2 x round tube Zehnder ComfoTube 90 or 1 x round tube Zehnder ComfoTube 110 (ComfoTube 110 and components on request), wall and ceiling mounting (not suitable for floor mounting), lateral connection. Height = 182 mm <i>OUT-CSB/P-2DN90-DN110-B-L610</i>	8	72	990 321 746	118,80	C
	Mounting bracket for housing CSB-P 400 and 600 for wall mounting and suspended ceilings. Content: 2 pieces <i>MAC-CSB-MB</i>	-	50	988 321 646	61,80	C
	Switchover connector DN 90 to ComfoTube 75 for housing CSB-P 600, for reduction from DN 90 to ComfoTube 75, incl. 2 O-rings and 2 fixing devices, with Zehnder RapidLock ® <i>TRA-CON-90/75-RLC</i>	150	3000	990 322 010	16,40	C







OnFloor air distribution						
Product	Description	PU 1	PU 2	Article no.	Gross price €	Discount group
OnFloor air distribution						
 	ComfoMain twin duct CK150 (CK300) for connecting unit distribution manifolds to walls, floors and ceilings. Not suitable for concreting L=1.5 m, black, polymer <i>TUB-CK150-1,5m-2PC</i>	40	40	990 322 051	59,00	C
 	ComfoMain twin duct Plus CK150 (CK300) for connecting unit distribution manifolds to walls, floors and ceilings. Not suitable for concreting L=1 m, black, set of 2xCK150 <i>TUB-CK150-1M-2PC</i>	-	-	990 322 052	58,00	C
	CK 300 flexible element for flexible connection to twin duct CK 300 including a lip seal. Used as flexible bend (up to 45°) and as height offset for twin duct CK 300 <i>CON-CK300-FLEX</i>	12	144	990 328 821	41,30	C
	CK 300 twin duct nipple for connecting twin duct CK 300, including 4 lip seals <i>CON-CK300-N</i>	10	120	990 322 023	18,70	C
	Twin duct bend CK 300 H for horizontal 90° bend, including 4 lip seals <i>BEN-CK300x90-HOR</i>	10	60	990 322 021	29,00	C
	Twin duct bend CK 300 V for vertical 90° bend, including 4 lip seals <i>BEN-CK300x90-VER</i>	10	120	990 322 022	24,90	C
	Junction CK 300 / DN 160 adapter for twin duct CK 300 to pipe DN 160, including 2 lip seals <i>TRA-DN160/CK300</i>	5	160	990 322 025	43,80	C
	Junction CK 300 / DN 125 adapter for twin duct CK 300 to pipe DN 125, including 2 lip seals <i>TRA-DN125/CK300</i>	35	210	990 322 029	43,80	C
	Twin duct cap CK 300 end cap to protect against dirt during construction, for twin duct CK 300 <i>CAP-CK300</i>	136	1632	990 322 024	8,20	C
	Lip seal CK 300 for CK 300 duct, 10 pieces <i>SEL-CK300-10PC</i>	80	640	990 322 026	39,60	C
 	flat 51 6-port manifold for supply or extract air system, with 6 ComfoTube flat 51 connectors, including 6 locking slides, with access panel, with Zehnder RapidLock® Don't include O-rings, must be ordered separately Old article number: 990 322 030 <i>DIS-6FL51-RLC</i>	10	40	990 322 221	244,70	C
 	flat 51 4-port manifold for supply or extract air system, with 4 ComfoTube flat 51 connectors, including 4 locking slides, with access panel, with Zehnder RapidLock® Don't include O-rings, must be ordered separately Old article number: 990 322 031 <i>DIS-4FL51-RLC</i>	10	60	990 322 220	153,40	C
 	Adapter CK 300/DN 160 Adapter double duct CK 300 to pipe DN 160 for vertical deflection 90° incl. 3 lip seals <i>TRA-DN160/CK300x90</i>	6	72	990 322 049	61,20	C



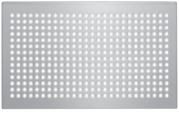

OnFloor air distribution

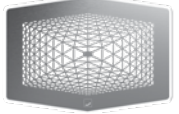
Product	Description	PU 1	PU 2	Article no.	Gross price €	Discount group
	ComfoTube flat 51 ventilation tube made from PE easy to clean, with smooth inner skin, 51 x 138 mm 50 m <i>TUB-CT-FL51-50m</i>	-	4	990 328 078	816,90	D
	flat 51 sleeve for installation-friendly ComfoTube connection, including locking slides, with Zehnder RapidLock® Don't include O-rings, must be ordered separately Old article number: 990 322 014 <i>CON-CT-FL51-M-RLC</i>	57	912	990 322 202	14,00	C
	Bend flat 51 H for horizontal 90° bend, connects to ComfoTube flat 51, including 2 locking slides, with Zehnder RapidLock® Don't include O-rings, must be ordered separately <i>BEN-FL51x90-HOR-RLC</i>	36	324	990 322 201	22,40	C
	Bend flat 51 V for vertical 90° bend, connects to ComfoTube flat 51, including 2 locking slides, with Zehnder RapidLock® Don't include O-rings, must be ordered separately Old article number: 990 322 011 <i>BEN-FL51x90-VER-RLC</i>	36	576	990 322 200	20,10	C
	Junction 90 / 75 to flat 51 for connecting to ComfoTube flat 51 and ComfoTube 90 / 75, including 3 locking slides, with Zehnder RapidLock® Don't include O-rings, must be ordered separately Old article number: 990 322 013 <i>TRA-DN90/75/FL51-RLC</i>	42	672	990 322 204	17,50	C
	Junction 90 to flat 51, 90° bend for vertical 90° bend, connection to ComfoTube flat 51 and ComfoTube 90, including 2 locking slides, with Zehnder RapidLock® Don't include O-rings, must be ordered separately Old article number: 990 322 046 <i>TRA-FL51/DN90x90-RLC</i>	36	576	990 322 205	17,50	C
	Junction 2 x 75 to flat 51 for connecting to ComfoTube flat 51 and ComfoTube 75, including 3 locking slides, with Zehnder RapidLock® Don't include O-rings, must be ordered separately Old article number: 990 322 150 <i>TRA-CT-FL51/2DN75-RLC</i>	40	360	990 322 206	24,40	C
	Y piece flat 51 for branch, connection to ComfoTube flat 51, including 3 locking slides, air volume max. 45 m³/h at normal ventilation level, with Zehnder RapidLock® Don't include O-rings, must be ordered separately Old article number: 990 322 151 <i>YPI-FL51/FL51/FL51-RLC</i>	14	168	990 322 203	34,30	C
	Cross-piece flat 51 for crossing flat 51, including 4 locking slides, with Zehnder RapidLock® Don't include O-rings, must be ordered separately Old article number: 990 322 154 <i>TRA-ADJ-4xFL51-RLC</i>	9	108	990 322 207	51,20	C
	End cap flat 51 for ComfoTube 51 to protect against dirt during installation 10 pieces <i>CAP-CT-FL51-10PC</i>	10	160	990 328 252	69,80	C
	O-ring seal for sealing ComfoTube flat 51 10 pieces <i>SEL-CT-FL51-CTD-10PC</i>	100	3600	990 328 352	23,50	C
	Mounting bracket flat 51 10 pieces <i>MAC-FL51-MB-10PC</i>	50	300	990 322 016	47,30	C





OnFloor air distribution						
Product	Description	PU 1	PU 2	Article no.	Gross price €	Discount group
	ComfoSet flat 51 air flow regulator <i>RES-CT-CS-FL51</i>	25	1200	990 322 015	25,10	C
	Grille housing CLF for wall, floor or ceiling installation, connection for ComfoTube flat 51, including locking slide, with Zehnder RapidLock® Don't include O-ring, must be ordered separately Old article number: 990 322 000 <i>OUT-CLF-FL51-RLC</i>	8	64	990 322 210	54,30	C
	CLRF round grille housing, lateral connects to ComfoTube flat 51 with 90° bend, for wall and ceiling mounting, including locking slide, with Zehnder RapidLock® Don't include O-ring, must be ordered separately Old article number: 990 322 060 <i>OUT-CLRF-FL51-Z-RLC-DN125-H358</i>	12	108	990 322 211	53,90	C
	CLRF round grille housing, lateral 2x connection to ComfoTube flat 51, with Zehnder RapidLock® Don't include O-rings, must be ordered separately Old article number: 990 322 063 <i>OUT-CLRF-2FL51-Z-RLC-DN125</i>	12	108	990 322 215	67,80	C
	Round grille housing CLRF, frontal straight connection to ComfoTube flat 51 bend, for wall and ceiling installation, including locking slide, with Zehnder RapidLock® Don't include O-ring, must be ordered separately Old article number: 990 322 061 <i>OUT-CLRF-FL51-C-RLC-DN125</i>	12	144	990 322 216	53,90	C

InFloor designer grilles







Product	Description	PU 1	PU 2	Article no.	Gross price €	Discount group
 Zehnder Roma	Supply and extract air designer grille dimensions: 260 x 160 mm, suitable for CLD-P, CLD-WC for installation in walls, ceilings and floors					
	ComfoGrid Roma decorative grille, stainless steel <i>DGR-CLD-L260-W160-Roma-INOX</i>	20	-	990 320 610	51,70	C
	ComfoGrid Roma decorative grille, RAL 9016 (not suitable for use as a floor grille) <i>DGR-CLD-L260-W160-Roma-9016</i>	20	-	990 320 611	51,70	C
 Zehnder Pisa	Supply and extract air designer grille dimensions: 260 x 160 mm, suitable for CLD-P, CLD-WC for installation in walls, ceilings and floors					
	ComfoGrid Pisa decorative grille, stainless steel <i>DGR-CLD-L260-W160-Pisa-INOX</i>	20	-	990 320 620	51,70	C
	ComfoGrid Pisa decorative grille, RAL 9016 (not suitable for use as a floor grille) <i>DGR-CLD-L260-W160-Pisa-9016</i>	20	-	990 320 621	51,70	C
 Zehnder Venezia	Supply and extract air designer grille dimensions: 260 x 160 mm, suitable for CLD-P, CLD-WC for installation in walls, ceilings and floors					
	ComfoGrid Venezia decorative grille, stainless steel <i>DGR-CLD-L260-W160-Venezia-INOX</i>	20	-	990 320 640	51,70	C
	ComfoGrid Venezia decorative grille, RAL 9016 (not suitable for use as a floor grille) <i>DGR-CLD-L260-W160-Venezia-9016</i>	20	-	990 320 641	51,70	C
 Zehnder Bologna	Supply and extract air designer grille dimensions: 260 x 160 mm, suitable for CLD, including filter for installation in walls, ceilings and floors					
	ComfoGrid Bologna decorative grille, stainless steel <i>DGR-CLD-L260-W160-FIL-Bologna-INOX</i>	20	-	990 322 315	52,50	C
	ComfoGrid Bologna decorative grille, RAL 9016 (not suitable for use as a floor grille) <i>DGR-CLD-L260-W160-FIL-Bologna-9016</i>	20	-	990 322 314	52,50	C
 Zehnder Topazio	Supply and extract air designer grille dimensions: 270 mm x 170 mm, suitable for CLD, including filter for installation in walls and ceilings, not suitable for floors					
	ComfoGrid Topazio decorative grille, stainless steel <i>DGR-CLD-L270-W170-FIL-Topazio-INOX</i>	20	-	990 322 333	114,00	C
	ComfoGrid Topazio decorative grille, RAL 9016 <i>DGR-CLD-L270-W170-FIL-Topazio-9016</i>	20	-	990 322 332	114,00	C
 Zehnder Rubino	Supply and extract air designer grille dimensions: 270 x 192 mm, suitable for CLD, including filter for installation in walls and ceilings, not suitable for floors					
	ComfoGrid Rubino decorative grille, stainless steel <i>DGR-CLD-L270-W192-FIL-Rubino-INOX</i>	20	-	990 322 343	130,00	C
	ComfoGrid Rubino decorative grille, RAL 9016 <i>DGR-CLD-L270-W192-FIL-Rubino-9016</i>	20	-	990 322 342	130,00	C
 Zehnder Milano	Supply and extract air designer grille dimensions: 290 x 170 mm, suitable for CLD, including filter for installation in walls, ceilings and floors					
	ComfoGrid Milano decorative grille, stainless steel <i>DGR-CLD-L290-W170-FIL-Milano-INOX</i>	20	-	990 322 305	51,00	C
	ComfoGrid Milano decorative grille, RAL 9016 (not suitable for use as a floor grille) <i>DGR-CLD-L290-W170-FIL-Milano-9016</i>	20	-	990 322 304	51,00	C
 Zehnder Zaffiro	Supply and extract air designer grille dimensions: 305 x 180 mm, suitable for CLD, including filter for installation in walls and ceilings, not suitable for floors					
	ComfoGrid Zaffiro decorative grille, stainless steel <i>DGR-CLD-L305-W180-FIL-Zaffiro-INOX</i>	20	-	990 322 323	114,00	C
	ComfoGrid Zaffiro decorative grille, RAL 9016 <i>DGR-CLD-L305-W180-FIL-Zaffiro-9016</i>	20	-	990 322 322	114,00	C

InFloor designer grilles						
Product	Description	PU 1	PU 2	Article no.	Gross price €	Discount group
 Zehnder Pisa	Supply and extract air designer grille dimensions: 430 x 160 mm, suitable for CLD wide, for installation in walls, ceilings and floors					
	ComfoGrid Pisa decorative grille, stainless steel <i>DGR-CLD-L430-W160-Pisa-INOX</i> ComfoGrid Pisa decorative grille, RAL 9016 (not suitable for use as a floor grille) <i>DGR-CLD-L430-W160-Pisa-9016</i>	10	-	990 320 624	65,80	C
 Zehnder Venezia	Supply and extract air designer grille dimensions: 430 x 160 mm, suitable for CLD wide, for installation in walls, ceilings and floors					
	ComfoGrid Venezia decorative grille, stainless steel <i>DGR-CLD-L430-W160-Venezia-INOX</i>	10	-	990 320 648	65,80	C
 Zehnder Roma	Supply and extract air designer grille dimensions: 430 x 160 mm, suitable for CLD wide, for installation in walls, ceilings and floors					
	ComfoGrid Roma decorative grille, stainless steel <i>DGR-CLD-L430-W160-Roma-INOX</i> ComfoGrid Roma decorative grille, RAL 9016 (not suitable for use as a floor grille) <i>DGR-CLD-L430-W160-Roma-9016</i>	- 10	-	990 320 617 990 320 618	65,80 65,80	C C
 Zehnder Bologna	Supply and extract air designer grille dimensions: 430 x 160 mm, suitable for CLD, including filter for installation in walls, ceilings and floors					
	ComfoGrid Bologna decorative grille, stainless steel <i>DGR-CLD-L430-W160-FIL-Bologna-INOX</i> ComfoGrid Bologna decorative grille, RAL 9016 (not suitable for use as a floor grille) <i>DGR-CLD-L430-W160-FIL-Bologna-9016</i>	20 20	-	990 322 317 990 322 316	74,00 74,00	C C
 Zehnder Milano	Supply and extract air designer grille dimensions: 460 x 170 mm, suitable for CLD wide, including filter for installation in walls, ceilings and floors					
	ComfoGrid Milano decorative grille, stainless steel <i>DGR-CLD-L460-W170-FIL-Milano-INOX</i> ComfoGrid Milano decorative grille, RAL 9016 (not suitable for use as a floor grille) <i>DGR-CLD-L460-W170-FIL-Milano-9016</i>	20 20	-	990 322 307 990 322 306	68,00 68,00	C C

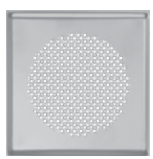









OnFloor designer grilles

Product	Description	PU 1	PU 2	Article no.	Gross price €	Discount group
 <p>Zehnder Bologna</p>	Supply and extract air designer grille dimensions: 340 x 130 mm, suitable for CLF for installation in walls, ceilings and floors					
	ComfoGrid Bologna decorative grille, stainless steel <i>DGR-CLF-L340-W130-Bologna-INOX</i> ComfoGrid Bologna decorative grille, RAL 9016 (not suitable for use as a floor grille) <i>DGR-CLF-L340-W130-Bologna-9016</i>	20	-	990 322 313	70,00	C
 <p>Zehnder Roma</p>	Supply and extract air designer grille dimensions: 350 x 130 mm, suitable for CLF, for installation in walls, ceilings and floors					
	ComfoGrid Roma decorative grille, stainless steel <i>DGR-CLF-L350-W130-Roma-INOX</i> ComfoGrid Roma decorative grille, RAL 9016 (not suitable for use as a floor grille) <i>DGR-CLF-L350-W130-Roma-9016</i>	10	-	990 322 081	69,10	C
 <p>Zehnder Pisa</p>	Supply and extract air designer grille dimensions: 350 x 130 mm, suitable for CLF, for installation in walls, ceilings and floors					
	ComfoGrid Pisa decorative grille, stainless steel <i>DGR-CLF-L350-W130-Pisa-INOX</i> ComfoGrid Pisa decorative grille, RAL 9016 (not suitable for use as a floor grille) <i>DGR-CLF-L350-W130-Pisa-9016</i>	10	-	990 322 083	69,10	C
 <p>Zehnder Venezia</p>	Supply and extract air designer grille dimensions: 350 x 130 mm, suitable for CLF, for installation in walls, ceilings and floors					
	ComfoGrid Venezia decorative grille, stainless steel <i>DGR-CLF-L350-W130-Venezia-INOX</i> ComfoGrid Venezia decorative grille, RAL 9016 (not suitable for use as a floor grille) <i>DGR-CLF-L350-W130-Venezia-9016</i>	10	-	990 322 087	69,10	C
 <p>Zehnder Milano</p>	Supply and extract air designer grille dimensions: 360 x 140 mm, suitable for CLF for installation in walls, ceilings and floors					
	ComfoGrid Milano decorative grille, stainless steel <i>DGR-CLF-L360-W140-Milano-INOX</i> ComfoGrid Milano decorative grille, RAL 9016 (not suitable for use as a floor grille) <i>DGR-CLF-L360-W140-Milano-9016</i>	20	-	990 322 303	69,00	C

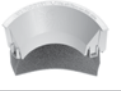

Round InFloor and OnFloor designer grilles

Product	Description	PU 1	PU 2	Article no.	Gross price €	Discount group
 Zehnder Venezia	Round designer grille, extract air with filter, connector DN 125, suitable for CLRF / TVA, Ø 160 mm, for installation in walls and ceilings, not for floors ComfoGrid Venezia, stainless steel (not suitable for use as a floor grille) <i>DGR-DIV-DN125/160-FIL-Venezia-INOX</i> ComfoGrid Venezia, RAL 9016 (not suitable for use as a floor grille) <i>DGR-DIV-DN125/160-FIL-Venezia-9016</i>	10	-	990 320 780	51,00	C
	ComfoGrid Venezia, RAL 9016 (not suitable for use as a floor grille) <i>DGR-DIV-DN125/160-FIL-Venezia-9016</i>	10	-	990 320 781	51,00	C
 Zehnder Venezia	Square designer grille, extract air with filter, connector DN 125, suitable for CLRF / TVA, 160 x 160 mm, for installation in walls and ceilings, not for floors ComfoGrid Venezia, stainless steel (not suitable for use as a floor grille) <i>DGR-DIV-DN125/L160-W160-FIL-Venezia-INOX</i> ComfoGrid Venezia, RAL 9016 (not suitable for use as a floor grille) <i>DGR-DIV-DN125-Q160-FIL-Venezia-9016</i>	10	-	990 322 089	51,00	C
	ComfoGrid Venezia, RAL 9016 (not suitable for use as a floor grille) <i>DGR-DIV-DN125-Q160-FIL-Venezia-9016</i>	10	-	990 322 090	51,00	C
 Zehnder Milano	Round designer grille, extract air with filter, connector DN 125, suitable for CLRF / TVA, Ø 160 mm, for installation in walls and ceilings, not for floors ComfoGrid Milano decorative grille, stainless steel <i>DGR-DIV-DN125/160-FIL-Milano-INOX</i> ComfoGrid Milano decorative grille, RAL 9016 <i>DGR-DIV-DN125/160-FIL-Milano-9016</i>	24	-	990 322 301	48,00	C
	ComfoGrid Milano decorative grille, RAL 9016 <i>DGR-DIV-DN125/160-FIL-Milano-9016</i>	24	-	990 322 300	48,00	C
 Zehnder Bologna	Round designer grille, extract air with filter, connector DN 125, suitable for CLRF / TVA, Ø 160 mm, for installation in walls and ceilings, not for floors ComfoGrid Bologna decorative grille, stainless steel <i>DGR-DIV-DN125/160-FIL-Bologna-INOX</i> ComfoGrid Bologna decorative grille, RAL 9016 <i>DGR-DIV-DN125/160-FIL-Bologna-9016</i>	24	-	990 322 311	56,00	C
	ComfoGrid Bologna decorative grille, RAL 9016 <i>DGR-DIV-DN125/160-FIL-Bologna-9016</i>	24	-	990 322 310	56,00	C
 Zehnder Zaffiro	Round designer grille, extract air with filter, connector DN 125, suitable for CLRF / TVA, Ø 160 mm, for installation in walls and ceilings, not for floors ComfoGrid Zaffiro decorative grille, stainless steel <i>DGR-DIV-DN125/160-FIL-Zaffiro-INOX</i> ComfoGrid Zaffiro decorative grille, RAL 9016 <i>DGR-DIV-DN125/160-FIL-Zaffiro-9016</i>	24	-	990 322 321	92,00	C
	ComfoGrid Zaffiro decorative grille, RAL 9016 <i>DGR-DIV-DN125/160-FIL-Zaffiro-9016</i>	24	-	990 322 320	92,00	C
 Zehnder Topazio	Square designer grille, extract air with filter, connector DN 125, suitable for CLRF / TVA, 160 x 160 mm, for installation in walls and ceilings, not for floors ComfoGrid Topazio decorative grille, stainless steel <i>DGR-DIV-DN125/160-FIL-Topazio-INOX</i> ComfoGrid Topazio decorative grille, RAL 9016 <i>DGR-DIV-DN125/160-FIL-Topazio-9016</i>	24	-	990 322 331	92,00	C
	ComfoGrid Topazio decorative grille, RAL 9016 <i>DGR-DIV-DN125/160-FIL-Topazio-9016</i>	24	-	990 322 330	92,00	C
 Zehnder Rubino	Designer grille, extract air with filter, connector DN 125, suitable for CLRF / TVA, Ø 160 mm, for installation in walls and ceilings, not for floors ComfoGrid Rubino decorative grille, stainless steel <i>DGR-DIV-DN125/160-FIL-Rubino-INOX</i> ComfoGrid Rubino decorative grille, RAL 9016 <i>DGR-DIV-DN125/160-FIL-Rubino-9016</i>	24	-	990 322 341	99,00	C
	ComfoGrid Rubino decorative grille, RAL 9016 <i>DGR-DIV-DN125/160-FIL-Rubino-9016</i>	24	-	990 322 340	99,00	C
	Filter set DN 125, ISO Coarse (G3) suitable for extract air valves and designer grilles CLRF / TVA 10 pieces <i>FIL-DIV-DN125-CRS-10PC</i>	122	366	990 320 032	33,10	K5

InFloor and OnFloor valves

Product	Description	PU 1	PU 2	Article no.	Gross price €	Discount group
    	Supply air valve ComfoValve Luna S125 DN 125, Ø 170, suitable for CLRF/TVA-P Plastic, white <i>VAL-SUP-LUN1-DN125-PLS-9003</i>	24	384	705 613 126	40,80	C
	Supply air valve ComfoValve Luna S125 - bulk pack of 24 DN 125, Ø 170, suitable for CLRF / TVA-P, plastic, white (bulk pack of 24) <i>VAL-SUP-LUN1-DN125-PLS-9003-24PC</i>	-	16	705 613 125	805,70	C
	Supply air valve ComfoValve Luna S125 DN 125, Ø 170, suitable for CLRF/TVA-P Plastic, black <i>VAL-SUP-LUN1-DN125-PLS-black</i>	24	384	705 613 135	44,90	C
	AirBlocker outflow restrictor suitable for ComfoValve Luna S125, for restricting the outflow angle to 240° <i>RES-LUN1-DN125</i>	150	2400	705 613 001	14,20	C
     	Extract air valve ComfoValve Luna E125 DN 125, Ø 170, suitable for CLRF/TVA-P Plastic, white <i>VAL-ETA-LUN-DN125-PLS-9003</i>	24	288	705 613 128	40,60	C
	Extract air valve ComfoValve Luna E125 - bulk pack of 24 DN 125, Ø 170, suitable for CLRF/ TVA-P, plastic, white, without filter (bulk pack of 24) <i>VAL-ETA-LUN-DN125-PLS-9003-24PC</i>	1	12	705 613 129	802,90	C
	Extract air valve ComfoValve Luna E125 DN 125, Ø 170, suitable for CLRF / TVA-P Plastic, black <i>VAL-ETA-LUN-DN125-PLS-black</i>	24	288	705 613 133	44,90	C
	Filter set DN 100, ISO Coarse (G3) suitable for Luna E125, extract valves and designer grilles 10 pieces <i>FIL-DIV-DN100-CRS-10PC</i>	20	400	990 320 031	30,00	K5
Filter set DN 125, ISO Coarse (G3) suitable for extract air valves and designer grilles CLRF / TVA 10 pieces <i>FIL-DIV-DN125-CRS-10PC</i>	122	366	990 320 032	33,10	K5	

Service

Product	Description	Article no.	Gross price €	Discount group
	Air distribution cleaning set suitable for ComfoTube 75 / 90 and flat 51. Including adapter for grille housing CLD(-P), CLF, CLRF and TVA(-P) as well as vacuum cleaner connectors, reel length 15 metres <i>UTL-BRU-SET</i>	990 000 106	2 000,90	B
	ComfoTool Pipe cutter ComfoTube DN75 / DN90 <i>UTL-CT-DN75/90</i>	990 000 110	31,10	C
	CO₂ data logger for measuring and recording carbon dioxide, air temperature and humidity in closed interiors. Including time and date display, plug, USB data cable, PC software. <i>MEQ-CO2</i>	990 000 100	203,60	net

Notes

A large grid of small dots for taking notes, covering most of the page.

always the best climate





Zehnder outdoor and exhaust air

78 - 79

Outdoor air and exhaust air connectors

78

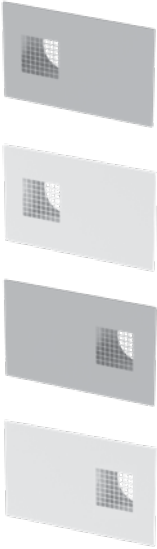
Facade system						
Product	Description	PU 1	PU 2	Article no.	Gross price €	Discount group
Outdoor air / exhaust air connector						
	External wall grille for wall installation DN 125 up to 200 m ³ /h <i>EAC-DN125-200M3H-L248-W267-H37-INOX</i> DN 160 up to 450 m ³ /h <i>EAC-DN160-350M3H-L280-W280-H37-INOX</i> DN 200 up to 600 m ³ /h <i>EAC-DN200-500M3H-L330-W330-H37-INOX</i>	20	100	990 430 250	103,50	C
		20	80	990 430 584	108,80	C
		20	60	990 430 585	150,60	C
	Combined external ComfoEdge Dupla DN125 for compact connection of the outdoor and exhaust air in one element ComfoEdge Dupla combined external wall grille right, galvanised sheet steel connector DN 125, nominal air volume 120 m ³ /h <i>EAC-DN125-EHA-ODA-R-Dupla-INOX</i>	-	40	990 430 573	261,40	C
	ComfoEdge Dupla combined external wall grille right, galv. sheet steel, RAL 9016 connector DN 125, nominal air volume 120 m ³ /h <i>EAC-DN125-EHA-ODA-R-Dupla-9016</i>	-	40	990 430 571	273,70	C
	ComfoEdge Dupla combined external wall grille left, galvanised sheet steel connector DN 125, nominal air volume 120 m ³ /h <i>EAC-DN125-EHA-ODA-L-Dupla-INOX</i>	-	-	990 430 572	261,40	C
	ComfoEdge Dupla combined external wall grille left, galv. sheet steel, RAL 9016 connector DN 125, nominal air volume 120 m ³ /h <i>EAC-DN125-EHA-ODA-L-Dupla-9016</i>	-	-	990 430 570	273,70	C
	Combined external ComfoEdge Dupla DN 160 for compact connection of the outdoor and exhaust air in one element ComfoEdge Dupla combined external wall grille right, galvanised sheet steel connector DN 160, nominal air volume 270 m ³ /h <i>EAC-DN160-EHA-ODA-R-Dupla-INOX</i>	-	22	990 430 577	351,60	C
	ComfoEdge Dupla combined external wall grille right, galv. sheet steel, RAL 9016 connector DN 160, nominal air volume 270 m ³ /h <i>EAC-DN160-EHA-ODA-R-Dupla-9016</i>	-	22	990 430 575	368,00	C
	ComfoEdge Dupla combined external wall grille left, galvanised sheet steel connector DN 160, nominal air volume 270 m ³ /h <i>EAC-DN160-EHA-ODA-L-Dupla-INOX</i>	-	22	990 430 576	351,60	C
	ComfoEdge Dupla combined external wall grille left, galv. sheet steel, RAL 9016 connector DN 160, nominal air volume 270 m ³ /h <i>EAC-DN160-EHA-ODA-L-Dupla-9016</i>	-	-	990 430 574	368,00	C

Facade system

Product	Description	PU 1	PU 2	Article no.	Gross price €	Discount group
---------	-------------	------	------	-------------	---------------	----------------

Outdoor air / exhaust air connector

	<p>Combined external wall grille DN 125 for compact connection of the outdoor and exhaust air in one element</p> <p>ComfoEdge combined external wall grille right, stainless steel connector DN 125 up to 200 m³/h nominal flow <i>EAC-DN125-EHA-ODA-R-INOX</i></p>	-	50	990 430 591	188,80	C
	<p>ComfoEdge combined external wall grille right, stainless steel, RAL 9016 connector DN 125 up to 200 m³/h <i>EAC-DN125-EHA-ODA-R-9016</i></p>	-	50	990 430 599	205,30	C
	<p>ComfoEdge combined external wall grille left, stainless steel connector DN 125 up to 200 m³/h nominal flow <i>EAC-DN125-EHA-ODA-L-INOX</i></p>	-	50	990 430 592	188,80	C
	<p>ComfoEdge combined external wall grille left, stainless steel, RAL 9016 connector DN 125 up to 200 m³/h <i>EAC-DN125-EHA-ODA-L-9016</i></p>	-	50	990 430 598	205,30	C
	<p>Combined external wall grille DN 160 for compact connection of the outdoor and exhaust air in one element</p> <p>Outdoor air connector right, connector DN 160 up to 300 m³/h nominal flow <i>EAC-DN160-EHA-ODA-R-INOX</i></p> <p>Outdoor air connector left, connector DN 160 up to 300 m³/h nominal flow <i>EAC-DN160-EHA-ODA-L-INOX</i></p>	-	12	990 430 594	253,70	C
	<p>ComfoEdge combined external wall grille DN200 up to 400m³/h nominal air flow rate for compact connection of the outdoor air and exhaust air in one element. External dimensions: 676 x 337 x 212 mm Drill hole distance, centre to centre: 328.5 mm Ø Drill hole: min. 240 mm (ComfoPipe Compact), min. 290 mm (ComfoPipe Plus)</p> <p>ComfoEdge combined external wall grille, DN200, exhaust air connection right, stainless steel <i>EAC-DN200-EHA-ODA-R-INOX</i></p>	-	10	990 430 596	317,10	C
	<p>ComfoEdge combined external wall grille, DN200, exhaust air connection left, stainless steel <i>EAC-DN200-EHA-ODA-L-INOX</i></p>	-	10	990 430 597	317,10	C

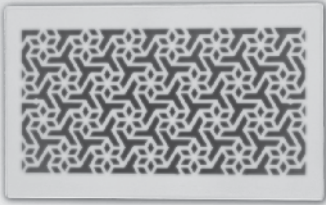



























Zehnder replacement filters

















82 – 86











Replacement filters for ventilation units	82
Filter box	85
Replacement filters for heating elements, brine-earth heat exchangers, air distribution	86







Replacement filters for ventilation units

Product	Description	PU 1	PU 2	Article no.	Gross price €	Discount group
ComfoSpot 50						
	 Filter set for ComfoSpot 50, ISO Coarse (G4), 2 pieces <i>FIL-CSP50-CRS/G4-2PC-PCK</i>	28	560	527 005 390	31,40	K5
	 Pollen filter set for ComfoSpot 50, ISO Coarse / ISO ePM10 (G4 / F7) 2 pieces <i>FIL-CSP50-CRS/G4-ePM10/F7-2PC-PCK</i>	-	-	527 005 400	34,20	K5
	 Filter set for ComfoSpot 50, ISO Coarse (G4), 10 pieces <i>FIL-CSP50-CRS/G4-10PC-PCK</i>	-	-	527 005 410	118,50	K5
	 Pollen filter set for ComfoSpot 50, ISO Coarse / ISO ePM10 (G4 / F7) 10 pieces <i>FIL-CSP50-CRS/G4-ePM10/F7-10PC</i>	-	-	527 005 420	130,00	K5
ComfoAir 70						
	 Filter set for ComfoAir 70, ISO Coarse (G4), 2 pieces <i>FIL-CA70-CRS/G4-2PC-PCK</i>	28	448	527 005 180	34,30	K5
	 Pollen filter set for ComfoAir 70, ISO Coarse / ISO ePM10 (G4 / F7) 2 pieces <i>FIL-CA70-CRS/G4-ePM10/F7-2PC-PCK</i>	28	560	527 005 190	38,00	K5
	 Filter set for ComfoAir 70, ISO Coarse (G4), 10 pieces <i>FIL-CA70-CRS/G4-10PC</i>	14	280	527 005 160	128,40	K5
	 Pollen filter set for ComfoAir 70, ISO Coarse / ISO ePM10 (G4 / F7) 10 pieces <i>FIL-CA70-CRS/G4-ePM10/F7-10PC</i>	-	-	527 005 170	138,10	K5

Replacement filters for ventilation units								
Product	Description	PU 1	PU 2	Article no.	Gross price €	Discount group		
ComfoAir 160								
		Filter set for ComfoAir 160, ISO Coarse (G4), 2 pieces <i>FIL-CA160-SET-CRS/CRS</i>		50	150	400 100 023	44,50	K5
		Pollen filter set for ComfoAir 160, ISO Coarse / ISO ePM1 (G4 / F7) 2 pieces <i>FIL-CA160-SET-CRS/ePM1</i>		100	300	400 100 024	47,30	K5
ComfoAir 180								
		Filter set for ComfoAir 180, ISO Coarse (G4), 2 pieces <i>FIL-CA180-SET-CRS/CRS</i>		160	350	400 100 090	44,50	K5
		Pollen filter set for ComfoAir 180, ISO Coarse / ISO ePM1 (G4 / F7) 2 pieces <i>FIL-SET-CA180-SET-CRS/EPM1</i>		160	240	400 100 091	47,30	K5
ComfoAir 200								
		Filter set for ComfoAir 200, ISO Coarse (G4), 2 pieces <i>FIL-PFR-L292-W24-H150-CRS-2pc</i>		100	200	400 100 014	44,50	K5
		Pollen filter set for ComfoAir 200, ISO Coarse / ISO ePM1 (G4 / F7) 2 pieces <i>FIL-PFR-L292-W24-H150-SET-CRS/ePM1</i>		100	200	400 100 013	47,30	K5
Climos 200, Climos 200 Eco								
		Filter set for Climos 200, ISO Coarse (M5), 2 pieces <i>FIL-CLI200-CRS/M5-2PC-PCK</i>		14	280	527 004 270	50,50	K5
		Pollen filter set for Climos 200, ISO Coarse / ISO ePM1 (M5 / F7) 2 pieces <i>FIL-CLI200-CRS/M5-ePM1/F7-2PC-PCK</i>		-	-	527 004 280	53,80	K5
Focus 200, Focus 250 Base								
		Filter set for Focus 200 / 250, ISO Coarse (G4) 2 pieces <i>FIL-FCS-CRS/G4-2PC-PCK</i>		20	400	527 004 260	47,30	K5
		Pollen filter set for Focus 200 / 250, ISO Coarse / ISO ePM1 (G4 / F7) 2 pieces <i>FIL-FCS-CCP-CRS/G4-ePM1/F7-2PC-PCK</i>		20	400	527 003 430	52,40	K5
		Filter set for Focus 200 / 250, ISO ePM1 (F7) 10 pieces <i>FIL-FCS-CCP-ePM1/F7-10PC-PCK</i>		-	-	527 009 750	234,80	K5

Replacement filters for ventilation units							
Product	Description	PU 1	PU 2	Article no.	Gross price €	Discount group	
ComfoAir Standard 375							
	 Filter set for ComfoAir Standard 375, ISO Coarse (G4) 2 pieces <i>FIL-PFR-L500-W16.5-H197-SEL-CRS-2pc</i>	50	300	400 100 085	55,90	K5	
	 Pollen filter set for ComfoAir Standard 375, ISO Coarse / ISO ePM1 (G4 / F7) 2 pieces <i>FIL-PFR-L500-W16.5-H197-SEL-CRS/ePM1</i>	50	300	400 100 084	59,10	K5	
	 25 sets of filters Coarse/ G4+ePM1/ F7 in 1 box, suitable for ComfoAir 375 and ComfoFond-L Q, box consists of 50 filters without manual <i>FIL-CA350/450/550-SET-CRS/ePM1-PBG-25PCS</i>	-	5	400 100 116	1.154,30	K5	
	 Filter set for ComfoAir Standard 375 ISO Coarse (G4) 10 pieces <i>FIL-PFR-L500-W16.5-H197-SEL-CRS-10PC</i>	1	63	400 100 082	256,00	K5	
	 Filter set for ComfoAir Standard 375 ISO Coarse (G7) 10 pieces <i>FIL-PFR-L500-W16.5-H197-SEL-ePM1-10PC</i>	-	63	400 100 083	280,00	K5	
ComfoAir Flex 250 / 350							
	 Filter set for ComfoAir Flex 250 / 350 ISO Coarse / ISO ePM1 (G4 / F7) 2 pieces <i>FIL-CAF-ePM1/CRS</i>	-	-	400 100 121	61,50	K5	
	 Filter set for ComfoAir Flex 250 / 350, ISO Coarse (G4) 2 pieces <i>FIL-CAF-CRS-2PC</i>	-	-	400 100 122	57,40	K5	
	 Filter set for ComfoAir Flex 250 / 350, ISO Coarse / ISO ePM1 (G4 / F7) 5 pieces <i>FIL-CAF-ePM1-CRS-5PC</i>	-	-	400 100 123	285,00	K5	
	 Filter set for ComfoAir Flex 250 / 350 ISO ePM1 (F7) 10 pieces <i>FIL-CAF-ePM1-10PC</i>	-	-	400 100 124	314,70	K5	
	 Filter set for ComfoAir Flex 250 / 350 ISO Coarse (G4) 10 pieces <i>FIL-CAF-CRS-10PC</i>	-	-	400 100 125	263,40	K5	
EVO							
	 Filter set for EVO 2 ISO Coarse (G4) 2 pieces <i>FIL-SET-EVO1/2-CRS-2pcs</i>	-	-	471 100 065	34,50	K5	
	 Filter set for EVO 2 ISO Coarse / ISO ePM1 (G4 / F7) 2 pieces <i>FIL-SET-EVO1/2-1CRS/1ePM1</i>	-	-	471 100 064	37,05	K5	
	 Filter set for EVO 3 & EVO 4 ISO Coarse (G4) 2 pieces <i>FIL-SET-EVO3/4-CRS-2pcs</i>	-	-	471 100 066	42,80	K5	
	 Filter set for EVO 3 & EVO 4 ISO Coarse / ISO ePM1 (G4 / F7) 2 pieces <i>FIL-SET-EVO3/4-1CRS/1ePM1</i>	-	-	471 100 067	47,05	K5	

Replacement filters for ventilation units, filter box							
Product	Description	PU 1	PU 2	Article no.	Gross price €	Discount group	
ComfoAir Q350 / 450 / 600 and ComfoAir E350							
		Filter set for ComfoAir Q350/450/600/E350, ISO Coarse (G4), 2 pieces <i>FIL-CAQ-CRS-2PC</i>	75	225	400 502 012	51,70	K5
		Pollen filter set for ComfoAir Q350/450/600/E350, ISO Coarse / ISO ePM1 (G4 / F7) 2 pieces <i>FIL-CAQ-ePM1 / CRS</i>	58	348	400 502 013	55,90	K5
		Filter set for ComfoAir Q350/450/600/E350, ISO Coarse / Active coal ePM10, 2 pieces <i>FIL-CAQ-1PC-AC-EPM10-1PC-CRS-PCK</i>	-	250	400 100 097	57,90	K5
		Filter set for ComfoAir Q350/450/600/E350, ISO Coarse (G4), 10 pieces <i>FIL-CAQ-CRS-10PC</i>	-	56	400 502 014	231,20	K5
		Pollen filter set for ComfoAir Q350/450/600/E350, ISO ePM1 (F7) 10 pieces <i>FIL-CAQ-ePM1-10PC</i>	-	42	400 502 015	270,80	K5
		30 sets of filters Coarse/ G4 + ePM1/ F7 in 1 box suitable for ComfoAir Q and ComfoAir E, box consists of 60 filters with manual <i>FIL-CAQ-SET-CRS/CRS-PBG-30PCS</i>	1	-	400 100 118	1.088,20	K5
Iso filter box DN 125							
		Filter for iso filter box DN 125, ISO Coarse (M5), 1 piece <i>FIL-CLI200-FB-EPP-DN125-CRS/M5-1PC-PCK</i>	-	-	521 013 080	25,30	K5
		Pollen filter for iso filter box DN 125, ISO ePM1 (F7), 1 piece <i>FIL-CLI200-FB-EPP-DN125-ePM1/F7-1PC-PCK</i>	14	280	521 012 720	28,70	K5
		Active carbon filter for iso filter box DN 125, type AK, 1 piece <i>FIL-FB-EPP-DN125-AC-1PC</i>	-	-	521 014 090	50,30	K5

Replacement filters for heating elements, brine-earth heat exchangers, air distribution								
Product	Description	PU 1	PU 2	Article no.	Gross price €	Discount group		
Iso defroster box DN 160								
		Filter for iso defroster DN 160, ISO Coarse (G3) 1 piece <i>FIL-FB-PRH-EPP-DN160-CRS/G3-1PC</i>		7	140	524 000 810	25,80	K5
ComfoFond-L Q								
		Filter for ComfoFond-L Q, ISO Coarse (G4) 1 piece suitable for ComfoFond-L Eco 471310013, 471310018, 471310023, 471310028 and ComfoFond-L Q <i>FIL-CRS-SPR-P</i>		50	100	400 100 066	28,70	K5
Air distribution								
		Filter set DN 100, ISO Coarse (G3) suitable for Luna E125, extract valves and designer grills 10 pieces <i>FIL-DIV-DN100-CRS-10PC</i>		20	400	990 320 031	30,00	K5
		Filter set DN 125, ISO Coarse (G3) suitable for extract air valves and designer grilles CLRf / TVA 10 pieces <i>FIL-DIV-DN125-CRS-10PC</i>		122	366	990 320 032	33,10	K5

Notes

Grid area for notes.

always the best climate

Zehnder Baltics OÜ

Rannamõisa tee 38d ■ 13516 Tallinn ■ Estonia

+372 6840 937 ■ info.baltics@zehndergroup.com ■ www.zehnder.ee ■ www.zehnder.lv ■ www.zehnder.it