



# Design radiators for bathrooms

Prices and Technology 2026 - Zehnder Baltics OÜ

always the best climate



**Important notice:**  
5.5% price increase applies to all items in this price list from 08.06.2026.



Zehnder Studio Collection

studio collection



# always the best climate

Our mission is to provide a healthy indoor climate with top quality solutions. Living spaces are kept at a comfortable temperature by our radiators and heating & cooling ceilings whereas our ventilation solutions make sure that you can breathe fresh clean air 24/7.

**zehnder**

- Decorative radiators ■ Comfortable indoor ventilation
- Heating and cooling ceilings ■ Industrial air cleaning



global presence in over 70 countries

## Your global partner for indoor climate

### Trusted partner

We provide our customers with tailored services from planning to installation of excellent solutions for the best indoor climate since 1895.



### Know what's next

Consistent focus on innovation has always been the motor for our business. We strive to provide intelligent solutions for ventilation, heating, and cooling.



### Swiss quality and precision

Swiss quality and precision are reflected in all our products. Our design standards create timeless elegance in living spaces for yesterday, today, and tomorrow.



### Know why, know how

It is our ongoing mission to share our expertise and know how with our customers by providing expert trainings. Our dedicated Zehnder academies bring indoor climate to life.





Here for you,  
for over 125 years

## 125 years of Commitment

Over 125 years ago, Zehnder began with a simple dream: to create a company that offers excellent products and sustainable solutions to enhance lives. Today, this vision remains as strong as ever as we continue to address indoor climate challenges and improve quality of life. From the start, Zehnder understood the importance of being close to customers: listening, understanding and delivering value.

Our 'Here for you' philosophy guides us in growing and innovating through respectful dialogue and collaboration. Deeply rooted in European values, Zehnder is more than a company; it is a community built on trust and long-term partnerships with local presence.

We are proud to be part of this legacy, where our commitment to customer needs and local markets drives us to deliver tailored solutions. With the Zehnder family's leadership team ensuring continuity, you can rely on us for long-term support and collaboration.

Let us shape the future together.  
**Zehnder. Here for you!**



**zehnder**

” *I am proud to represent the younger generation on the Board of Directors.*

Milva Inderbitzin-Zehnder



EE



LV



LT

# Zehnder World of Colours

## Unique color worlds for bathrooms and living rooms

From our choice of clothing to our living environment. Colours allow customers to create their ideal individual style & space. Zehnder has recognised and responded to these new expectations and demands. The new Zehnder colour system gives your customers every option to perfectly coordinate the colour of their radiators with the latest interior design trends, seamlessly integrating them into any environment. From our choice of clothing to our living environment. Colours allow customers to create their ideal individual style & space.

Zehnder has recognised and responded to these new expectations and demands. The new Zehnder colour system gives your customers every option to perfectly coordinate the colour of their radiators with the latest interior design trends, seamlessly integrating them into any environment. The future of colours and aligning with today and tomorrow's trends is important to Zehnder, that's why the expertise of renowned colour trend experts was drawn on during the concept development. Long-term trends in six areas: architecture, interior design, bathrooms, living spaces, surfaces and materials were analysed and integrated into the concept, culminating in a future-oriented colour palette. Five modern Zehnder colour worlds were derived from these colour and living trends to ensure that the system always remains up to date and that the balance between fashions and long-term trends is maintained.

### The Sanctuary

The home as a place of rest, relaxation and retreat

The home is a place of relaxation and tranquillity. Rough surfaces, brushed finishes, mixed glazes and natural materials create sanctuaries. Natural off-white, light brown and grey tones are the key to a cosy environment to relax in. Brushed metals such as brass mixed with wood create a modern contrast. Round shapes and soft textures soften any feeling of austerity.



### The Mystical Home

A private place for personal rituals and wellness

Rough, natural surfaces contrast with refined designs. Rough concrete textures mixed with polished stone surfaces create a multi-sensory experience. Black and dark grey shades, graphite and taupe are the key to a mystical home. The monochrome rooms are accentuated by dark blue tones and brushed metal. The muted colour palette is made for a tranquil space for personal rituals and wellness.



# Neo Green

## Reflections on our desire for a natural environment

Green tones create a balance with our desire for more nature in our lives. Walls and floors, but also textiles and décor appear in shades of green. Soft, delicate mint or petrol-coloured graphite reflect our desire for a natural environment. Nude, light brown and grey tones create harmony and calm.



# Mother Earth

## Terracotta as a symbol for a warm and earthy look

Terracotta helps create an earthy and warm look, both as a material and as a colour. The highly pigmented quality of terracotta and the deeply saturated yet sun-faded solid colours create a natural and sophisticated look. Shades of cotton white, ochre, brick red and brown are combined to create an earthy colour palette. Terracotta is symbolic of the earth we live on and our strong desire to protect it.



# Mono Material Concrete

## The continuity of space – rough, seamless, expressive

The use of a single material creates a seamless, uniform look and a quiet space – free of visual noise. Raw concrete flows from the interior to the exterior, giving continuity to the space. Eccentric orange and natural brown tones create a modern contrast. Home accessories in brushed metal are perfectly combined.





## Zehnder Design Line

# Coloured Valves

## Absolutely stunning: Valve sets in matching colors

Decorative radiators for bathrooms are now also available with colored valves – for perfect color coordination of the valve sets and the radiator.

Further proof of the color expertise from Zehnder: Zehnder is now offering its decorative radiators for bathrooms with optional matching valves in almost every color on the Zehnder color chart. Until now, our valves have been available in white, chrome and for select models in stainless steel. Help your customers beautify their bathrooms. Color-matched valves and radiators help harmonise the complete ensemble, significantly enhancing the look of any bathroom. This makes the cosy warmth even more appealing.

### Advantages:

- Harmonised look and feel of the valves as an integral part of the radiator
- Colored valves make the purchase of new radiators even more attractive
- Great aesthetics

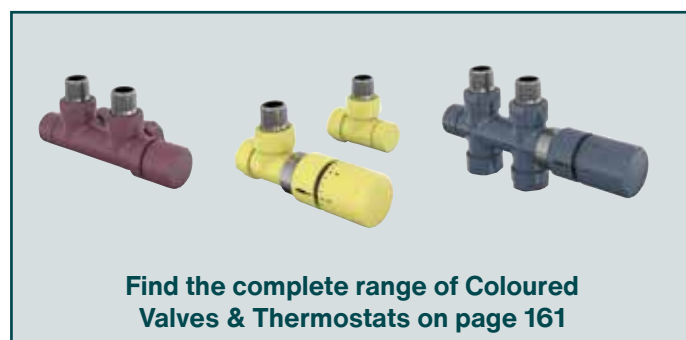



## Zehnder Studio Collection



	Zehnder Alban			ALZ..	8
	Zehnder Archibald			ABZ..	11
	Zehnder Arteplano			VZ..	16
	Zehnder Chime			CHZ..	21
	Zehnder Deseo Verso			DV..	25
	Zehnder Folio Belt			FZB..	28
	Zehnder Folio Glass			FZ..	32
	Zehnder Folio Hybrid			FZH..	35
	Zehnder Zenia			ZEN..	39
	Zehnder Tetris			TET..	45
	Zehnder Pera			PER..	49

## Premium Collection















	Zehnder Yucca Asym			YA..	54
	Zehnder Vitalo Bar			VIP..	60
	Zehnder Roda Twist Spa Air			ROE..	64
	Zehnder Metropolitan Spa			MET..	66
	Zehnder Metropolitan Bar			MEP..	70
	Zehnder Kazeane			RK..	75
	Zehnder Quaro			QA..	80
	Zehnder Subway			SUB..	86

## Quality Collection

	Zehnder Forma Asym			LFA..	94
	Zehnder Forma Spa			LF..	98
	Zehnder Fina Lean Bar			FIF..	104
	Zehnder Stalox			STX..	108
	Zehnder Toga			TG/TE..	110
	Zehnder Zeta			ZET..	115

### General Sales and Delivery Conditions:







Our General Sales and Delivery Conditions apply. You can find these on our homepage at [www.zehnder.ee/muugi-ja-tarnetingimused](http://www.zehnder.ee/muugi-ja-tarnetingimused)

<b>Bathroom Essentials</b>	 Zehnder Virando    AB.. <b>119</b>
	 Zehnder Virando Bow   ABT.. <b>123</b>
	 Zehnder Aura    PBN.. <b>127</b>
	 Zehnder Aura Bow    PBTN.. <b>132</b>
<b>Accessories and general information</b>	Retrofit solutions <b>136</b>
	Room dividers <b>137</b>
	Mounting sets & accessories <b>138</b>
	<b>New electric platform &amp; retrofit immersion heaters</b> <b>NEW 146</b>
	Thermostats & Valves <b>158</b>
	Coloured Thermostats and Valves <b>161</b>
	Conversion factors <b>164</b>
	Keyword list <b>165</b>
	Zehnder Colour Chart <b>174</b>
<b>How about an comfortable indoor ventilation?</b> Zehnder comfortable indoor ventilation <b>172</b>	

## How to order models with Zehnder new electric platform:

YAZCR130040E ZD

The blank space in the model code represents the heating element. Simply replace it with:  
**C for IHC**  
**A for IHE**

-  Operation on central heating system
-  Dual energy operation with integrated electric heating element; hot water models can be converted to dual energy operation on site\*
-  Dual energy operation possible on site\*
-  Hybrid: dual energy operation for hot water central heating system and electric operation
-  Electric operation\*
-  Electric operation on request
-  New electronic platform

\* Additional information about the versions with electric operation and dual energy operation is available on the respective product pages.

studio  
collection

## Zehnder Alban

A design concept made for purists – precise lines, flat sides and right angles. The angular radiator with a practical side – slide on and hang up towels effortlessly with just one hand. Connected directly to the central heating system, this decorative radiator keeps the bathroom warm and comfortable. Alban from the Zehnder Studio Collection: the design version made of hand-polished, high-quality stainless steel. Simple, elegant design – and warm towels whenever you need them.



Radiator surface: Hand-polished stainless steel



## Zehnder Alban



Radiator surface: Hand-polished stainless steel



### Operation on central heating system

The Zehnder Alban decorative radiator from the Studio Collection is a designer piece made of hand-polished, high-quality stainless steel with horizontally arranged square pipes and vertical header tubes.

Bath towels can be effortlessly inserted at the side and hung up with just one hand. Square tubes 50 x 30 mm, header tubes 30 x 30 mm. Thermal outputs to EN 442, with CE marking.

4 x 1/2" female thread on the ends of the header tubes. Option to choose installation as right-hand or left-hand version (flow/return at the bottom with left or right options), distance 50 mm; 2 x 1/2" directional air vent at top, screwed in at the factory for installation as right-hand version. Delivered ready to install with elegant wall brackets in chrome.

Operating pressure	max. 5.2 bar
Operating temperature	max. 90 °C
Height	..... mm
Length	..... mm
Model	.....

### Advantages

- Hand-polished stainless steel surface for an exclusive look
- Ideal for hanging up towels thanks to large tube spacing
- Can be installed as a right-handed or left-handed version
- High-quality stainless steel surface ensures easy cleaning and maximum hygiene

### Standard scope of delivery for operation on central heating system

- Hand-polished stainless steel
- 4 x 1/2" connections for flow, return, vent
- 2 x directional air vent 1/2" screwed in at the factory for installation as right-hand version
- Elegant wall brackets in chrome
- Packaging

## Overview of models

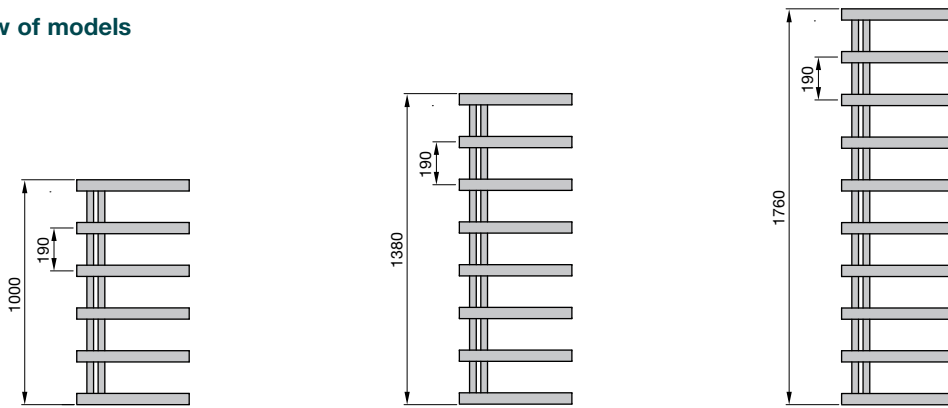

## Connection to hot water central heating system

Model	H mm	L mm	Thermal output			Exp. n	Classification Electric heating element Watt	V dm <sup>3</sup>	M kg	Price Stainless steel €	
			EN 442 <sup>Ⓢ</sup> W	70/55/24 W	55/45/24 W						55/45/20 W
<b>Stainless steel version</b>											
ALZ-100-050	1000	500	256	182	112	134	1.25	-	5.5	6.6	1.167,30
ALZ-140-050	1380	500	332	233	140	170	1.30	-	7.4	8.7	1.412,28
ALZ-180-050	1760	500	417	298	183	220	1.24	-	9.3	10.8	1.700,51

Special solution on request (surcharge)	Article no.	Price €
▪ Zehnder thermostat	-	see page 158
▪ Zehnder valves, return screw connections and fittings	-	see page 159 onwards

## Operation on central heating system:

Wall mounting, installation as right-hand version

Wall mounting, installation as left-hand version

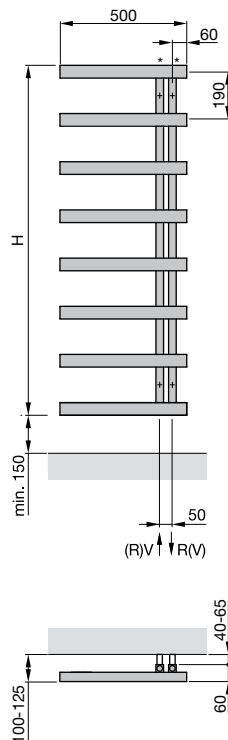
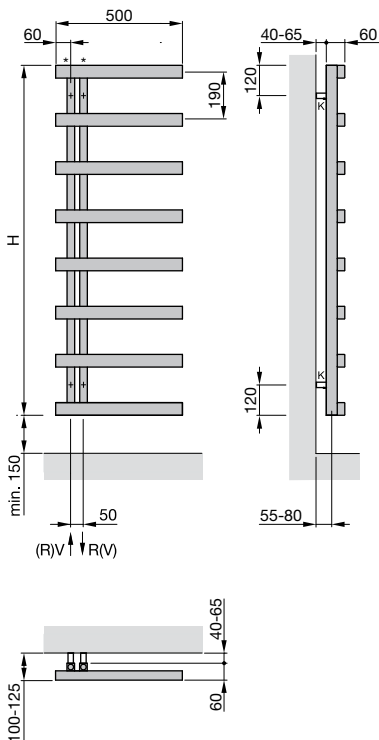

- H = Height
- V = Flow
- R = Return
- K = Bracket(s)
- \* = Vent

Dimensions in mm

Ⓢ Thermal output to EN 442, ΔT 50 K (75/65/20 °C)

studio  
collection

## Zehnder Archibald

Always at your service. This unique designer radiator is elegant yet highly functional. Archibald from the Zehnder Studio Collection is the perfect practical bathroom accessory, warming and drying your towels and creating a pleasant, comfortable climate. Seamlessly formed from a single curved steel tube, the shape is as striking as the construction is unique. With Zehnder Archibald, designer Leo Salzedo has created a stylish and contemporary room feature that combines functionality with distinctive design.



Radiator surface: Chrome

# Zehnder Archibald



Radiator surface: Chrome

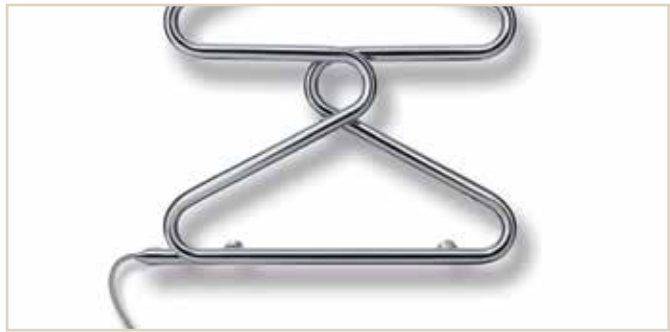
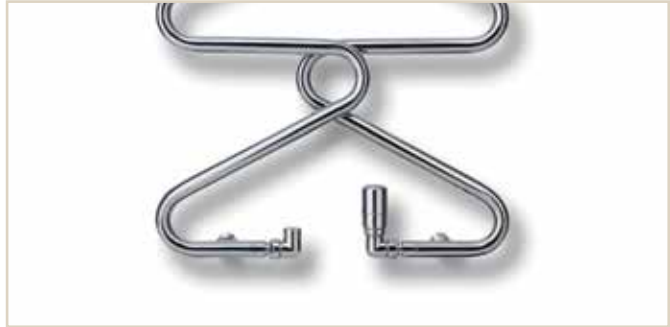

### Operation on central heating system

Seamlessly formed from a single curved steel tube, the shape is as striking as the construction is unique. Zehnder Archibald from the Studio Collection creates a stylish and contemporary room feature that combines functionality with distinctive design. Its space-saving design can hold up to four towels, which can be heated simultaneously. Round tubes Ø 25 mm made of steel. Thermal outputs to EN 442, with CE marking. Standard 2 x 1/2" with female thread, flow/return installed with left-hand or right-hand option, at the bottom horizontal facing inwards, 1/4" vent at the top facing the rear. Ideal with valve unit and return screw connection in an angle-angle design. Radiator with powder coating, in the colour RAL 9016 as standard, in a special colour or in chrome on request. Delivered ready to install with matching wall brackets in colour of radiator.

Operating pressure	max. 12.0 bar
Operating temperature	max. 110 °C
Height	..... mm
Length	..... mm
Model	.....

### Advantages

- Innovative design
- Seamlessly finished with curved steel
- Ideal for hanging up towels
- Space-saving design

### Electric operation

Seamlessly formed from a single curved steel tube, the shape is as striking as the construction is unique. Zehnder Archibald creates a stylish and contemporary room feature that combines high functionality with distinctive design. Its space-saving design can hold up to four towels, which can be heated simultaneously. Round tubes Ø 25 mm made of steel. With integrated heating element IHE, degree of protection IP65, filled with heat transfer fluid. With connection cable 1.2 m in length with two pin plug. White cable, plug and cable cover; chrome radiators have a grey cable and plug with a chrome cable cover. Decorative radiator filled with heat transfer fluid. The electric heating element does not have any operating options. The control has to be planned and executed on site. Radiator with powder coating, in colour RAL 9016 as standard, in special colour or chrome on request. Delivered ready to install with matching wall brackets in colour of radiator.

Output	..... W
Height	..... mm
Length	..... mm
Model	.....



## Zehnder Archibald

### Overview of models

Operation on central heating system    Electric operation

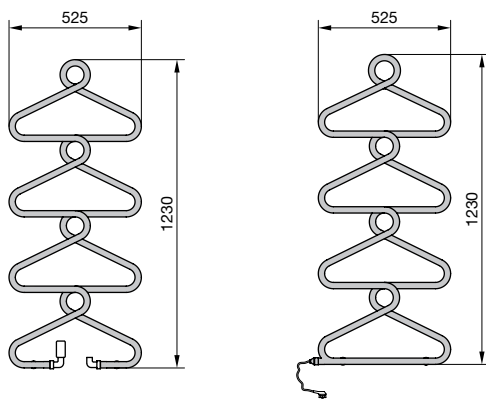

### Connection to hot water central heating system

Model	H mm	L mm	Thermal output				Exp. n	Classification Electric heating element Watt	V dm <sup>3</sup>	M kg	Price RAL 9016 €	Price <sup>①</sup> Cat. 1 €
			EN 442 <sup>②</sup> W	70/55/24 W	55/45/24 W	55/45/20 W						

#### Painted version

<b>ABZ-120-50</b>	1230	525	336	241	150	179	1.22	-	2.3	4.6	<b>1.245,35</b>	<b>1.556,68</b>
-------------------	------	-----	-----	-----	-----	-----	------	---	-----	-----	-----------------	-----------------

Model	H mm	L mm	Thermal output				Exp. n	Classification Electric heating element Watt	V dm <sup>3</sup>	M kg	Price Chrome €
			EN 442 <sup>②</sup> W	70/55/24 W	55/45/24 W	55/45/20 W					

#### Chrome-plated version

<b>ABZC-120-50</b>	1230	525	233	166	102	122	1.25	-	2.3	4.6	<b>1.731,75</b>
--------------------	------	-----	-----	-----	-----	-----	------	---	-----	-----	-----------------

① For special colours in categories 1 and 2, see special solutions and colour chart

② Thermal output to EN 442,  $\Delta T$  50 K (75/65/20 °C)

## Zehnder Archibald

### Electric-only operation with IHE



Model	H mm	L mm	Classification Electric heating element Watt	Price RAL 9016 €	Price ① Cat. 1 €
-------	---------	---------	--	------------------------	------------------------

#### Painted version

ARBSS120050EAZD	1230	525	200	1.462,25	1.804,72
-----------------	------	-----	-----	----------	----------

Model	H mm	L mm	Classification Electric heating element Watt	Price Chrome €
-------	---------	---------	--	----------------------

#### Chrome-plated version

ARBCS120050EAZD	1230	525	200	1.997,29
-----------------	------	-----	-----	----------

#### Standard scope of delivery for operation on central heating system

- Powder coating to DIN 55900, RAL 9016
- 2 x ½" connections for flow, return
- 1 x ¼" vent
- Elegant wall brackets in radiator colour
- Packaging

#### Standard scope of delivery for electric operation

- Powder coating to DIN 55900, RAL 9016
- Built-in heating element IHE, control unit integrated into the design (for white radiator) or chrome (all other surfaces). Filled with non-flammable heat-transfer fluid (frost-proof to -10°C)
- Mounting accessories in colour of radiator
- Packaging

Special solution on request (surcharge)	Article no.	Price €
▪ Special finish to category 2 (surcharge on cat. 1)	-	146,76
▪ Zehnder thermostat	-	see page 158
▪ Zehnder valves, return screw connections in an angle-angle design	-	see page 159 onwards

① For special colours in categories 1 and 2, see special solutions and colour chart  
For keywords, see 'Electric operation and Ecodesign Directive' on page 166 [f](#)



# Zehnder Archibald

## Operation on central heating system:

Wall mounting

Back cover

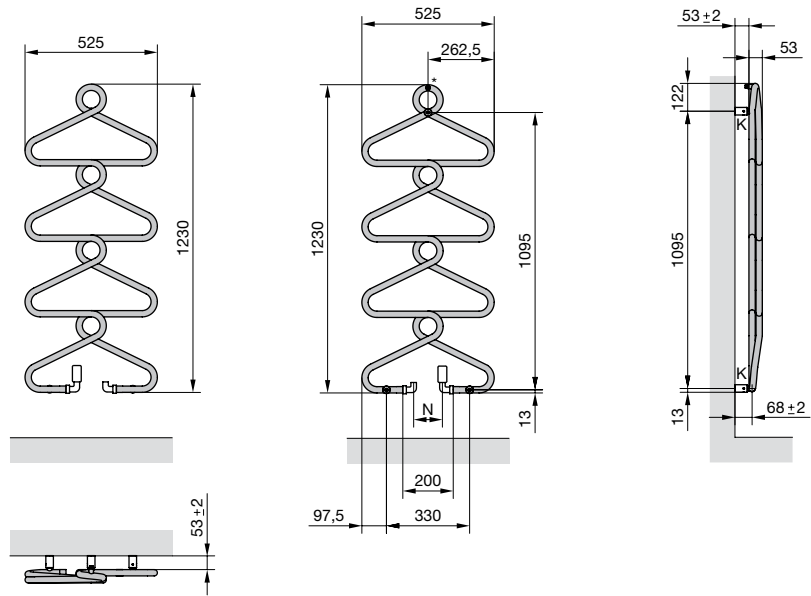

## Electric operation:

Wall mounting

Back cover

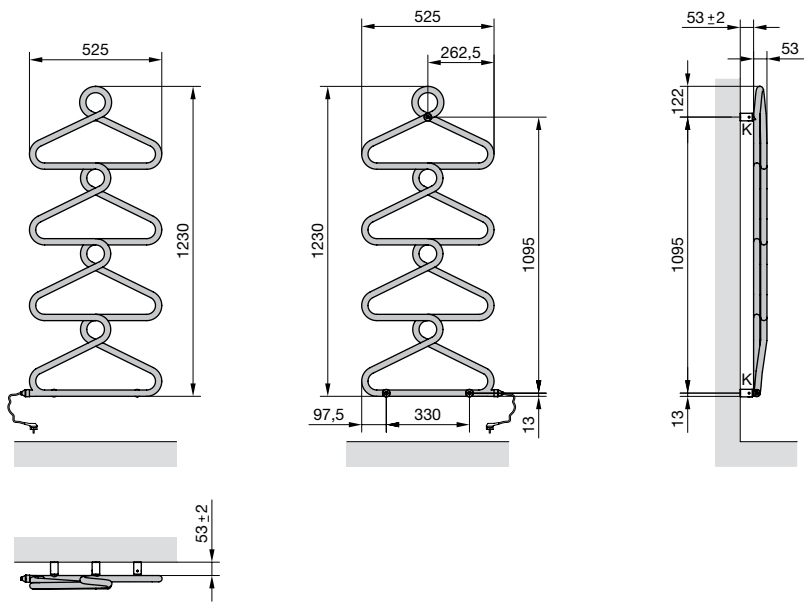

- K = Bracket(s)
- N = Connection size depends on the valve or return screw connection
- \* = Vent

Dimensions in mm

studio  
collection

## Zehnder Arteplano

Pure and simple. This designer radiator celebrates the perfection of material and finish, combining state-of-the-art heating technology with striking contemporary design. The smooth surfaces efficiently give out a pleasing warmth whilst subtly integrating the radiator into the room. Alternatively, it can be transformed into a feature in its own right with the wide selection of materials and finishes. The only limit is your imagination. Arteplano from the Zehnder Studio Collection. The art of making a statement.



Radiator surface: Stainless steel



# Zehnder Arteplano



Radiator surface: Stained copper



Radiator surface: Stainless steel, mirror polished

### Operation on central heating system

Zehnder Arteplano from the Studio Collection is impressive with its smooth surface, creating a cosy warmth in no time with its exceptional responsiveness. With such a wide range of materials and finishes to choose from, the decorative radiator integrates harmoniously into any room.

Flat front, thermo-lacquered steel as standard. With optional towel rail for retrofitting at any height. Several towel rails possible for each radiator. Side covers permanently welded to the radiator and not removable (model ZVZA and ZVZLA included in standard scope of delivery). Thermal output to EN 442, with CE marking. With the factory standard connections with 4 x 1/2" female thread, the following connection types are possible. 1/2" flow/return at bottom vertical opposite end, installed with left, right or centre option 50 mm, with 1/2" directional air vent at top right.

Radiator with powder coating, in colour RAL 9016 as standard, in special colour or surface. Delivered ready to install with wall brackets.

Operating pressure	max. 4.6 bar
Operating temperature	max. 80 °C
Height	..... mm
Length	..... mm
Model	.....

### Advantages

- Sleek design
- Several exclusive surfaces to choose from
- Variety of models suitable for a wide range of local conditions
- Quick responsiveness
- High-quality decorative panel radiator

## Zehnder Arteplano

### Overview of models

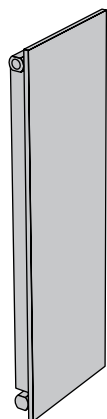

ZVZA

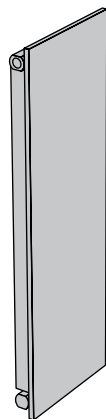

ZVZLA

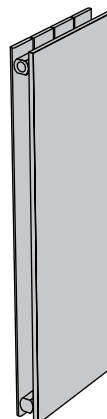

ZVZAD

### Connection to hot water central heating system

Model	H mm	L mm	Thermal output				Exp. n	Classification Electric heating element Watt	V dm <sup>3</sup>	M kg	Price RAL 9016 €	Price <sup>Ⓞ</sup> Cat. 1 €
			EN 442 <sup>Ⓞ</sup> W	70/55/24 W	55/45/24 W	55/45/20 W						

#### Single-layer version, painted version

<b>ZVZA160-4</b>	1613	305	461	324	195	235	1.30	-	2.6	20.4	<b>1.007,45</b>	<b>1.259,31</b>
<b>ZVZA180-4</b>	1813	305	517	364	218	264	1.30	-	2.9	22.8	<b>1.085,93</b>	<b>1.357,40</b>
<b>ZVZA200-4</b>	2013	305	574	404	242	293	1.30	-	3.1	25.1	<b>1.158,69</b>	<b>1.448,35</b>
<b>ZVZA160-6</b>	1613	453	695	489	294	355	1.30	-	3.9	30.6	<b>1.255,72</b>	<b>1.569,65</b>
<b>ZVZA180-6</b>	1813	453	780	549	329	398	1.30	-	4.3	34.1	<b>1.339,90</b>	<b>1.674,88</b>
<b>ZVZA200-6</b>	2013	453	865	608	365	442	1.30	-	4.7	37.7	<b>1.452,65</b>	<b>1.815,81</b>
<b>ZVZA160-7</b>	1613	527	812	571	343	415	1.30	-	4.6	35.7	<b>1.379,89</b>	<b>1.724,86</b>
<b>ZVZA180-7</b>	1813	527	911	641	385	465	1.30	-	5.0	39.8	<b>1.466,93</b>	<b>1.833,67</b>
<b>ZVZA200-7</b>	2013	527	1010	710	427	516	1.30	-	5.5	44.0	<b>1.599,62</b>	<b>1.999,54</b>
<b>ZVZA160-8</b>	1613	601	929	653	392	475	1.30	-	5.2	40.8	<b>1.504,00</b>	<b>1.880,01</b>
<b>ZVZA180-8</b>	1813	601	1042	733	440	532	1.30	-	5.8	45.5	<b>1.593,90</b>	<b>1.992,39</b>
<b>ZVZA200-8</b>	2013	601	1155	812	488	590	1.30	-	6.2	50.2	<b>1.746,59</b>	<b>2.183,25</b>
<b>ZVZA160-10</b>	1613	749	1163	818	491	594	1.30	-	6.5	51.0	<b>1.752,31</b>	<b>2.190,39</b>
<b>ZVZA180-10</b>	1813	749	1304	917	551	666	1.30	-	7.2	56.9	<b>1.847,91</b>	<b>2.309,90</b>
<b>ZVZA200-10</b>	2013	749	1446	1017	611	739	1.30	-	7.8	62.8	<b>2.040,56</b>	<b>2.550,71</b>

Model	H mm	L mm	Thermal output				Exp. n	Classification Electric heating element Watt	V dm <sup>3</sup>	M kg	Price RAL 9016 €	Price <sup>Ⓞ</sup> Cat. 1 €
			EN 442 <sup>Ⓞ</sup> W	70/55/24 W	55/45/24 W	55/45/20 W						

#### Single-layer version with fins, painted version

<b>ZVZLA160-4</b>	1613	305	616	431	257	311	1.32	-	2.6	25.6	<b>1.469,79</b>	<b>1.837,23</b>
<b>ZVZLA180-4</b>	1813	305	693	486	291	352	1.31	-	2.9	29.6	<b>1.582,51</b>	<b>1.978,13</b>
<b>ZVZLA200-4</b>	2013	305	743	521	312	378	1.31	-	3.1	32.1	<b>1.699,50</b>	<b>2.124,38</b>
<b>ZVZLA160-6</b>	1613	453	928	649	387	469	1.32	-	3.9	38.5	<b>1.743,75</b>	<b>2.179,69</b>
<b>ZVZLA180-6</b>	1813	453	1044	732	438	530	1.31	-	4.3	44.5	<b>1.879,30</b>	<b>2.349,12</b>
<b>ZVZLA200-6</b>	2013	453	1119	785	469	569	1.31	-	4.7	48.1	<b>2.022,00</b>	<b>2.527,50</b>
<b>ZVZLA160-7</b>	1613	527	1084	758	452	548	1.32	-	4.6	44.9	<b>1.880,73</b>	<b>2.350,90</b>
<b>ZVZLA180-7</b>	1813	527	1219	855	511	619	1.31	-	5.0	51.9	<b>2.027,72</b>	<b>2.534,64</b>
<b>ZVZLA200-7</b>	2013	527	1308	917	549	665	1.31	-	5.5	56.1	<b>2.183,25</b>	<b>2.729,07</b>
<b>ZVZLA160-8</b>	1613	601	1240	867	517	627	1.32	-	5.2	51.3	<b>2.017,72</b>	<b>2.522,15</b>
<b>ZVZLA180-8</b>	1813	601	1395	978	585	709	1.31	-	5.8	59.3	<b>2.176,12</b>	<b>2.720,15</b>
<b>ZVZLA200-8</b>	2013	601	1496	1049	628	760	1.31	-	6.2	64.2	<b>2.344,51</b>	<b>2.930,64</b>
<b>ZVZLA160-10</b>	1613	749	1552	1086	647	785	1.32	-	6.5	64.1	<b>2.291,71</b>	<b>2.864,63</b>
<b>ZVZLA180-10</b>	1813	749	1746	1225	733	887	1.31	-	7.2	74.1	<b>2.472,92</b>	<b>3.091,14</b>
<b>ZVZLA200-10</b>	2013	749	1872	1313	785	951	1.31	-	7.8	80.2	<b>2.666,99</b>	<b>3.333,75</b>



## Zehnder Arteplano

### Connection to hot water central heating system

Model	H mm	L mm	Thermal output				Exp. n	Classification Electric heating element Watt	V dm <sup>3</sup>	M kg	Price RAL 9016 €	Price <sup>①</sup> Cat. 1 €
			EN 442 <sup>②</sup> W	70/55/24 W	55/45/24 W	55/45/20 W						
<b>Double-layer version, painted version</b>												
ZVZAD160-4	1613	305	680	476	283	344	1.32	-	4.8	31.1	1.648,14	2.060,18
ZVZAD180-4	1813	305	757	531	318	385	1.31	-	5.3	34.8	1.779,42	2.224,28
ZVZAD200-4	2013	305	833	584	349	423	1.31	-	5.8	38.5	1.907,84	2.384,80
ZVZAD160-6	1613	453	1025	717	427	518	1.32	-	7.1	46.7	2.121,90	2.652,37
ZVZAD180-6	1813	453	1141	800	479	580	1.31	-	7.9	52.3	2.295,99	2.869,99
ZVZAD200-6	2013	453	1255	880	527	638	1.31	-	8.8	57.7	2.467,22	3.084,04
ZVZAD160-7	1613	527	1197	837	499	605	1.32	-	8.3	54.5	2.358,74	2.948,43
ZVZAD180-7	1813	527	1333	935	559	677	1.31	-	9.2	61.0	2.554,25	3.192,83
ZVZAD200-7	2013	527	1466	1028	615	745	1.31	-	10.2	67.3	2.746,91	3.433,64
ZVZAD160-8	1613	601	1370	958	571	693	1.32	-	9.5	62.2	2.595,65	3.244,56
ZVZAD180-8	1813	601	1524	1069	639	774	1.31	-	10.6	69.7	2.812,54	3.515,68
ZVZAD200-8	2013	601	1677	1176	704	852	1.31	-	11.7	77.0	3.026,59	3.783,24
ZVZAD160-10	1613	749	1714	1199	714	866	1.32	-	11.9	77.8	3.069,38	3.836,73
ZVZAD180-10	1813	749	1908	1338	800	970	1.31	-	13.2	87.1	3.329,10	4.161,38
ZVZAD200-10	2013	749	2099	1472	881	1067	1.31	-	14.6	96.2	3.585,95	4.482,44

### Standard scope of delivery for operation on central heating system

- Powder coating to DIN 55900, RAL 9016
- 4 x ½" connections for flow, return at bottom, vertical opposite end, left, right or centre option 50 mm
- 1 x ½" vent, top right
- Wall brackets in radiator colour:  
Model ZVZA: CVD2, model ZVZLA: CVD1, model ZVZAD: CVD0
- Packaging

Special solution on request (surcharge)	Article no.	Price €
▪ Special finish to category 2 (surcharge on cat. 1)	-	150,43
▪ ZVZAD model: Side covers firmly welded to the radiator and not removable <sup>③</sup>	-	115,26
▪ ZVZAD model: Side covers for retrofitting in white RAL 9016 <sup>③</sup>	128161	254,53
▪ ZVZAD model: Side covers for retrofitting in special finish <sup>③</sup>	128169	317,66
▪ Stainless steel towel rail, polished	-	see page 145

### Exclusive surfaces

Refined front	Code	Basic radiators	Surcharge <sup>④</sup> €
Stainless steel, mirror polished <sup>④</sup>	9516	RAL 9007	1.348,05
Stained copper	9523	RAL 8003	1.348,05
Stained brass	9521	0337 Antique gold met.	1.348,05



Stainless steel,  
mirror polished  
(code 9516)



Stained copper  
(code 9523)

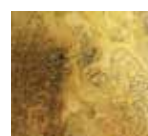

Stained brass  
(code 9521)

① For special colours in categories 1 and 2, see special solutions and colour chart

② Thermal output to EN 442, ΔT 50 K (75/65/20 °C)

③ Reduced output 6%

④ Surface stainless steel 9% reduced output

⑤ Surcharge on price cat. 1

Please note the information on surfaces in the keyword list under 'Special finishes/surfaces'

# Zehnder Arteplano

**Operation on central heating system:**  
Wall mounting, ZVZA model

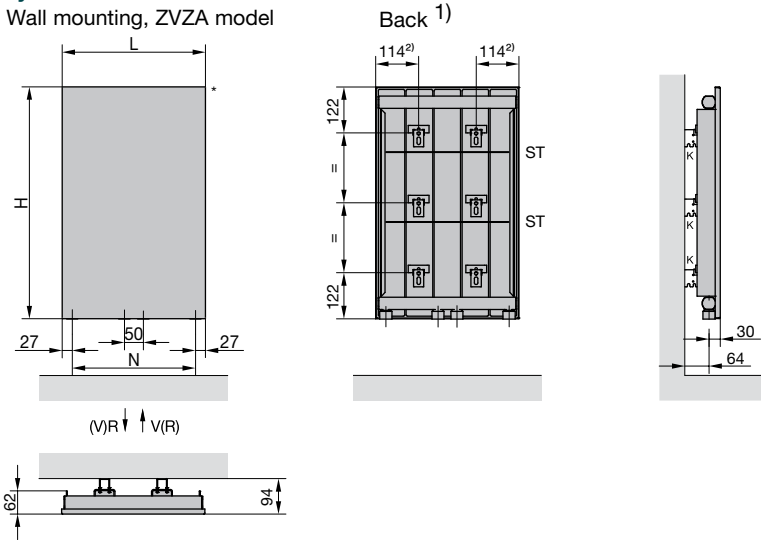

**Operation on central heating system:**  
Wall mounting, ZVZLA model

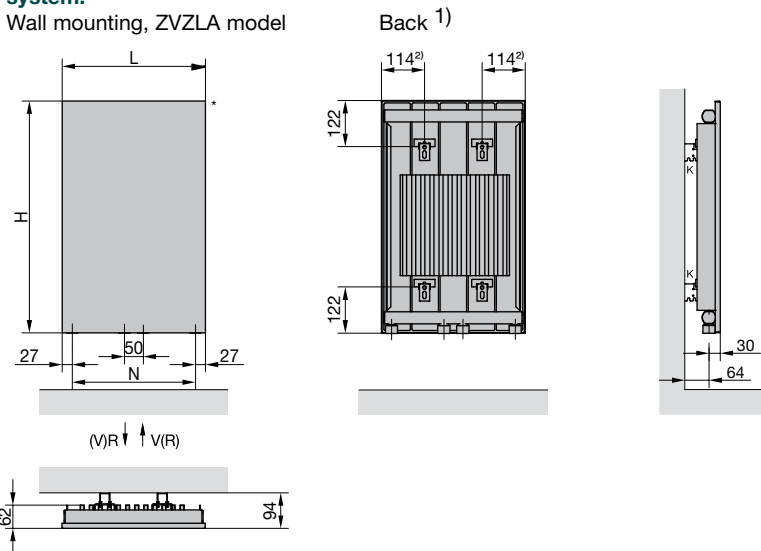

**Operation on central heating system:**  
Wall mounting, ZVZAD model

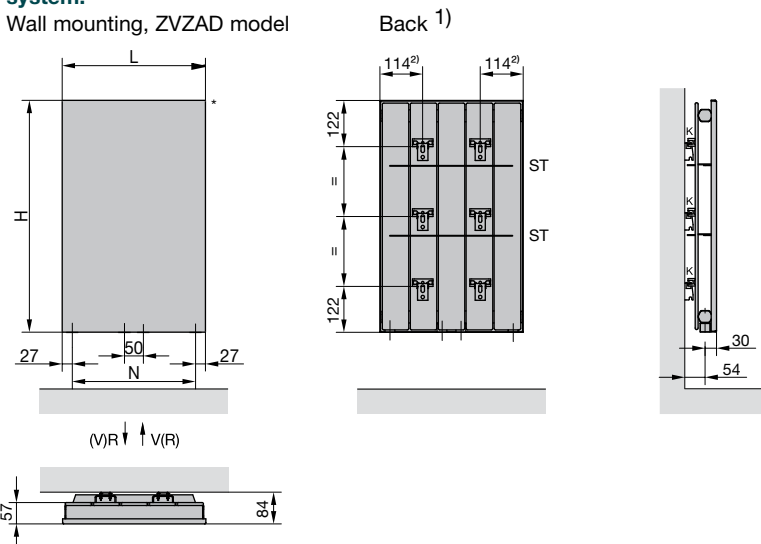

- H = Height
- L = Length
- N = Connection centre
- ST = Stabilising brace
- K = Bracket(s)
- \* = Vent

Dimensions in mm

- 1) Dimensional tolerances of the fixing points  $\pm 5$  mm
- 2) 77 mm for length L = 305 mm

studio  
collection

## Zehnder Chime

The athlete of the radiator world – striking, self-assured design consisting of elegantly curved round tubes whose open side allows even very thick towels to be slid on as a convenient way of drying or warming them. Chime from the Zehnder Studio Collection: the round design version made of hand-polished, high-quality stainless steel; can be installed with the open end on the left or right. Zehnder Chime makes a bold statement in your bathroom – and has the added bonus of giving you beautifully pre-warmed towels.



Radiator surface: Hand-polished stainless steel

## Zehnder Chime

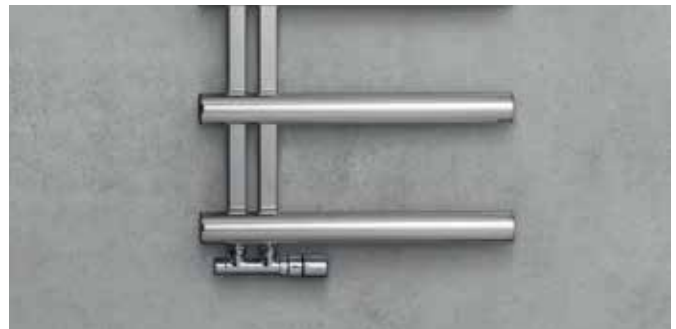

Radiator surface: Hand-polished stainless steel

### Operation on central heating system

Zehnder Chime from the Studio Collection: the round design version made of hand-polished, high-quality stainless steel can be installed with the open end on the left or right. Powerful, self-assured design consisting of elegantly curved round tubes whose open side allows even very thick towels to be slid on as a convenient way of warming them.

Horizontal tubes each branch asymmetrically from the laterally arranged manifolds. Round tube Ø 51 mm, header tube 30 x 30 mm. Thermal output tested to EN 442, with CE marking. 4 x ½" female thread on the header tubes, connection size 50 mm. Flow, return at bottom, left-hand or right-hand installation option; top 2 x ½" directional air vent, screwed in at the factory for installation as right-hand version. Delivered ready to install with elegant wall brackets in chrome.

Operating pressure	max. 5.2 bar
Operating temperature	max. 90 °C
Height	..... mm
Length	..... mm
Model	.....

### Advantages

- Hand-polished stainless steel
- Ideal for hanging towels due to large tube spacing and asymmetrical tube arrangement
- Can be installed as a right-handed or left-handed version
- Easy to clean

### Standard scope of delivery for operation on central heating system

- Hand-polished stainless steel
- 4 x ½" connections for flow, return, vent
- 2 x directional air vent ½" screwed in at the factory for installation as right-hand version
- Elegant wall brackets in chrome
- Packaging



## Zehnder Chime

### Overview of models

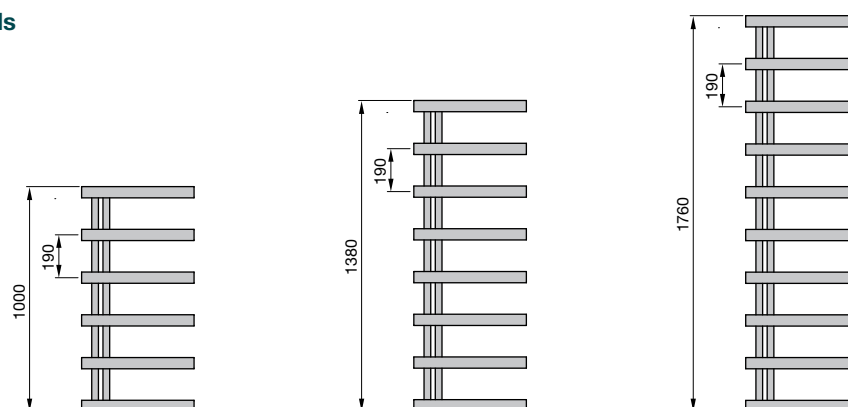

### Connection to hot water central heating system

Model	H mm	L mm	EN 442 W	Thermal output			Exp. n	Classification Electric heating element Watt	V dm <sup>3</sup>	M kg	Price €
				70/55/24 W	55/45/24 W	55/45/20 W					

#### Stainless steel polished, Mirror version

CHZ-100-050	1000	500	276	193	114	139	1.33	-	7.1	7.3	<b>1.167,30</b>
CHZ-140-050	1380	500	377	272	170	203	1.20	-	9.5	9.6	<b>1.412,28</b>
CHZ-180-050	1760	500	438	314	194	232	1.23	-	12.0	12.0	<b>1.700,51</b>

Model	H mm	L mm	EN 442 W	Thermal output			Exp. n	Classification Electric heating element Watt	V dm <sup>3</sup>	M kg	Price €
				70/55/24 W	55/45/24 W	55/45/20 W					

#### Stainless steel polished, Volcanic version

CHZ-100-50-0336	1000	500	276	193	114	139	1.33	-	7.1	7.3	<b>943,87</b>
CHZ-140-50-0336	1380	500	377	272	170	203	1.20	-	9.5	9.6	<b>1.185,32</b>
CHZ-180-50-0336	1760	500	438	314	194	232	1.23	-	12.0	12.0	<b>1.448,73</b>

Model	H mm	L mm	EN 442 W	Thermal output			Exp. n	Classification Electric heating element Watt	V dm <sup>3</sup>	M kg	Price Stainless steel €
				70/55/24 W	55/45/24 W	55/45/20 W					

#### Stainless steel Brushed version

CHZ-100-50-9517	1000	500	276	193	114	139	1.33	-	7.1	7.3	<b>826,80</b>
CHZ-140-50-9517	1380	500	377	272	170	203	1.20	-	9.5	9.6	<b>1.038,99</b>
CHZ-180-50-9517	1760	500	438	314	194	232	1.23	-	12.0	12.0	<b>1.229,22</b>

Model	H mm	L mm	EN 442 W	Thermal output			Exp. n	Classification Electric heating element Watt	V dm <sup>3</sup>	M kg	Price €
				70/55/24 W	55/45/24 W	55/45/20 W					

#### Brushed Brass version

CHZ-100-50-N209	1000	500	276	193	114	139	1.33	-	7.1	7.3	<b>1.167,30</b>
CHZ-140-50-N209	1380	500	377	272	170	203	1.20	-	9.5	9.6	<b>1.412,28</b>

Model	H mm	L mm	EN 442 W	Thermal output			Exp. n	Classification Electric heating element Watt	V dm <sup>3</sup>	M kg	Price €
				70/55/24 W	55/45/24 W	55/45/20 W					

#### Brushed Black Chrome version

CHZ-100-50-N211	1000	500	276	193	114	139	1.33	-	7.1	7.3	<b>1.167,30</b>
CHZ-140-50-N211	1380	500	377	272	170	203	1.20	-	9.5	9.6	<b>1.412,28</b>

# Zehnder Chime

## Connection to hot water central heating system

Model	H mm	L mm	Thermal output			Exp. n	Classification Electric heating element Watt	V dm <sup>3</sup>	M kg	Price €
			EN 442 <sup>①</sup> W	70/55/24 W	55/45/24 W					

### Brushed Bronze version

CHZ-100-50-N213	1000	500	276	193	114	139	1.33	-	7.1	7.3	1.167,30
CHZ-140-50-N213	1380	500	377	272	170	203	1.20	-	9.5	9.6	1.412,28

Special solution on request (surcharge)	Article no.	Price €
▪ Zehnder thermostat	-	see page 158
▪ Zehnder valves, return screw connections and fittings	-	see page 159 onwards

### Operation on central heating system:

Wall mounting, installation as right-hand version

Wall mounting, installation as left-hand version

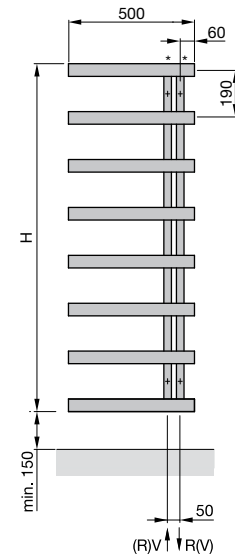
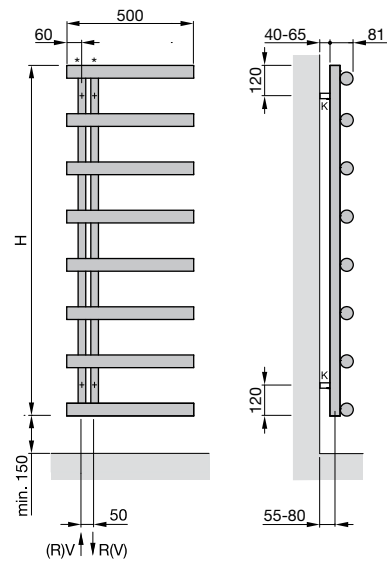

- H = Height
- V = Flow
- R = Return
- K = Bracket(s)
- \* = Vent

Dimensions in mm

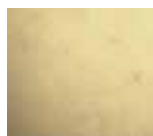
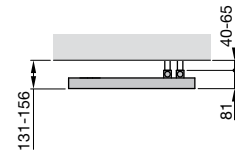
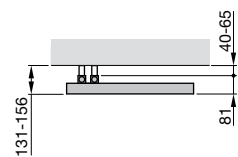

Brushed Brass  
(code N209)



Brushed Black  
Chrome  
(code N211)



Brushed Bronze  
(code N213)

① Thermal output to EN 442, ΔT 50 K (75/65/20 °C)

studio  
collection

## Zehnder Deseo Verso

The Zehnder Deseo Verso electric glass radiator from the Studio Collection combines a modern design with exceptional comfort and outstanding functionality. The elegant black, white or even reflective heated glass front makes this decorative radiator an eye-catching feature that fits perfectly into all kinds of bathroom designs. Additional special features for users: One or two extendable towel rails, depending on the model, which can be mounted on the back of the radiator. This allows the towels to 'disappear' behind the glass front and keeps the bathroom looking neat and tidy. Every detail perfectly thought out.



**DESIGN PLUS**  
powered by: **ISH**



Heated glass front: Black

## Zehnder Deseo Verso



Heated glass front: Black



Heated glass front: White

### Electric operation

Zehnder Deseo Verso decorative radiator, electric-only, made of safety glass – double-hardened (class B in accordance with EN 12600), includes one or two polished stainless steel towel rails (depending on model) for mounting on the back of the radiator at the specified height with extension to the right or left (can be selected for each towel rail when installing).

Operation of the heated glass front via simple control panel (modes: Surface temperature 45 °C, 55 °C, 65 °C, 2 h timer function, off), with keylock option, or using separate model 4 battery-powered infrared remote control model 4 with room temperature control (modes: frost protection, economy, comfort, individual daily or weekly programme, off).

Heated glass front available in black, white or as a mirror.

Connection cable 1,8 m long with two pin plug, simple cable routing adjusted to the towel rail installation via cable clips pre-installed on the back of the decorative radiator ex works. Nominal voltage 230 volts, splash-proof IP 45.

Output	..... W
Height	..... mm
Length	..... mm
Model	.....

### Advantages

- Minimalist, modern design that adds an elegant touch to the bathroom
- Practical: extendable towel rail on the back of the radiator ensures a tidy bathroom
- Heated glass front provides pleasant warmth in next to no time
- Convenient operation via control panel or remote control
- Supplied mounting template ensures easy installation
- Low energy consumption in stand-by mode ( $\leq 0.5$  W)
- Energy-efficient and comfortable heating via innovative open window detection
- Ready-to-plug

### Standard scope of delivery for electric operation

- Radiator made from safety glass with control box and cable clips pre-installed on the back
- Polished stainless steel towel rails for mounting on the back of the radiator, extension either to left or right (as selected during installation); for 1500 mm height: one towel rail; for 1750 mm height: two towel rails per radiator, with fixing material
- Infrared remote control model 4 including batteries (AAA) with selectable modes: manual (above room temperature), weekly programme, timer, frost protection, off
- Wall mounting accessories and cable clips in the colour of the radiator, or for mirror radiators: Wall bracket + cable clips in black
- Wall spacer for adjustment to the correct wall clearance
- Packaging and drilling template



Remote control model 4



# Zehnder Deseo Verso

## Electric-only operation



Model	Colour	H mm	L mm	Electrical output W	Price €
DVW-150-048/D	White	1500	475	600	2.101,88
DVB-150-048/D	Black	1500	475	600	2.101,88
DVM-150-048/D	Mirror	1500	475	600	2.237,49
DVW-175-048/D	White	1750	475	750	2.413,78
DVB-175-048/D	Black	1750	475	750	2.413,78
DVM-175-048/D	Mirror	1750	475	750	2.549,37

### Electric operation: Wall mounting

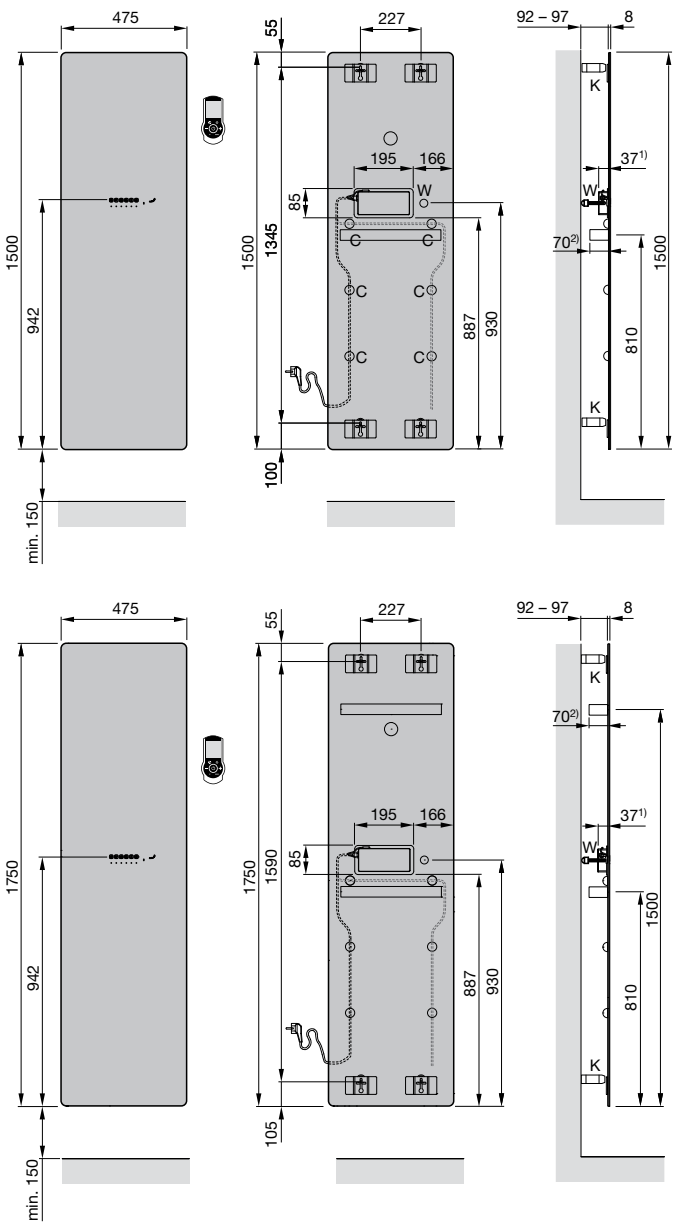

### Towel rail for extension to left or right as preferred

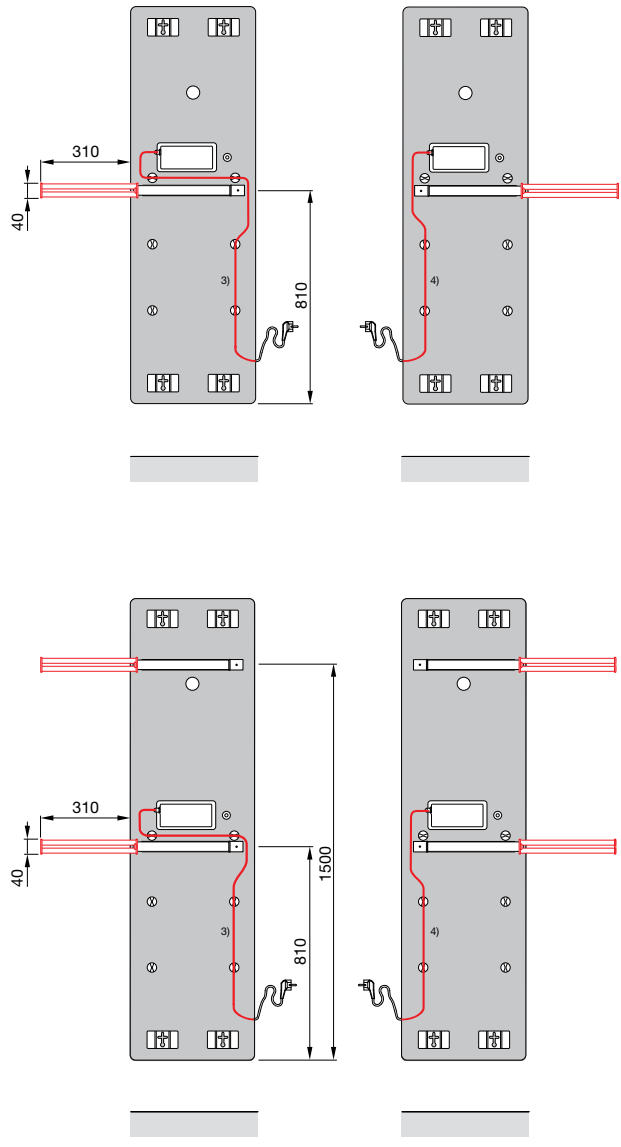

- H = Height
- L = Length
- K = Bracket
- C = Cable clip (for cable routing, see towel rail installation drawing)
- W = Wall spacer

- 1) Back of control box to back of radiator
  - 2) Back of towel rail to back of radiator
- Cable length available in the direction of the connection from bottom edge of radiator depending on cable routing:
- 3) 500 mm
  - 4) 800 mm

Dimensions in mm

For keywords, see 'Electric operation and Ecodesign Directive' on page 166

studio  
collection

## Zehnder Folio Belt

With an impressive flat surface, full closed edging and gently tapered silhouette – Folio from the Zehnder Studio Collection is highly appealing with its unusually light appearance. The design of this radiator, which has a projection of only 16 mm, has only been made possible by the development of innovative design elements and materials. The striking flat shape of Zehnder Folio is a result of innovative heating technology. The material and colour can be selected to make the radiator harmoniously blend into or create a pleasing contrast to your interior design concept. The oak, wenge, high-grade Macassar ebony or anodised aluminium finishes allow the heat to flow into the room elegantly and efficiently. The Zehnder Folio Belt version comes with one or two towel rails, whilst also providing maximum style and comfort to any bathroom.



Radiator surface: White Matt



## Zehnder Folio Belt



Radiator surface: anodised aluminium



Radiator surface: anodised aluminium / white matt

### Operation on central heating system

The impressive Zehnder Folio Belt from the Studio Collection features an unusually light and floating appearance. The design of this radiator, which has a projection of only 16 millimetres depth, has only been made possible by the development of innovative design elements and materials.

Heating register made of copper pipe Ø 12 mm, embedded in an aluminium honeycomb construction, which is enclosed by expanded natural graphite, 45° inclined edges made of polyamide. One or two (depending on model, according to overview of models) chrome-plated towel rails 40 x 4 mm, for installation at a fixed predefined position, included in scope of delivery.

Thermal output to EN 442, with CE marking. With two connections 1/2" female thread for flow/return at the bottom centre, distance of 50 mm, decorative directional air vent 1/2" at the top rear.

Front and back made of aluminium available in all colours according to the Zehnder colour chart as well as in the specified surfaces, back with anodised aluminium finish in matt black. Delivered ready to install with elegantly shaped wall brackets in radiator colour (anodised aluminium surface: wall brackets in matt black).

Operating pressure	max. 10.0 bar
Operating temperature	max. 80 °C
Height	..... mm
Length	..... mm
Model	.....

### Advantages

- Innovative heating technology
- Sleek, elegant design
- Smooth surface makes for easy cleaning
- Convenient for hanging up towels

### Construction

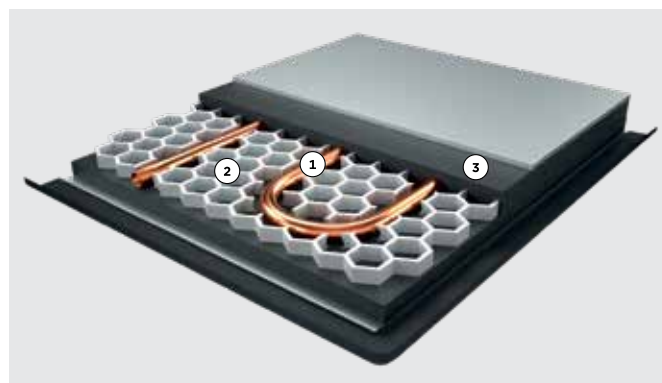

At the core of this decorative radiator is a heating register made of copper (1), embedded in an aluminium honeycomb construction (2), which is surrounded by expanded natural graphite (3). Thanks to this special, newly developed design and an innovative manufacturing technique, Zehnder was able to develop this very thin and ultra-light radiator without compromising on performance. The natural graphite used is an innovative material with ideal properties such as high thermal conductivity, low density and resistance to ageing.

## Zehnder Folio Belt

### Overview of models

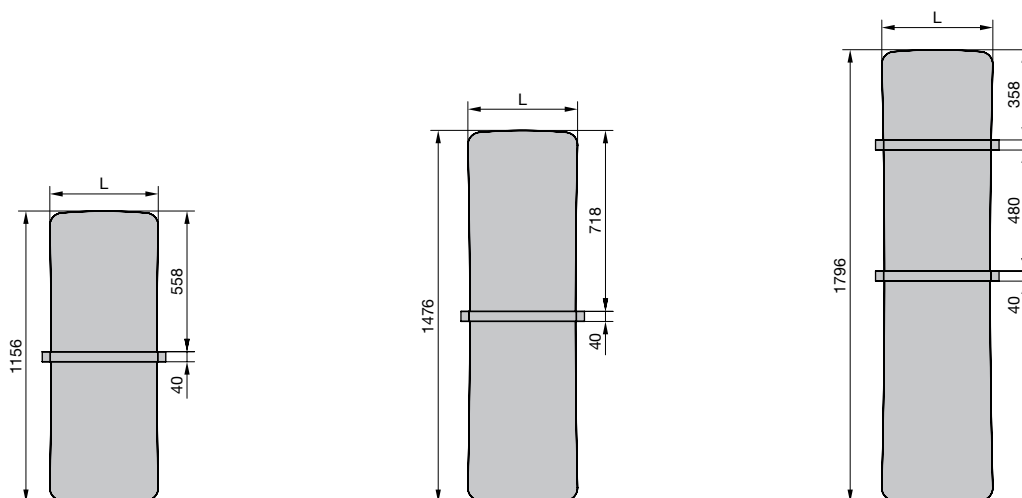

### Connection to hot water central heating system

Model	H mm	L mm	Thermal output			Exp. n	Classification Electric heating element Watt	V dm <sup>3</sup>	M kg	Price RAL 9016 €	Price <sup>①</sup> Cat. 1 €	
			EN 442 <sup>②</sup> W	70/55/24 W	55/45/24 W							55/45/20 W
<b>Painted version</b>												
<b>FZB-120-042</b>	1156	430	399	288	180	215	1.20	-	0.5	6.2	<b>1.326,01</b>	<b>1.657,51</b>
<b>FZB-150-042</b>	1476	435	504	364	227	271	1.20	-	0.6	8.5	<b>1.564,23</b>	<b>1.955,30</b>
<b>FZB-180-042</b>	1796	441	614	444	277	330	1.20	-	0.6	12.8	<b>1.750,03</b>	<b>2.187,54</b>
<b>FZB-120-052</b>	1156	530	485	350	219	261	1.20	-	0.6	8.0	<b>1.352,98</b>	<b>1.691,22</b>
<b>FZB-150-052</b>	1476	535	611	441	276	329	1.20	-	0.7	10.2	<b>1.595,70</b>	<b>1.994,63</b>
<b>FZB-180-052</b>	1796	540	762	551	344	410	1.20	-	0.8	14.7	<b>1.785,98</b>	<b>2.232,48</b>
<b>FZB-150-062</b>	1476	635	718	519	324	386	1.20	-	0.8	12.0	<b>1.646,65</b>	<b>2.058,31</b>
<b>FZB-180-062</b>	1796	640	912	657	409	488	1.21	-	1.0	16.4	<b>1.841,43</b>	<b>2.301,79</b>
<b>FZB-180-072</b>	1796	740	1064	765	474	566	1.22	-	1.2	18.1	<b>1.902,86</b>	<b>2.378,59</b>

### Standard scope of delivery for operation on central heating system

- Powder coating to DIN 55900, RAL 9016
- 1 or 2 chrome towel rails depending on version
- 2 x ½" connections at bottom, centre 50 mm
- ½" directional air vent
- Elegant wall brackets
- Packaging

① For special colours in categories 1 and 2, see special solutions and colour chart

② Thermal output to EN 442, ΔT 50 K (75/65/20 °C)



## Zehnder Folio Belt

Special solution on request (surcharge)	Article no.	Price €
▪ Special finish to category 2 (surcharge on cat. 1)	-	<b>146,76</b>
▪ Highly-polished metal surfaces: anodised aluminium	-	<b>as in Cat. 1</b>
▪ Zehnder thermostat	-	<b>see page 158</b>
▪ Zehnder valves, return screw connections and fittings	-	<b>see page 159 onwards</b>

### Operation on central heating system:

Wall mounting

Back cover

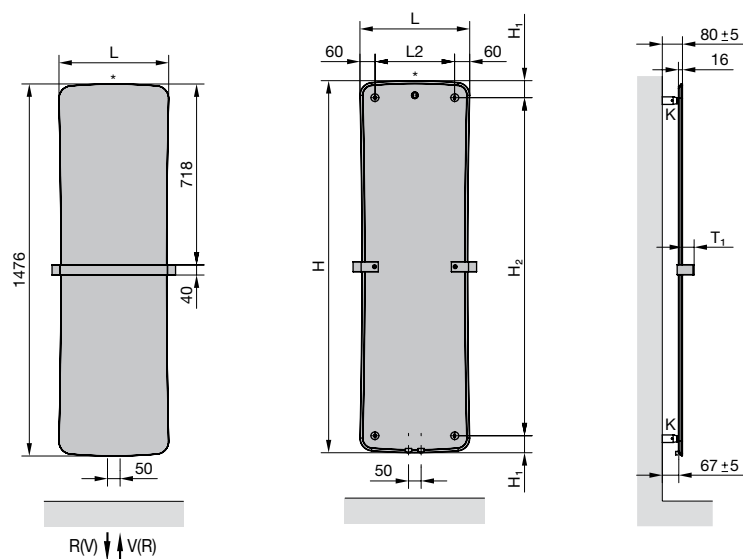

H = Height  
 L = Length  
 V = Flow  
 R = Return  
 K = Bracket(s)  
 \* = Vent

Dimensions in mm

Model	H mm	L mm	H <sub>1</sub> mm	H <sub>2</sub> mm	L <sub>2</sub> mm	L <sub>t</sub> mm	T <sub>1</sub> mm
FZB-120-042	1156	430	67	1022	310	490	46
FZB-150-042	1476	435	67.5	1341	315	490	46
FZB-180-042	1796	441	67.5	1661	321	490	46
FZB-120-052	1156	530	72	1012	410	590	48
FZB-150-052	1476	535	72.5	1331	415	590	48
FZB-180-052	1796	540	73	1650	420	590	48
FZB-150-062	1476	635	79	1318	515	690	50
FZB-180-062	1796	640	79.5	1637	520	690	50
FZB-180-072	1796	740	87	1622	620	790	52

studio  
collection

## Zehnder Folio Glass

Whether it's black, white or even in the form of a mirror, Folio Glass from the Zehnder Studio Collection integrates itself harmoniously into its interior environment with its elegant glass finish. The extremely slender, flat surface of only 10 mm, the fully closed edges and the gently tapering silhouette – Zehnder Folio Glass appeals with its unusually light appearance. The design of the glass surface floating in the room is the result of innovative technology. Controlled either by remote control or directly on the surface, it delivers maximum style and comfort. Zehnder Folio Glass – crystal-clear design for your home.



Radiator surface: Mirror



# Zehnder Folio Glass



Radiator surface: Black gloss



Radiator surface: White gloss

### Electric operation

Whether it's black, white or even in the form of a mirror, Zehnder Folio Glass from the Studio Collection integrates itself harmoniously into its interior environment with its elegant glass finish. With an extremely flat body of only 10 mm in depth, fully closed edges and a gently tapering silhouette, the Zehnder Folio Glass appeals with its unusually light appearance.

The design of the glass surface floating in the room is the result of innovative technology. Glass finish made of laminated safety glass of 2 x 4 mm, with an integrated electrically operated heating film. One or two chrome-plated towel rails can be ordered separately. For retrofitting at a fixed predefined position. Operation via control element (control panel) or chronosonda. Splash-proof IP44, mains power supply 230 V. Connection cable 1.2 m in length with two pin plug. White cable and plug, cable outlet downwards. Front available in black gloss, white gloss, mirror. Delivered ready to install with elegant wall brackets in black.

Output	..... W
Height	..... mm
Length	..... mm
Model	.....

### Advantages

- Minimalist, modern design that adds an elegant touch to the bathroom
- Intuitive, integrated control on the surface (control panel)
- Operation via control panel and remote control possible
- Durable safety glass
- Heated glass front provides pleasant warmth in next to no time
- Optionally with towel rails in chrome
- Ready-to-plug

### Standard scope of delivery for electric operation

- Glass surface made of laminated safety glass in glossy black, glossy white or as a mirror
- Remote control, with selectable modes: frost protection, economy, comfort, automatic, off, room temperature control, daily and weekly programme
- Control element (control panel) with 3 temperature levels (control of surface temperature) 45 °C, 55 °C, 65 °C, timer: 2 hours at 65 °C
- Mounting accessories in radiator colour or black for mirror radiators
- Wall spacer for adjustment to the correct wall clearance
- Packaging



Remote control model 4

## Zehnder Folio Glass

### Electric-only operation



Model	Colour	H mm	L mm	Electrical output W	Price €
FZW-180-042/D	White	1796	441	650	<b>1.698,89</b>
FZB-180-042/D	Black	1796	441	650	<b>1.698,89</b>
FZM-180-042/D	Mirror	1796	441	650	<b>1.698,89</b>
FZW-180-052/D	White	1796	540	800	<b>1.898,77</b>
FZB-180-052/D	Black	1796	540	800	<b>1.898,77</b>
FZM-180-052/D	Mirror	1796	540	800	<b>1.898,77</b>

Special solution on request (surcharge)	Article no.	Price €
▪ Chrome-plated towel rail for L = 441	468438	<b>231,59</b>
▪ Chrome-plated towel rail for L = 540	468448	<b>256,85</b>

### Electric operation:

Wall mounting with optional towel rail

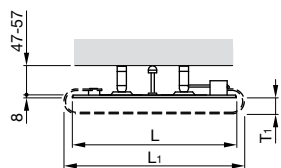
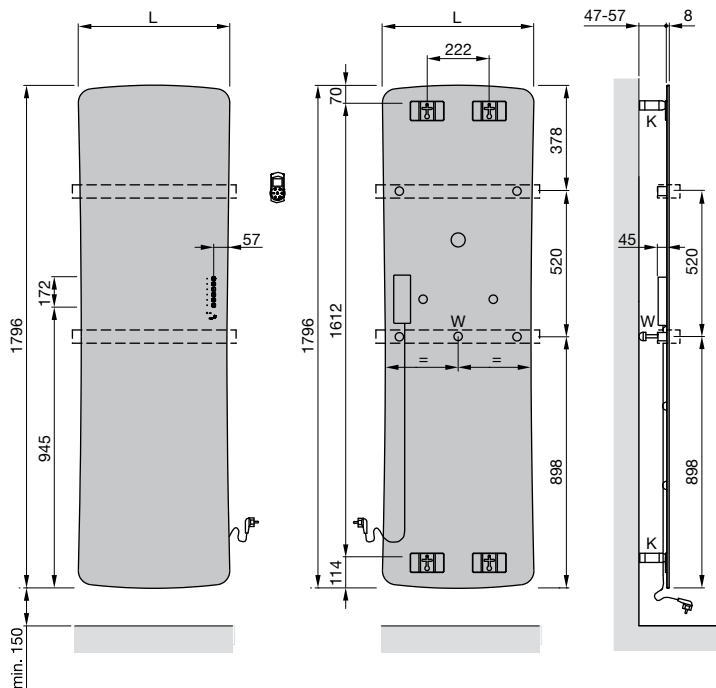

- H = Height
- L = Length
- K = Bracket
- W = Wall spacer
- L<sub>1</sub> = 490 for L = 441, 590 for L = 540
- T<sub>1</sub> = 46 for L = 441, 48 for L = 540

Dimensions in mm

For keywords, see 'Electric operation and Ecodesign Directive' on page 166

studio  
collection

## Zehnder Folio Hybrid

The extremely flat surface, the fully closed edges and the gently tapering silhouette – Folio Hybrid from the Zehnder Studio Collection appeals with its unusually light appearance. The design of this radiator, which has a projection of only 16 mm, has only been made possible by the development of innovative design elements and materials. The combination of a glossy and a matt surface allows the technology behind it to shine through: an electrically operated infrared heating element made of glass is located in the middle of the designer radiator, the rapid reaction time of which enables drying or warming of towels in the shortest time possible. The surrounding radiator is connected to the central heating system and provides cosy warmth in the room. With up to two chrome-plated towel rails, Zehnder Folio Hybrid also lends maximum style and comfort to the bathroom. Zehnder Folio Hybrid – the best of two heating philosophies.



Radiator surface: Black

## Zehnder Folio Hybrid



Radiator surface: White



Radiator surface: Black

### Hybrid operation

Zehnder Folio Hybrid from the Studio Collection combines two heating systems in one radiator. The design of this radiator, which has a projection of only 16 millimetres deep, has only been made possible by the development of innovative design elements and materials.

Heating register made of copper pipe Ø 12 mm, embedded in an aluminium honeycomb construction, which is enclosed by expanded natural graphite, 45° inclined edges made of polyamide. Glass finish made of laminated safety glass measuring 2 x 4 mm, with an integrated electrically operated heating film. The two heating systems (radiator and heating element) can be operated independently of each other. One or two (depending on model, according to overview of models) chrome-plated towel rails 40 x 4 mm, for installation at a fixed predefined position, included in scope of delivery. Thermal output to EN 442, with CE marking. With two connections ½" female thread for flow/return at the bottom centre, distance of 50 mm, decorative directional air vent ½" at the top rear. Operation of heating element via control element (control panel). Splash-proof IP45, protection class II, mains connection 230 V. Connection cable (1.1 m) with Euro plug.

White cable and plug, cable outlet towards the back. Front and back in aluminium available in white matt (0556) and black matt (0557). Heating element surface: Glass, white gloss and black gloss. Delivered ready to install with elegant wall brackets in radiator colour.

Operating pressure	max. 10.0 bar
Operating temperature	max. 80 °C
Height	..... mm
Length	..... mm
Model	.....

### Advantages

- The two heating systems can be operated independently of each other.
- Sleek, elegant design
- Smooth surface makes for easy cleaning
- Convenient for hanging up towels

### Construction



The decorative radiator consists of two different heating system technologies. The outer part is connected to the hot water central heating system. At the core of this system is a heating register made of copper (1), embedded in an aluminium honeycomb construction (2), which is surrounded by expanded natural graphite (3). The natural graphite used is an innovative material with ideal properties such as high thermal conductivity, low density and resistance to ageing. The inner part of the radiator consists of a heating film (4), which is sandwiched between two thin glass plates (5) of 4 mm each. Thanks to this special, newly developed design and an innovative manufacturing technique, Zehnder was able to develop this very thin and ultra-light radiator without compromising on performance.



## Zehnder Folio Hybrid

### Overview of models

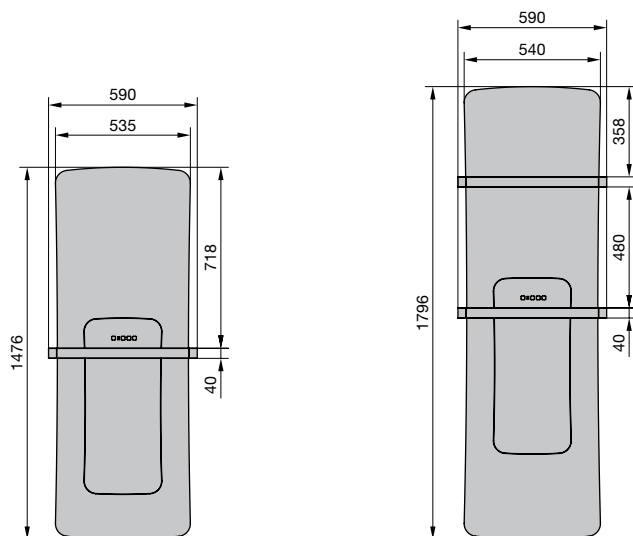

### Connection to hot water central heating system / electric operation

Model	H mm	L mm	Thermal output				Exp. n	Electrical output W	V dm <sup>3</sup>	M kg	Price €
			EN 442 W	70/55/24 W	55/45/24 W	55/45/20 W					
<b>Painted version, White matt (0556) / white gloss (radiator / heating element)</b>											
<b>FZHW-150-052/D</b>	1476	535	514	371	232	276	1.20	100	0.5	14.1	<b>1.921,07</b>
<b>FZHW-180-052/D</b>	1796	540	648	463	285	341	1.24	100	0.6	17.7	<b>2.092,12</b>
<b>Painted version, Black matt (0557) / black gloss (radiator / heating element)</b>											
<b>FZHB-150-052/D</b>	1476	535	514	371	232	276	1.20	100	0.5	14.1	<b>1.921,07</b>
<b>FZHB-180-052/D</b>	1796	540	648	463	285	341	1.24	100	0.6	17.7	<b>2.092,12</b>

Special solution on request (surcharge)	Article no.	Price €
▪ Zehnder thermostat	-	<b>see page 158</b>
▪ Zehnder valves, return screw connections and fittings	-	<b>see page 159 onwards</b>

### Standard scope of delivery for hybrid operation

- Powder-coated radiator according to DIN 55900  
Matt white or matt black
- Glass finish made of laminated safety glass in white gloss or black gloss
- 1 or 2 chrome towel rails depending on version
- 2 x ½" connections at bottom, centre 50 mm
- ½" directional air vent
- Integrated control element (control panel) with the following functions:  
Timer 30, 60 or 90 minutes, Off,  
Surface temperature: max. 65 °C
- Elegant wall brackets
- Packaging

Ⓞ Thermal output to EN 442, ΔT 50 K (75/65/20 °C)

# Zehnder Folio Hybrid

**Hybrid operation:**  
Wall mounting

Back cover

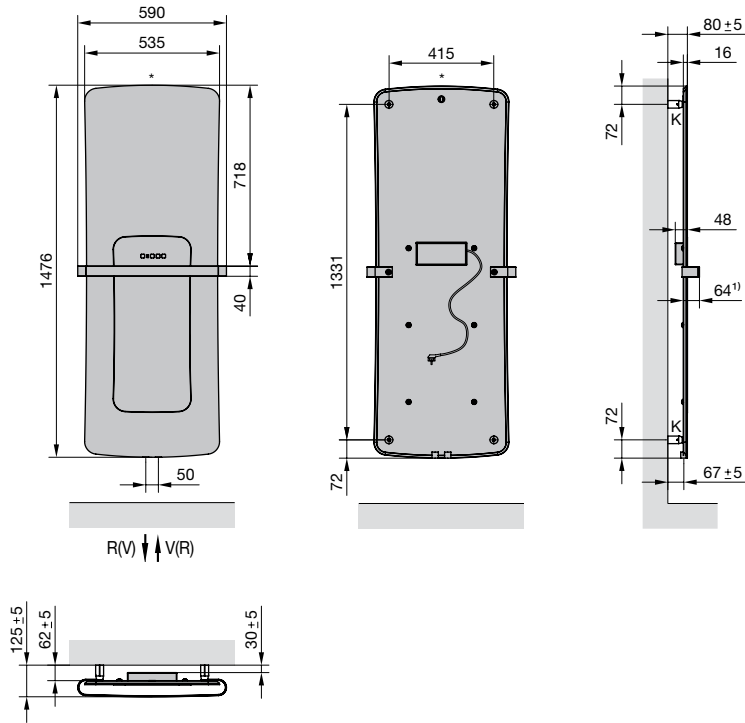

**Hybrid operation:**  
Wall mounting

Back cover

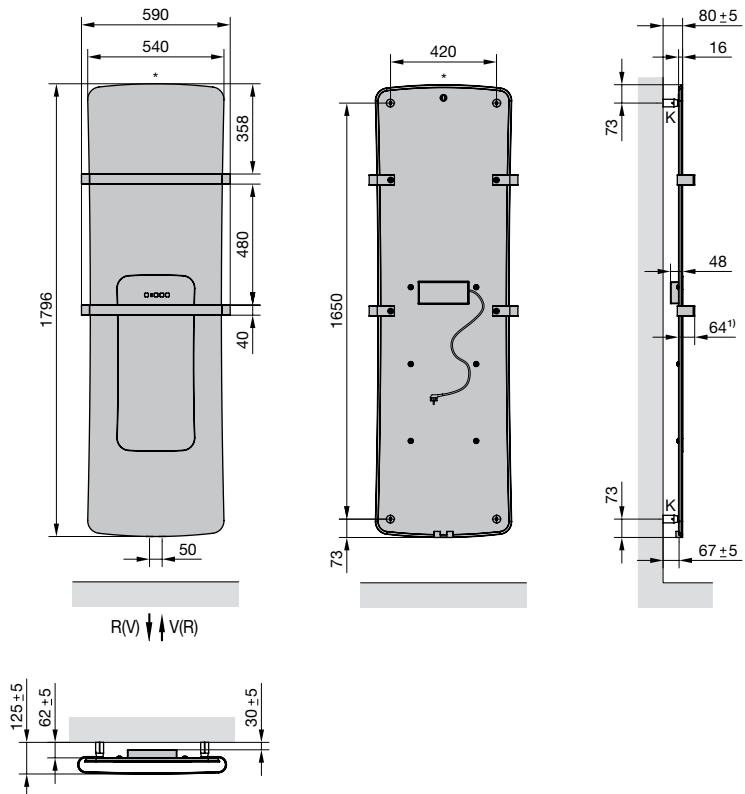

- V = Flow
- R = Return
- K = Bracket(s)
- \* = Vent

Dimensions in mm

1) Rear edge of radiator up to front edge of towel rail

studio  
collection

# Zehnder Zenita

Zehnder Zenita from the Studio Collection is an electric towel warmer, towel dryer, infrared radiator and boost heater all-in-one – in the form of an integrated unit that perfectly blends into modern bathroom architecture thanks to its minimalist design. The revolutionary Zehnder Zenita thermal comfort unit supplies pleasant heat quickly and ensures ultimate comfort heating in your bathroom independently of the central heating system. At the same time, you can dry and warm towels behind a visually appealing heated glass door. Available in white and black.



**DESIGN PLUS**  
powered by: **ISH**



Heated glass front: White

## Zehnder Zenia



Heated glass front: Black



Heated glass front: White

### Electric operation

Zehnder Zenia thermal comfort unit for rapidly heating and drying textiles, for operation in combination with a room heating system that covers the basic heat requirements. Zehnder Zenia comprises a housing for pre-assembly and thermal comfort unit for final assembly.

Option to select from either a rectangular frame or outer case as the housing for pre-assembly. Rectangular frame made of galvanised sheet steel for mounting the thermal comfort unit as an in-wall installation (in-wall systems, vertical frames or solid constructions) or for on-site integration into furniture. Aluminium decorative grille, painted, for mounting the thermal comfort unit as an on-wall installation.

Thermal comfort unit includes an inner case and an infrared heated glass front with the option to have the hinge on the left or right. Plastic inner case with integrated boost heater and glass cover with control panel and Bluetooth module. Heated glass door with internal towel rail for warming and drying textiles. Towel rail offers space for two towels of max. 140 x 70 cm each. Thermal comfort unit can either be operated via a simple control panel or an individually configurable app (available for both iOS and Android operating systems). Option of individual or combined operation of heated glass door (heated front face) and boost heater (functions: Boost function, towel warming or fast drying options, each with their own pre-set running time that can be modified via the app).

Thermal comfort unit with glass cover and infrared heated glass front available in black or white. Mains power supply for boost heater and heated glass door via common connection cable and mains power supply plug for connecting to on-site electrical connection box in the wall for a nominal voltage of 230 volts, total nominal output of 1225 W, splash-proof to IP 44 standards, complete with CE marking in accordance with DIN EN 60335 (Household and similar electrical appliances – Safety), suitable for optional connection in accordance with protection class I or II (DIN EN 61140), hinges certified in accordance with DIN EN 15570, heated glass door tested in accordance with VDI 6036 (requirements class 2), heated glass door made of safety glass – double-hardened (class B1 in accordance with EN 12600), system requirements for operation via app: iOS version 9.0 onwards, Android version 4.3 and 5.x onwards, Bluetooth from BLE onwards = Bluetooth 4.0 Low Energy.

Housing for pre-assembly model	.....
Thermal comfort unit for final assembly model	.....

### Advantages

- Hidden storage space ensures a tidy bathroom
- Heat readily available on demand for pre-heating rooms and towels with the integrated boost heater
- Radiant heat from the heated glass door creates a feeling of cosiness
- The intelligent drying function significantly reduces the build-up of bacteria on damp towels and textiles
- User-friendly operation with individual configuration options via an intuitive control panel or the app
- Smooth surfaces make for easy cleaning
- Low energy consumption of ≤ 0.5 W in stand-by mode for increased energy efficiency



## Zehnder Zenia

### Overview of models

#### Electric-only operation

Thermal comfort unit for final assembly



Model	Colour	H mm	L mm	Boost heater output W	Heated glass door Electric output W	Price €
-------	--------	---------	---------	--------------------------------	---	------------

#### With heated glass door hinged on the right

ZENRW-100-045/X	White	1000	450	1000	225	2.183,54
ZENRB-100-045/X	Black	1000	450	1000	225	2.183,54

#### With heated glass door hinged on the left

ZENLW-100-045/X	White	1000	450	1000	225	2.183,54
ZENLB-100-045/X	Black	1000	450	1000	225	2.183,54

Thermal comfort unit for final assembly

Hinge on left

Hinge on right

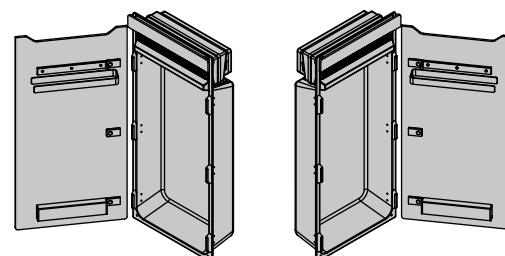

#### Standard scope of delivery for thermal comfort unit

- Plastic inner case painted in RAL 000 25 00
- Boost heater with filter housing that can be removed for cleaning
- Glass cover with control panel and Bluetooth module
- Heated glass door with the option to have the hinge on the left or right and a mains power supply plug for connecting to the control box in the inner case
- Hinges with soft-close function including fixings to mount and align the door on the inner case
- Brushed stainless steel towel rail with fixings
- Glass cover and heated glass door in a single colour – either black or white
- Connection cable with mains power supply plug
- Packaging

Housing for pre-assembly

Model	H mm	L mm	Price €
-------	---------	---------	------------

#### Rectangular frame (required for in-wall installation or integration into bathroom furniture, etc.)

ZENFRM-100-045	977	430	228,96
----------------	-----	-----	--------

#### Outer case (required for on-wall installation)

ZENFRD-100-045	1003	451	515,16
----------------	------	-----	--------

Housing for pre-assembly

Rectangular frame

Outer case

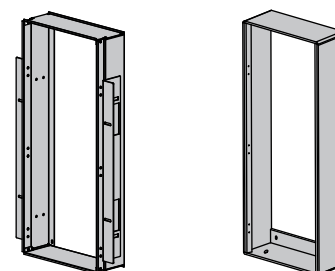

#### Standard scope of delivery for rectangular frame

- 4-part rectangular frame made of galvanised sheet steel complete with slots for mounting in an in-wall system
- 2 galvanised mounting brackets for mounting and aligning the rectangular frame to surrounding components
- Mains power supply socket for connecting to on-site electrical connection box
- Mounting accessories
- Cardboard cover for protection
- Packaging

#### Standard scope of delivery for outer case

- Single-piece, aluminium outer case, surface painted in white aluminium, complete with fixings on the back for mounting on prefabricated walls
- Mains power supply socket for connecting to on-site electrical connection box
- Mounting accessories
- Packaging

For keywords, see 'Electric operation and Ecodesign Directive' on page 166

**Rectangular frame (required for in-wall installation or integration into bathroom furniture, etc.):**

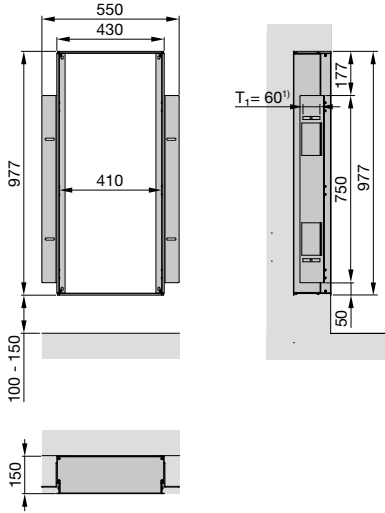

**Outer case (required for on-wall installation):**

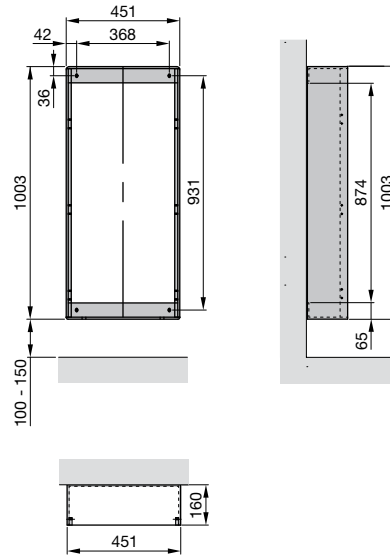

1)  $T_1$  = Depth adjustment of rectangular frame

**Thermal comfort unit for final assembly:**

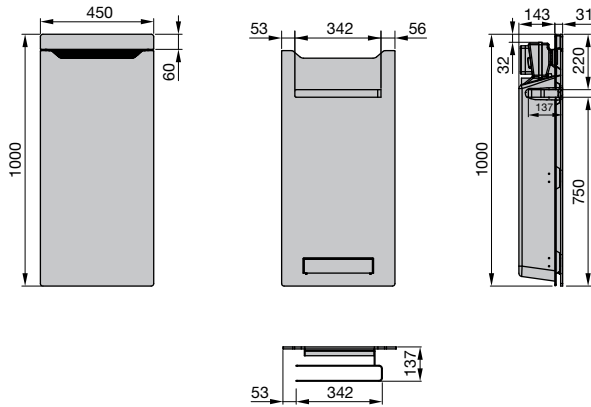

**Zehnder Zenia with in-wall installation**

**Zehnder Zenia with on-wall installation**

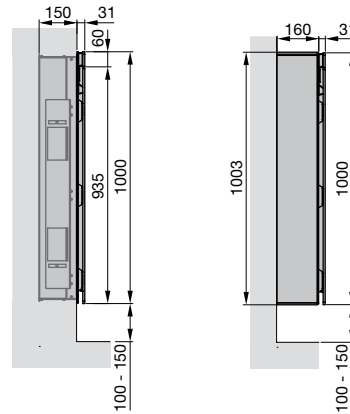

**Hinge on left**

**Hinge on right**

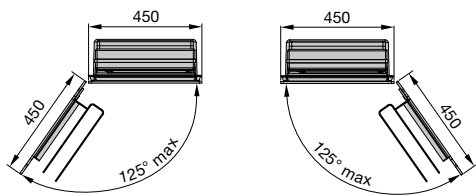

Dimensions in mm



## Zehnder Zenia

### Installation options:

In-wall installation with rectangular frame



In-furniture installation with rectangular frame



On-wall installation with outer case



### Design of thermal comfort unit:



- ① Heated glass door with soft-close hinge
- ② Towel rail for hanging a maximum of two large bath towels of 140 x 70 cm
- ③ Glass cover with control panel and Bluetooth module
- ④ Suction area of the integrated boost heater with removable filter housing
- ⑤ Outlet area of the integrated boost heater
- ⑥ Easy-to-clean, plastic inner case

### Functions:

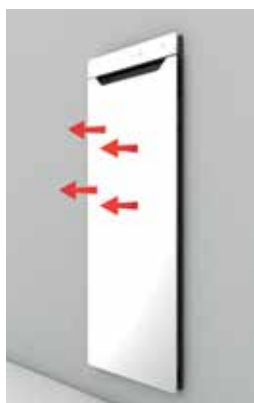

Pleasant radiant heat provided by integrated heated glass door.



Suction of room air beneath the glass cover by the boost heater. Warm, even airflow from above warms and dries textiles quickly.



Even, gentle distribution of the heated air via an outlet behind the heated glass door.

### Operation:



Straightforward selection of the four functions on the control panel. The intelligent app control also offers a range of additional functions: Remote control, daily and weekly programmes, options to change the factory settings, and support features (including video instructions for filter replacement and help with fault notifications).

## Zehnder Zenia

### Integration in special burgbad furniture



The Zehnder Zenia thermal comfort unit can be purchased from Zehnder retailers for direct integration into the specially designed burgbad cabinets. No additional housing is required for pre-assembly of Zehnder Zenia. A 230 V mains power supply is all you need.

The tall or mid-height wall cabinet options have been especially designed to accommodate Zehnder Zenia and can be purchased from burgbad retailers. The scope of delivery from burgbad includes a suitable wall mounting bracket for Zehnder Zenia along with a mains power supply socket for connecting to an on-site electrical connection cable.



Dimensions in mm

The Zehnder Zenia thermal comfort unit can be purchased from Zehnder retailers for direct integration into the specially designed burgbad cabinets. No additional housing is required for pre-assembly of Zehnder Zenia. A 230 V mains power supply is all you need.

The tall wall cabinet options have been especially designed to accommodate Zehnder Zenia and can be purchased from burgbad retailers. The scope of delivery from burgbad includes a suitable wall mounting bracket for Zehnder Zenia along with a mains power supply socket for connecting to an onsite electrical connection cable.

studio  
collection

# Zehnder Tetris

The Zehnder Tetris radiator, designed by King & Miranda, brings an exclusive fusion of nature and architecture to your space. Inspired by the flow of a river and the rhythm of flight, this design piece balances proportions and provides space to breathe. Tetris boasts clean lines accentuated by precision manufacturing techniques, and offers a practical solution for your towel hanging needs while bringing a sense of movement into your bathroom and kitchen. Available in various sizes and colours to perfectly match your style and interior design.



Radiator surface: Olive Green

## Zehnder Tetris



Radiator surface: Pastel Blue



Radiator surface: Black Quartz, with heating element IHC



Radiator surface: Golden Sand, with heating element IHE

### Operation on hot water central heating system

Zehnder Tetris from the Studio Collection has all steel construction: 40mm x 30mm D-shaped outer frame, 60mm x 30mm oval inner tubes with 4x 1/2" female thread connections. Radiator in standard colour RAL 9016, in special colour or surface. Delivered ready to install with wall brackets. Not suitable for use on domestic hot water system. Heat output determined in accordance with EN 442.

Operating pressure	max. 4.0 bar
Operating temperature	max. 95 °C

### Advantages

- Individuality through extraordinary design
- Generous variety of towel storage
- Hidden fixing studs on the back of the radiator
- Large pipe spacing allows easy cleaning
- High performance

Hydronic version cannot be used with an electric heating element IHE or IHC.

### Electric operation

Zehnder Tetris from the Studio Collection has all steel construction: 40mm x 30mm D-shaped outer frame, 60mm x 30mm oval inner tubes with 4x 1/2" female thread connections. Radiator in standard colour RAL 9016, in special colour or surface.

Version with heating element IHE: With built-in immersion heater, installed at bottom right, without control option, control unit in white (if radiator is white ) or chrome (for all other radiator surfaces) for mains power supply of 230 V.

Version with heating element IHC: With built-in immersion heater, installed at bottom right and control unit with LED matrix display, control unit white, black or grey (depending on radiator colour), cable with length 1,2m and plug in colour of control unit, for mains power supply of 230 V, IP 65.

### Special benefits for electric operation with IHC

- Adjustable surface temperature
- Temperature controls for each room
- Timer function
- Daily and weekly programming via the app
- Integrated energy efficiency in line with ecodesign requirements
- Ready-to-plug



## Zehnder Tetris

### Overview of models

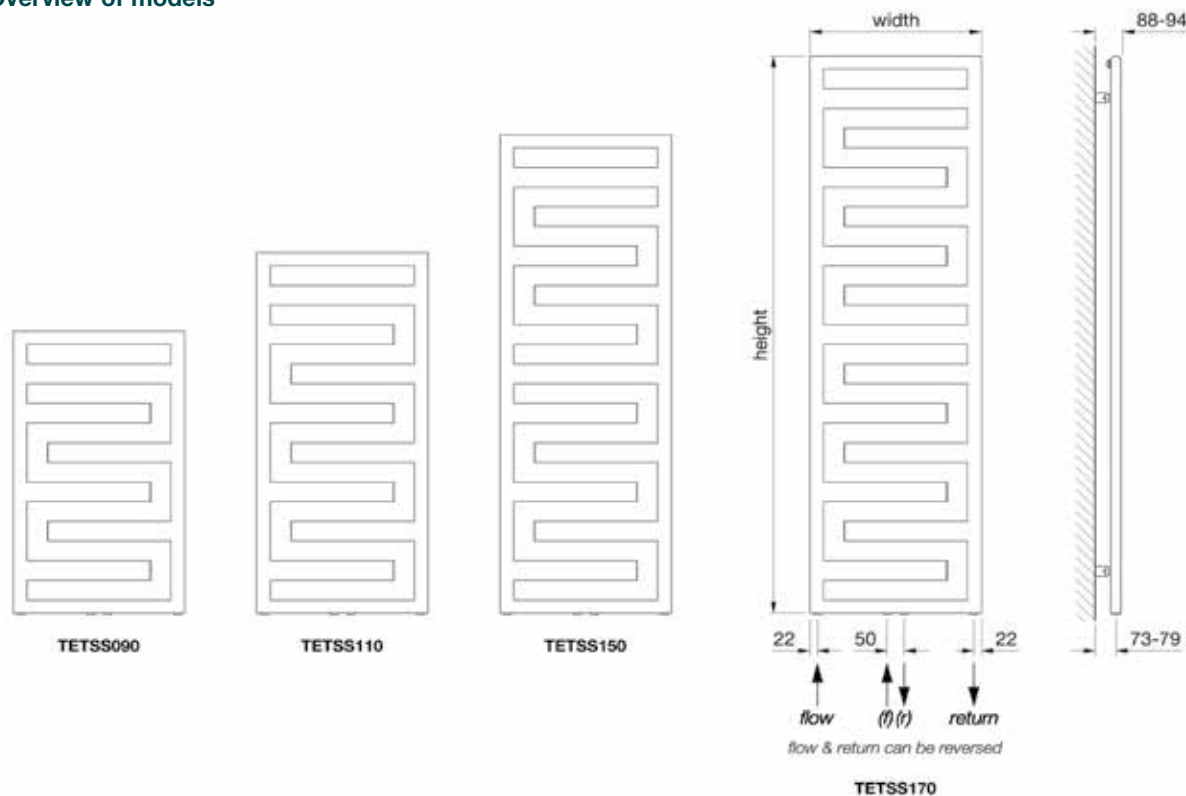

### Connection to hot water central heating system

Model	H mm	L mm	EN 442 <sup>Ⓢ</sup> W	Thermal output			Exp. n	V dm <sup>3</sup>	M kg	Price RAL 9016 €	Price <sup>Ⓢ</sup> Cat. 1 €
				70/55/24 W	55/45/24 W	55/45/20 W					
<b>Painted version</b>											
<b>TETSS090050WZZZ</b>	860	500	388	277	169	203	1.25	5.7	7.9	<b>290,59</b>	<b>363,23</b>
<b>TETSS090060WZZZ</b>	860	600	455	324	199	238	1.25	6.6	7.5	<b>303,30</b>	<b>379,12</b>
<b>TETSS110050WZZZ</b>	1100	500	493	350	214	257	1.26	6.8	10.3	<b>333,51</b>	<b>416,89</b>
<b>TETSS110060WZZZ</b>	1100	600	579	413	253	303	1.25	8.1	12.2	<b>349,84</b>	<b>437,30</b>
<b>TETSS150050WZZZ</b>	1460	500	655	466	284	342	1.26	8.9	13.4	<b>400,32</b>	<b>500,40</b>
<b>TETSS150060WZZZ</b>	1460	600	768	544	331	398	1.27	10.6	15.9	<b>422,02</b>	<b>527,53</b>
<b>TETSS170050WZZZ</b>	1700	500	765	544	332	399	1.26	10.4	15.5	<b>459,04</b>	<b>573,80</b>
<b>TETSS170060WZZZ</b>	1700	600	898	637	387	466	1.27	12.3	18.4	<b>484,41</b>	<b>605,52</b>

Special solution on request (surcharge)	Article no.	Price €
▪ Special finish to category 2 (surcharge on cat. 1)	-	<b>146,76</b>

### Standard scope of delivery for operation on central heating system

- Powder coating to DIN 55900, RAL 9016
- 4 x ½" connections for flow, return, centre 50 mm
- 1 x ½" connection at top middle
- Mounting accessories in colour of radiator
- Packaging

Ⓢ For special colours in categories 1 and 2, see "Special solutions" and "Colour chart"

Ⓢ Thermal output to EN 442, ΔT 50 K (75/65/20°C)

## Electric-only operation with new electric platform



Model	H mm	L mm	Classification Electric heating element Watt	Price RAL 9016 €		Price Cat. 1 <sup>①</sup> €	
				Heating element IHC (C)	Heating element IHE (A)	Heating element IHC (C)	Heating element IHE (A)
<b>Painted version</b>							
TETSS090050E_ZD	860	500	400	550,37	347,82	687,97	434,77
TETSS090060E_ZD	860	600	400	562,45	359,89	703,06	449,87
TETSS110050E_ZD	1100	500	400	588,30	385,74	735,37	482,18
TETSS110060E_ZD	1100	600	600	611,01	404,95	763,76	506,18
TETSS150050E_ZD	1460	500	600	657,98	451,91	822,47	564,89
TETSS150060E_ZD	1460	600	600	678,46	472,39	848,07	590,49
TETSS170050E_ZD	1700	500	600	711,70	505,64	889,63	632,05
TETSS170060E_ZD	1700	600	900	761,86	544,79	952,33	680,98

Special solution on request (surcharge)	Article no.	Price €
▪ Special finish to category 2 (surcharge on cat. 1)	-	146,76

### Standard scope of delivery for electric operation

- Powder coating to DIN 55900, RAL 9016
- Filled with heat transfer fluid
- With integrated electric heating element IHE or IHC, bottom right
- Electric heating element cover in colour white, black or grey (depending on radiator colour)
- Mounting accessories in colour of radiator
- Packaging

① For special colours in categories 1 and 2, see “Special solutions” and “Colour chart”

studio  
collection

# Zehnder Pera

Less is definitely more with this chic stainless steel towel rail as the refined construction allows the tubes to meld gently into one another. The Zehnder Pera brings a quiet elegance to both modern and traditional bathrooms.



Radiator surface: Brushed Bronze

## Zehnder Pera



Radiator surface: *Brushed Black Chrome*



Radiator surface: *Brushed Bronze*

### Operation on central heating system

Design radiator Zehnder Pera, made of horizontally arranged stainless steel tubes and vertical collector pipes. Tube connections are soldered with no visible seams. Large horizontal spacing between tubes allows for easy hanging and removal of towels.

Horizontal round tubes Ø 32 mm, vertical collector pipes Ø 38 mm. Heat output according to EN 442, with CE marking. ½" connections at the bottom left and right of the collector pipes for flow and return. ¼" vent at the top center, facing the rear.

Radiator is made of hand-polished stainless steel as standard. Optional PVD coating available in Brushed Black Chrome, or Brushed Bronze. Delivered ready for installation with elegant wall brackets and a vent valve, including packaging.

Operating pressure	max. 4,0 bar
Operating temperature	max. 90 °C
Height	..... mm
Length	..... mm
Model	.....

### Advantages

- Modern and timeless design
- Generous spacing between tubes for convenient hanging of multiple towels
- Ergonomic shape allows for easy and quick cleaning
- Durable hand-polished stainless steel surface
- Available with PVD coating in Brushed Black Chrome, or Brushed Bronze



## Zehnder Pera

### Overview of models

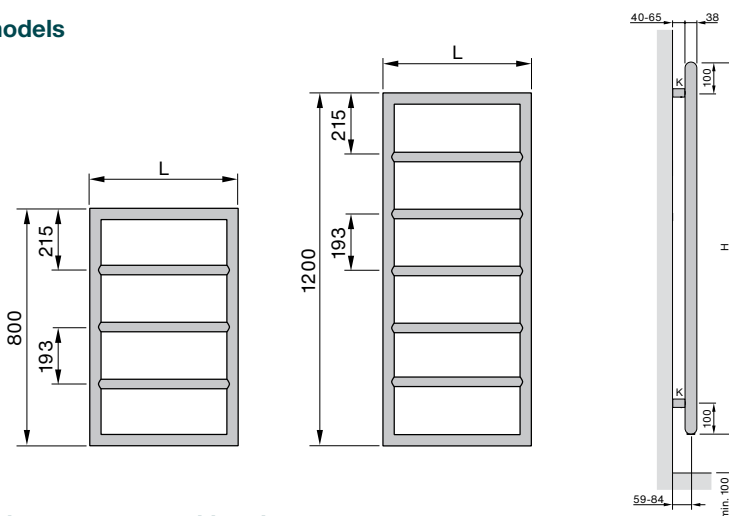

### Connection to hot water central heating system

Model	H mm	L mm	Thermal output			Exp. n	Classification Electric heating element Watt	V dm <sup>3</sup>	M kg	Price €
			EN 442 <sup>Ⓢ</sup> W	55/45/24 W	50/40/22 W					
<b>Stainless steel version</b>										
PER-120-50-9516	1200	500	269	119	102	1.23	-	4.5	5.6	1.259,37
<b>Brushed Black Chrome version</b>										
PER-080-50-N211	800	500	187	81	69	1.27	-	3.1	4.3	1.214,59
<b>Brushed Bronze version</b>										
PER-120-50-N213	1200	500	269	119	102	1.23	-	4.5	5.6	1.390,19

Special solution on request (surcharge)	Article no.	Price €
▪ Zehnder thermostat	-	see page 158
▪ Zehnder valves, return screw connections and fittings	-	see page 159 onwards

### Standard scope of delivery for operation on central heating system

- Hand-polished stainless steel, optionally with PVD coating
- 2 x 1/2" connections for flow and return, 1 x 1/4" vent
- 1/4" vent valve
- Mounting accessories
- Packaging



Brushed Black  
Chrome  
(code N211)



Brushed Bronze  
(code N213)

Ⓢ Thermal output to EN 442, ΔT 50 K (75/65/20 °C)

# Notes

Grid area for notes.

**always the best climate**

**Premium Collection**

from page 54

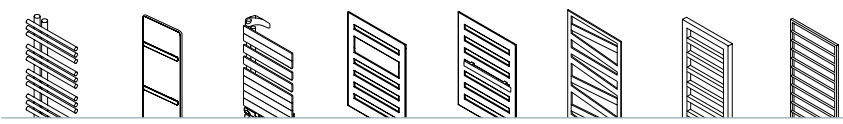

**Quality Collection**

from page 94

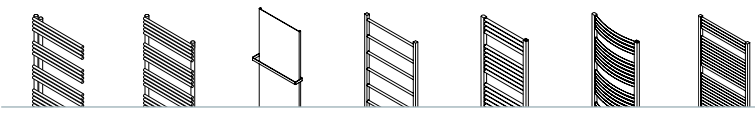

**Bathroom Essentials**

from page 119

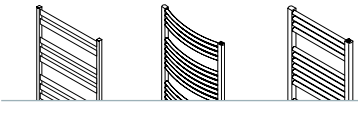

**Accessories and  
general information**

from page 136



## Zehnder Yucca Asym



Radiator surface: Chrome



Dual energy operation with Wivar II heating element



Radiator surface: Chrome, Traffic White

### Operation on hot water central heating system

Zehnder Yucca Asym decorative radiator made from horizontally arranged precision steel tubes and vertical header tubes, without visible welds and fully welded due to capstan welding technology. Sets of 3 horizontal tubes each branch asymmetrically from the laterally arranged manifolds. Towels can be slid in from the side to warm or dry. Single or double-layer version. Header tubes Ø 30 mm, horizontal tubes Ø 20 mm.

Thermal outputs to EN 442, with CE marking. 4 x 1/2" connection at the ends of the header tubes for flow, return, electric heating element and venting. Connection size 50 mm for using a connection fitting in single or twin-tube operation. Radiator with powder coating, in colour RAL 9016 as standard, in special colour or chrome on request. Delivered ready to install with matching wall brackets in colour of radiator.

Operating pressure	max. 12,0 bar
Operating temperature	max. 110°C
Height	..... mm
Length	..... mm
Model	.....

### Benefits

- Small depth
- Easy to clean (lambswool cleaning brush)
- Ideal for hanging up towels
- Can be used as a room divider
- Transparent look
- Connection from top possible
- Dual energy operation with connection fitting possible
- Right-hand or left-hand installation possible

### Electric operation

Zehnder Yucca Asym decorative radiator, electric-only, made from horizontally arranged precision steel tubes and vertical header tubes, sets of 3 horizontal tubes each branch asymmetrically from the laterally arranged manifolds. Electric version filled with heat transfer fluid, for connection to 230 V mains supply. With 1,2 m connection cable. Radiator with powder coating, in colour RAL 9016 as standard, in special colour or chrome on request. Delivered ready to install with matching wall brackets in colour of radiator.

### Electric operation with heating element IHC

Heating element IHC with integrated control function and modular control concept. Basic functions can be set directly on the heating element. For an even more comfortable and easy control, remote control EASY (RCE, available as accessory) or the Zehnder Connect app can be used. Control unit colour in either white, grey or black, depending on radiator colour, built-in on outer collector tube. Connection cable an plug in radiator colour, protection class IP54.

### Electric operation with heating element IHE

Heating element IHE (without control function) for application in combination with on-site control (e. g. BMS systems). Control unit colour either white or chrome, depending on radiator colour, built-in on outer collector tube. Connection cable with Schuko plug in white or grey, protection class IP65.

### Electric operation with heating element RACY-C

Heating element RACY-C, degree of protection IP44 (splash-proof), with Euro plug, installation at bottom left., cover in radiator colour. Separate, battery-operated remote control device model 2 for controlling the room temperature.

# Zehnder Yucca Asym

## Overview of models

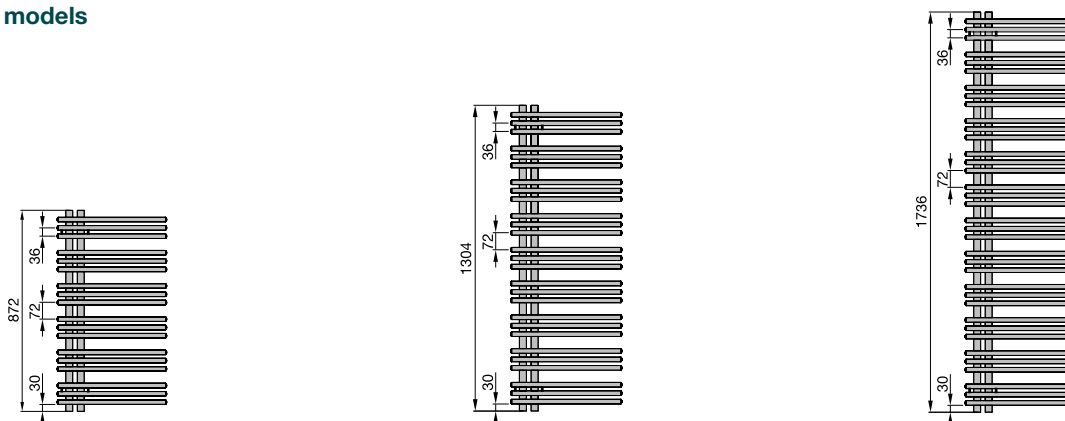

## Connection to hot water central heating system or for dual energy operation

Model	H mm	L mm	Thermal output				Exp. n	Classification Electric heating element Watt	V dm <sup>3</sup>	M kg	Price RAL 9016 €	Price <sup>①</sup> Cat. 1 €
			EN 442 <sup>③</sup> W	70/55/24 W	55/45/24 W	55/45/20 W						

### Single-layer version, painted version

YA-130-040	1304	378	430	305	185	223	1,27	300	3,6	11,1	<b>509,20</b>	<b>636,50</b>
YA-170-040	1736	378	571	405	246	296	1,27	300	4,8	14,8	<b>619,35</b>	<b>759,30</b>
YA-090-050	872	478	351	250	152	183	1,26	300	2,8	9,2	<b>462,49</b>	<b>578,11</b>
YA-130-050	1304	478	517	367	223	268	1,27	300	4,2	13,3	<b>582,55</b>	<b>714,95</b>
YA-170-050	1736	478	686	486	296	356	1,27	600	5,6	17,9	<b>693,76</b>	<b>867,20</b>
YA-130-060	1304	578	599	425	258	311	1,27	600	4,7	15,8	<b>638,03</b>	<b>783,79</b>
YA-170-060	1736	578	795	564	342	412	1,27	600	6,3	21,1	<b>784,88</b>	<b>981,10</b>

### Double-layer version, painted version

YAD-130-040	1304	378	628	443	267	322	1,29	600	5,7	19,4	<b>744,24</b>	<b>930,30</b>
YAD-170-040	1736	378	825	580	348	421	1,30	600	7,7	25,9	<b>900,80</b>	<b>1.126,01</b>
YAD-090-050	872	478	529	374	226	273	1,28	300	4,6	16,0	<b>637,36</b>	<b>796,70</b>
YAD-130-050	1304	478	763	538	324	392	1,29	600	6,9	23,9	<b>854,12</b>	<b>1.067,65</b>
YAD-170-050	1736	478	1002	705	423	512	1,30	900	9,1	32,0	<b>1.046,57</b>	<b>1.308,21</b>
YAD-130-060	1304	578	893	630	380	458	1,29	600	8,0	28,7	<b>956,22</b>	<b>1.195,28</b>
YAD-170-060	1736	578	1173	825	495	599	1,30	900	10,6	38,9	<b>1.218,91</b>	<b>1.523,63</b>

Model	H mm	L mm	Thermal output				Exp. n	Classification Electric heating element Watt	V dm <sup>3</sup>	M kg	Price Chrome €
			EN 442 <sup>③</sup> W	70/55/24 W	55/45/24 W	55/45/20 W					

### Single-layer version, chrome-plated version

YAC-130-040	1304	378	308	217	130	157	1,30	300	3,6	11,1	<b>1.230,79</b>
YAC-170-040	1736	378	408	286	171	207	1,31	300	4,8	14,8	<b>1.579,97</b>
YAC-090-050	872	478	254	179	108	130	1,29	300	2,8	9,2	<b>1.008,74</b>
YAC-130-050	1304	478	371	261	157	189	1,30	300	4,2	13,3	<b>1.423,56</b>
YAC-170-050	1736	478	492	345	206	250	1,31	300	5,6	17,9	<b>1.842,29</b>
YAC-130-060	1304	578	432	304	182	221	1,30	300	4,7	15,8	<b>1.622,07</b>
YAC-170-060	1736	578	572	401	240	291	1,31	600	6,3	21,1	<b>2.113,06</b>

① For special colours in categories 1 and 2, see "Special solutions" and "Colour chart"

③ Thermal output to EN 442, ΔT 50 K (75/65/20°C)

## Zehnder Yucca Asym



### Electric-only operation with new electric platform

Model	H <sup>ⓐ</sup> mm	L mm	Classification Electric heating element Watt	Price RAL 9016 €		Price Cat. 1 <sup>ⓑ</sup> €	
				Heating element IHC (C)	Heating element IHE (A)	Heating element IHC (C)	Heating element IHE (A)

#### Single-layer version, right-hand, painted version

YAZSR130040E_ZD	1304	378	400	1.128,29	751,82	1.410,36	939,77
YAZSR090050E_ZD	872	478	300	1.056,31	662,92	1.320,38	828,65
YAZSR130050E_ZD	1304	478	400	1.184,03	804,79	1.480,04	1.005,98
YAZSR130060E_ZD	1304	578	600	1.248,61	889,17	1.560,76	1.111,46
YAZSR170060E_ZD	1736	578	900	1.472,78	1.069,76	1.840,98	1.337,20

#### Single-layer version, left-hand, painted version

YAZSL130040E_ZD	1304	378	400	1.128,29	751,82	1.410,36	939,77
YAZSL090050E_ZD	872	478	300	1.056,31	662,92	1.320,38	828,65
YAZSL130050E_ZD	1304	478	400	1.184,03	804,79	1.480,04	1.005,98
YAZSL130060E_ZD	1304	578	600	1.286,44	889,17	1.608,06	1.111,46
YAZSL170060E_ZD	1736	578	900	1.472,78	1.066,14	1.840,98	1.332,68

Model	H <sup>ⓐ</sup> mm	L mm	Classification Electric heating element Watt	Price Chrome €	
				Heating element IHC (C)	Heating element IHE (A)

#### Single-layer version, right-hand, chrome-plated version

YAZCR130040E_ZD	1304	378	400	1.860,61	1.322,13
YAZCR090050E_ZD	872	478	300	1.567,30	1.099,06
YAZCR130050E_ZD	1304	478	400	2.111,06	1.540,68
YAZCR130060E_ZD	1304	578	600	2.377,86	1.744,99
YAZCR170060E_ZD	1736	578	900	2.986,60	2.247,20

#### Single-layer version, left-hand, chrome-plated version

YAZCL130040E_ZD	1304	378	400	1.860,61	1.322,13
YAZCL090050E_ZD	872	478	300	1.567,30	1.099,06
YAZCL130050E_ZD	1304	478	400	2.111,06	1.540,68
YAZCL130060E_ZD	1304	578	600	2.377,86	1.744,99
YAZCL170060E_ZD	1736	578	900	2.986,60	2.273,95

ⓐ For special colours in categories 1 and 2, see "Special solutions" and "Colour chart"

ⓑ Total height w/o heating element. For IHC +128 mm, for IHE +50 mm.

For legend, see "Electric operation and Ecodesign Directive" on page 166

## Zehnder Yucca Asym



### Electric-only operation

Model	H <sup>Ⓢ</sup> mm	L mm	Classification Electric heating element Watt	Price RAL 9016 €	Price <sup>①</sup> Cat. 1 €
-------	----------------------	---------	---	------------------------	-----------------------------------

#### Single-layer version, right-hand, painted version

YAER-130-40/GD	1329	378	500	1.218,47	1.523,09
YAER-090-50/GD	897	478	300	1.142,93	1.428,67
YAER-130-50/GD	1329	478	500	1.259,50	1.574,37
YAER-130-60/GD	1329	578	500	1.328,82	1.661,02
YAER-170-60/GD	1761	578	750	1.521,88	1.902,35

#### Single-layer version, left-hand, painted version

YAEL-130-40/GD	1329	378	500	1.236,93	1.546,17
YAEL-090-50/GD	897	478	300	1.142,93	1.428,67
YAEL-130-50/GD	1329	478	500	1.259,50	1.574,37
YAEL-130-60/GD	1329	578	500	1.328,82	1.661,02
YAEL-170-60/GD	1761	578	750	1.521,88	1.902,35

Model	H <sup>Ⓢ</sup> mm	L mm	Classification Electric heating element Watt	Price Chrome €
-------	----------------------	---------	---	----------------------

#### Single-layer version, right-hand, chrome-plated version

YAECR-130-40/GD	1329	378	300	1.561,90
YAECR-090-50/GD	897	478	300	1.321,75
YAECR-130-50/GD	1329	478	300	1.753,64
YAECR-130-60/GD	1329	578	300	1.986,16
YAECR-170-60/GD	1761	578	500	2.483,31

#### Single-layer version, left-hand, chrome-plated version

YAACL-130-40/GD	1329	378	300	1.561,90
YAACL-090-50/GD	897	478	300	1.321,75
YAACL-130-50/GD	1329	478	300	1.753,64
YAACL-130-60/GD	1329	578	300	1.986,16
YAACL-170-60/GD	1761	578	500	2.483,31

① For special colours in categories 1 and 2, see "Special solutions" and "Colour chart"

Ⓢ Total height incl. heating element

For legend, see "Electric operation and Ecodesign Directive" on page 166

## Zehnder Yucca Asym

### Standard scope of delivery for operation on hot water central heating system

- Powder coating to DIN 55900, RAL 9016
- 4 x ½" connections for flow, return, venting
- 2 x ½" directional air vent
- Mounting accessories in colour of radiator
- Packaging

### Standard scope of delivery for electric operation

- Powder coating to DIN 55900, RAL 9016
- Filled with non-flammable heat-transfer fluid (frost-proof to -10°C)
- Mounting accessories in colour of radiator
- Packaging
- Version with heating element IHC: With built-in immersion heater in outer manifold and control unit with LED matrix display, control unit white, black or grey (depending on radiator colour), cable and plug in colour of control unit
- Version with heating element IHE: With built-in immersion heater in outer manifold, without control option, control unit in white (if radiator is white ) or chrome (for all other radiator surfaces).
- Version with integrated heating element RACY-C: with remote control device, incl. battery, with selectable operating modes: manual (above room temperature), weekly programme, timer, off. Electric heating element cover in colour of radiator.

Special solution on request (surcharge)	Article number	Price €
▪ Special finish to category 2 (surcharge on cat. 1)	6500011640	146,76
▪ Galvanized and painted	-	On request
▪ Remote control EASY for IHC (RCE)*	887970	133,38
▪ Heating element WIVAR II for dual energy operation 	-	See page 157
▪ Accessories	-	See page 145
▪ Lambswool cleaning brush	601040	60,41
▪ Connection fitting with short cover (operation on central heating system only), cover in white	976021	172,59
▪ Connection fitting with short cover (operation on central heating system only), cover in special finish	976029	184,97
▪ Connection fitting with short cover (operation on central heating system only), cover in chrome	976028	229,18
▪ Connection fitting with long cover (for dual energy operation with WIVAR II), cover in white	976031	172,59
▪ Connection fitting with long cover (for dual energy operation with WIVAR II), cover in special finish, incl. cover parts set	976039	233,28
▪ Connection fitting with long cover (for dual energy operation with WIVAR II), cover in chrome, incl. cover parts set	976038	289,54
▪ Zehnder thermostat DH, M 30 x 1,5, white	819050	35,02
▪ Zehnder thermostat DH, M 30 x 1,5, chrome	819058	53,36
▪ Zehnder valves and lockshield valves	-	See p. 159 onwards



Remote control EASY can be ordered as accessory for heating element IHC.

# Zehnder Yucca Asym

**Operation on hot water central heating system:**  
Right-hand version <sup>1)</sup> Single-layer

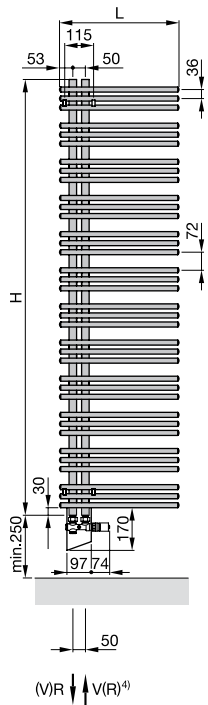

Double-layer

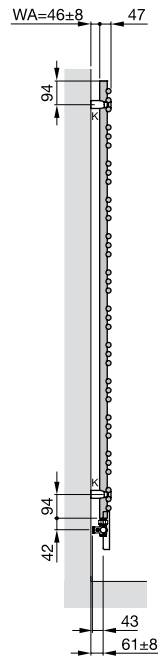

Room divider installation <sup>3)</sup>

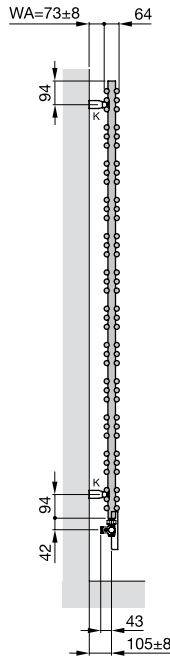

**Electric operation:**  
with heating element IHC <sup>5)</sup>

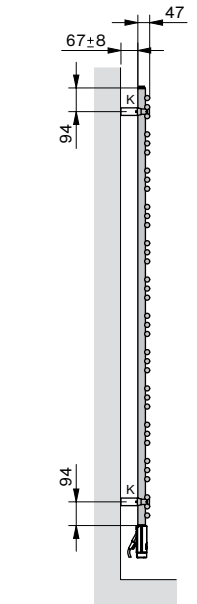
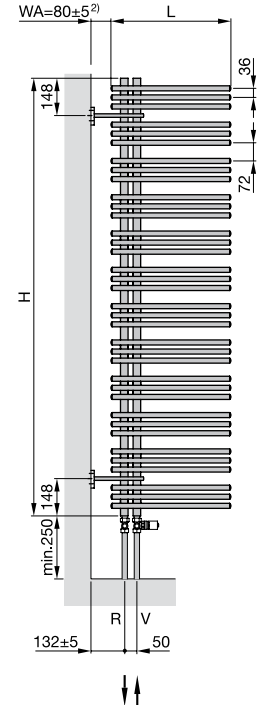

**Dual energy operation:**  
Detailed view  
Right-hand version  
Connection fitting with long cover and integrated electric heating element WIVAR II.

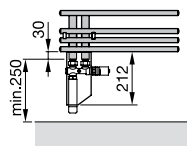

**Dual energy operation:**  
Detailed view  
Right-hand version  
Connection fitting with short cover and electric heating element IHC.

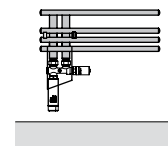

**Electric operation:**  
Detailed view  
Left-hand version  
with integrated heating element IHC.

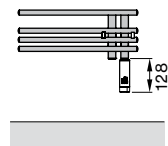

**Electric operation:**  
Detailed view  
Right-hand version  
with integrated heating element RACY-C.

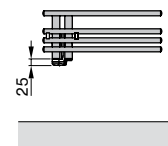

**Electric operation:**  
Detailed view  
Left-hand version  
with integrated heating element RACY-C.

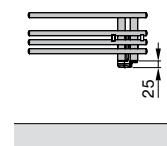

- H = Height
- L = Length
- K = Bracket
- WA = Wall clearance
- V = Flow
- R = Return

Dimensions in mm

1) Models for operation on hot water central heating systems can be installed as right-hand version or left-hand version  
 2) Brackets with modified wall clearance on request  
 3) Dual energy operation with room divider installation possible only when T-piece is used (see "Accessories")  
 4) Flow is possible on both sides of the connection fitting  
 5) Wall clearances also apply for heating element RACY-C

## Zehnder Vitalo Bar



Radiator colour: Cream



Zehnder EasyFit - with tegrated valve incl. thermostat



### Operation on hot water central heating system

Zehnder Vitalo Bar decorative radiator with smooth aluminium front and back plus copper tube heating register in graphite/aluminium construction.

Surrounding, sealed frame of black polyamide. Includes one or two chrome towel rails, depending on the model. Thermal output to EN 442, with CE marking. With two ½" female thread connections for flow and return, positioned at bottom centre, spacing 50 mm.

Completo version with concealed Zehnder EasyFit connection box with flow/return 2 x ¾" external thread at the back, centred 50 mm clearance, including pre-adjustable valve AV 9 and adjustment dial and folding mechanism for installation.

Radiator with powder coating, in colour RAL 9016 as standard, or in special colour or with an anodised aluminium surface on request, delivered ready to install with wall brackets and packaging.

Operating pressure	max. 10 bar
Operating pressure Zehnder EasyFit	max. 6 bar
Operating temperature	max. 80 °C
Height	..... mm
Length	..... mm
Model	.....

### Benefits

- Innovative technology for efficient heating
- Extremely slim and noticeably light
- High proportion of radiation
- A striking profile for a distinctive look
- Simple accommodation of textiles with towel rail accessible from one side
- Hygienic and simple to clean
- Supports integrated connection due to Zehnder EasyFit

### Electric operation

Zehnder Vitalo Bar decorative radiator with smooth aluminium front and back plus heating cable in graphite/aluminium construction. Surrounding, sealed frame of black polyamide. Includes one or two chrome towel rails, depending on the model.

With CE marking. Separate battery-operated remote control device model 2, control box RACY-S and no visible control elements on the radiator. Splash-proof for mains power supply of 230 V. Connection cable (1,2 m) with Schuko plug.

Radiator with powder coating, in colour RAL 9016 as standard, or in special colour or with an anodised aluminium surface on request, Delivered ready to install with wall brackets and packaging.

### Special benefits for electric operation with RACY-S

- Fast thermal radiation
- Remote control device can be positioned as required
- Regulated room temperature
- Comfortable operation as needed by customisable daily and weekly programmes
- Energy-efficient and comfortable heating via innovative open window detection
- Low energy consumption in stand-by mode (≤ 0,5 W)
- Keylock can be activated as required
- Timer function for up to 2 hours
- Ready-to-plug

## Zehnder Vitalo Bar

### Overview of models

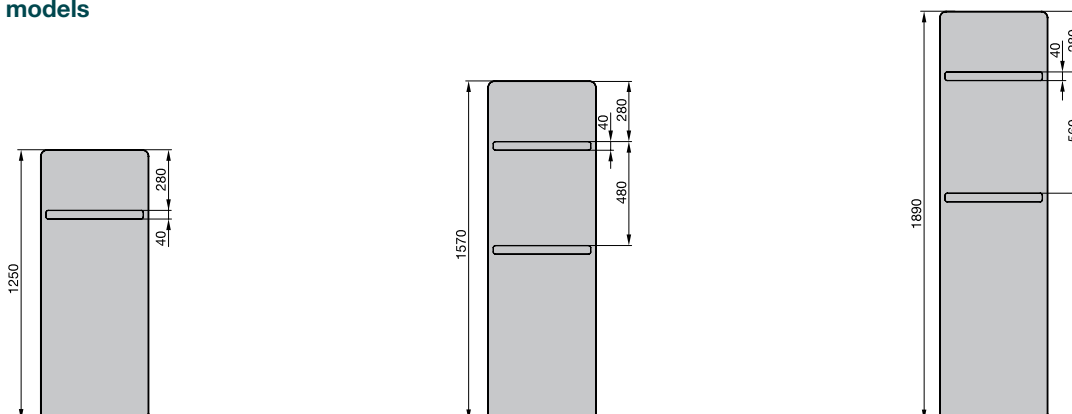

### Connection to hot water central heating system, 50 mm centre connections

Model	H mm	L mm	Thermal output				Exp. n	Electric output Watt	V dm <sup>3</sup>	M kg	Price RAL 9016 €	Price <sup>①</sup> Cat. 1 €
			EN 442 <sup>②</sup> W	70/55/24 W	55/45/24 W	55/45/20 W						
<b>Painted version with towel rail in chrome</b>												
VIP-125-040	1250	400	465	334	207	248	1,22	-	0,7	7,0	1.421,14	1.776,43
VIP-160-040	1570	400	546	394	246	294	1,20	-	0,7	9,3	1.676,40	2.095,50
VIP-190-040	1890	400	673	485	302	360	1,21	-	0,9	10,9	1.876,49	2.345,61
VIP-125-050	1250	500	555	399	247	295	1,22	-	0,8	8,7	1.449,52	1.811,91
VIP-160-050	1570	500	676	487	303	362	1,21	-	0,9	11,4	1.711,07	2.138,84
VIP-190-050	1890	500	834	601	374	446	1,21	-	1,1	12,7	1.914,30	2.392,88
VIP-125-060	1250	600	641	462	287	343	1,21	-	0,9	10,5	1.495,23	1.869,03
VIP-160-060	1570	600	806	577	359	429	1,21	-	1,0	13,6	1.766,20	2.207,76
VIP-190-060	1890	600	994	716	446	532	1,21	-	1,3	14,6	1.974,19	2.467,73

### Connection to hot water central heating system, Zehnder EasyFit connection box

Model	H mm	L mm	Thermal output				Exp. n	Electric output Watt	V dm <sup>3</sup>	M kg	Price RAL 9016 €	Price <sup>①</sup> Cat. 1 €
			EN 442 <sup>②</sup> W	70/55/24 W	55/45/24 W	55/45/20 W						
<b>Painted version with towel rail in chrome</b>												
VIPK-125-040	1275	400	465	334	207	248	1,22	-	0,7	9,5	1.783,53	2.229,41
VIPK-160-040	1595	400	546	394	246	294	1,20	-	0,7	11,8	2.038,78	2.548,48
VIPK-190-040	1915	400	673	485	302	360	1,21	-	0,9	13,4	2.238,86	2.798,58
VIPK-125-050	1275	500	555	399	247	295	1,22	-	0,8	11,2	1.811,90	2.264,87
VIPK-160-050	1595	500	676	487	303	362	1,21	-	0,9	13,9	2.073,46	2.591,82
VIPK-190-050	1915	500	834	601	374	446	1,21	-	1,1	15,2	2.276,70	2.845,87
VIPK-125-060	1275	600	641	462	287	343	1,21	-	0,9	13,0	1.857,60	2.321,99
VIPK-160-060	1595	600	806	581	361	431	1,21	-	1,0	16,1	2.128,58	2.660,72
VIPK-190-060	1915	600	994	716	446	532	1,21	-	1,3	17,1	2.336,57	2.920,71

① For special colours in categories 1 and 2, see "Special solutions" and "Colour chart"

② Thermal output to EN 442, ΔT 50 K (75/65/20°C)

③ Total height incl. Zehnder EasyFit connection box

## Zehnder Vitalo Bar



### Electric-only operation

Model	H <sup>Ⓢ</sup> mm	L mm	Electric output Watt	Price RAL 9016 €	Price <sup>①</sup> Cat. 1 €
-------	----------------------	---------	----------------------------	------------------------	-----------------------------------

Painted version with towel rail in chrome					
VIPE-125-040/GD	1250	400	350	1.833,95	2.109,04
VIPE-160-040/GD	1570	400	500	2.164,82	2.489,54
VIPE-190-040/GD	1890	400	500	2.421,64	2.784,89
VIPE-160-050/GD	1570	500	500	2.208,92	2.540,27
VIPE-190-050/GD	1890	500	750	2.472,06	2.842,87
VIPE-190-060/GD	1890	600	1000	2.547,70	2.929,85

Model	H <sup>Ⓢ</sup> mm	L mm	Electric output Watt	Price Alu. anod. €
-------	----------------------	---------	----------------------------	--------------------------

Anodised aluminium version, with towel rail in chrome				
VIPES-160-40/GD	1570	400	350	2.489,54
VIPES-190-40/GD	1890	400	500	2.784,89
VIPES-190-50/GD	1890	500	500	2.842,87
VIPES-190-60/GD	1890	600	750	2.929,85

### Standard scope of delivery for operation on hot water central heating system

- Powder coating to DIN 55900, RAL 9016
- 2 x ½" connections for flow/return, central, 50 mm
- 2 x double nipple ¾" external thread x ½" external thread for joining to fitting
- EasyFit: Connection box in colour of radiator; connection fitting 2 x ¾" Eurocone to back with 50 mm incl. shut-off for dual-pipe system, thermostat valve with remote control and adjustment dial beneath the radiator; flexible connection
- ½" decorative chrome directional air vent
- Towel rail in chrome (1 x for 1250 mm height, 2 x for 1570 mm and 1890 mm height), fixing point on right
- Mounting accessories in colour of radiator
- Packaging

### Standard scope of delivery for electric operation

- Powder coating to DIN 55900, RAL 9016
- Remote control device, incl. batteries, with selectable operating modes: manual (above room temperature), weekly programme, timer, off
- Towel rail in chrome (1 x for 1250 mm height, 2 x for 1570 mm and 1890 mm height)
- Mounting accessories in colour of radiator
- Packaging

Special solution on request (surcharge)	Article number	Price €
▪ Special finish to category 2 (surcharge on cat. 1)	A700011640	146,76
▪ Highly-polished metal surfaces: anodised aluminium	-	As in Cat. 1
▪ Surface in metal look: stainless steel look	-	As in Cat. 1
▪ Integrated valve incl. thermostat; note Zehnder EasyFit table	-	See table
▪ Radiator with towel rail, fixing point on left (surcharge on standard version)	-	97,20
▪ Zehnder valves, lockshield valves and connection fittings	-	See p. 159 onwards

① For special colours in categories 1 and 2, see "Special solutions" and "Colour chart"  
For legend, see "Electric operation and Ecodesign Directive" on page 166

## Zehnder Vitalo Bar

### Operation on hot water central heating system:

Wall mounting

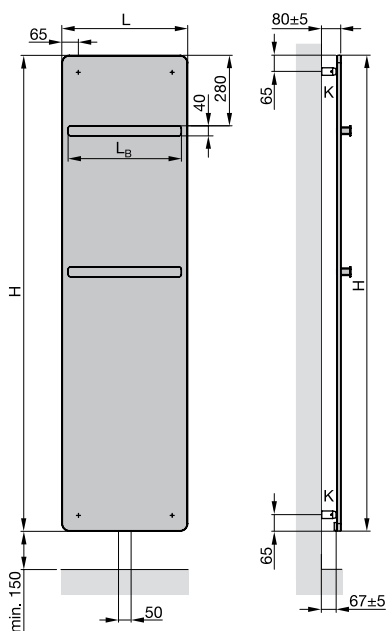

R(V)↕V(R)

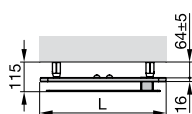

### Operation on hot water central heating system with Zehnder EasyFit connection box<sup>1)</sup>:

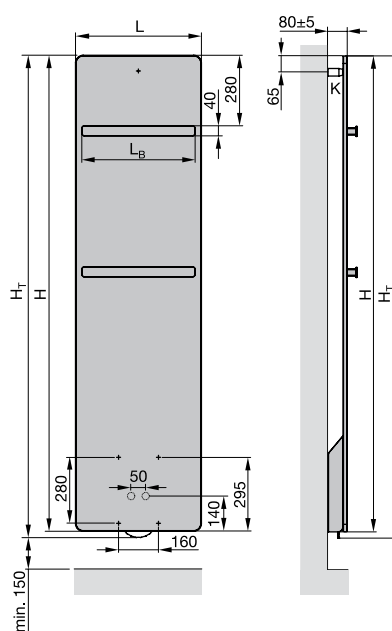

R(V)↕V(R)

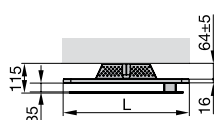

### Electric operation:

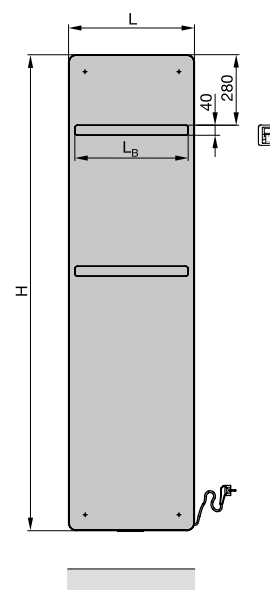

Accessory EasyFit connection box

- H = Height
- H<sub>T</sub> = Total height, H + 25 mm
- L = Length
- L<sub>B</sub> = Length of towel rail, L - 50 mm<sup>2)</sup>
- V = Flow
- R = Return
- K = Bracket

Dimensions in mm

- 1) Without internal by-pass for single-tube operation
- 2) Towel rail 1 x for H = 1250 mm, 2 x for H = 1570 mm and 1890 mm

## Zehnder Roda Twist Spa Air



Radiator colour: Reseda Green



### Electric operation

Zehnder Roda Twist Spa Air decorative radiator for electric-only operation; made from horizontally arranged precision flat tubes and vertical header tubes, without visible welds, fully welded. Single-sided, asymmetrically arranged flat tubes 70 x 11 mm branching laterally from the manifold Ø 38 mm; radiator can be pivoted 180° from the wall; towels can be slid in from the side to warm or dry.

Dual electrical heating system, comprising electric heating element integrated into the outer manifold and concealed boost heater arranged behind the radiator with flow direction downwards and forwards.

Common mains power supply of 230 V for electric heating element and boost heater, connection cable 1,2 m with Euro plug; splash-proof, IP24, with CE marking; separate battery-operated infrared control device model 3 for controlling the electric heating element and for controlling the boost heater with different operating modes; decorative radiator filled with heat transfer fluid.

Radiator with powder coating, in colour RAL 9016 as standard, in special colour on request. Delivered ready to install with wall brackets incl. cover in colour of radiator.

### Benefits

- Practical access to the hand towel from the side
- Pivotable by 180°
- Separate or mixed operation of electric heating element and boost heater possible
- Boost function for rapid heating
- Radiant heat and reheating time
- Daily programme, weekly programme can be activated as an option (Eco and Comfort mode)
- Extra hygiene through cleanable air filter
- Energy-efficient and comfortable heating via innovative open window detection
- Low energy consumption in stand-by mode ( $\leq 0,5$  W)
- Ready-to-plug

### Standard scope of delivery for electric operation

- Powder coating to DIN 55900, RAL 9016
- Electric heating element with selectable operating modes: manual (above room temperature) daily programme, off, weekly programme can be activated as an option (Eco and Comfort mode)
- Electric boost heater with timer function, incl. over-heat protection
- Infrared control device model 3 incl. batteries
- Radiator filled with heat transfer fluid
- Mounting accessories for wall mounting with pivot function
- Packaging

# Zehnder Roda Twist Spa Air

## Electric-only operation



Model	H <sup>①</sup> mm	L mm	Output Boost heater Watt	Classification Electric heating element Watt	Price RAL 9016 €	Price <sup>②</sup> Cat. 1 €
-------	----------------------	---------	--------------------------------	---	------------------------	-----------------------------------

Painted version, right-hand version						
ROER-100-55/IPS	966	550	1000	500	1.467,67	1.687,82
ROER-140-55/IPS	1344	550	1000	750	1.595,65	1.834,99
ROER-190-55/IPS	1837	550	1000	1000	1.882,36	2.164,71

Painted version, left-hand version						
ROEL-100-55/IPS	966	550	1000	500	1.467,67	1.687,82
ROEL-140-55/IPS	1344	550	1000	750	1.595,65	1.834,99
ROEL-190-55/IPS	1837	550	1000	1000	1.882,36	2.164,71

Special solution on request (surcharge)	Article number	Price €
▪ Special finish to category 2 (surcharge on cat. 1)	R200011640	146,76
▪ Towel rail, magnetic, overall length 399 mm	471108	269,02
▪ Towel hook, magnetic	470328	135,31

### Electric operation: Left-hand version

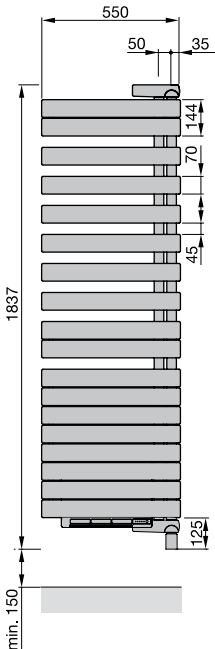

### Right-hand version

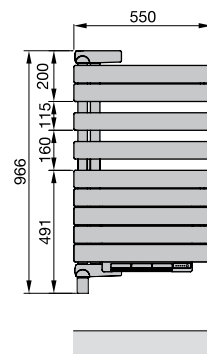
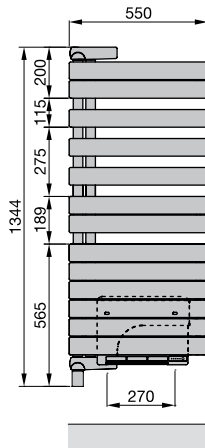
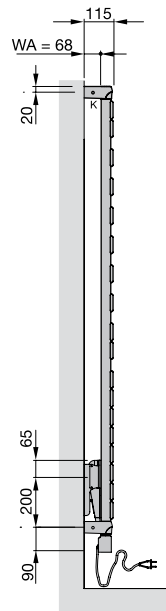

WA = Wall clearance  
K = Bracket

Dimensions in mm

① For special colours in categories 1 and 2, see “Special solutions” and “Colour chart”  
② Total height incl. electric heating element and bracket

For legend, see “Electric operation and Ecodesign Directive” on page 166

## Zehnder Metropolitan Spa



Radiator colour: *Brown Quartz*

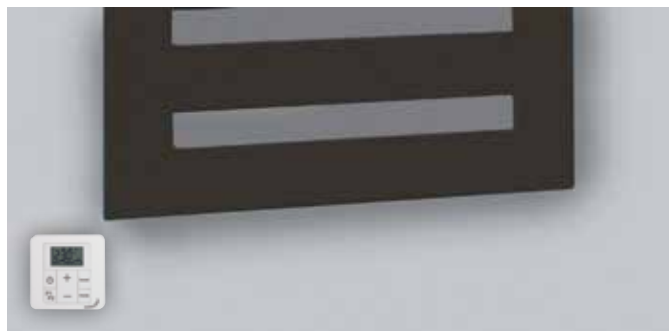
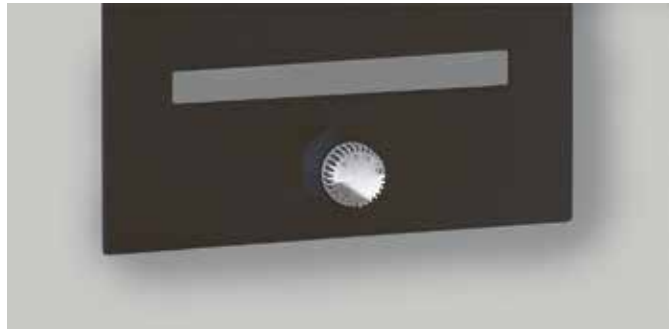

### Operation on hot water central heating system

Zehnder Metropolitan Spa decorative radiator for use as a bathroom and towel radiator. Flat-looking radiator with recessed slots, made from horizontally arranged flat tubes 70 x 8 mm, which are connected with a surrounding triangular profile frame without visible welded joints. With one or more openings (depending on height) for hanging towels. Thermal output to EN 442, with CE marking. With 4 connections at bottom, 2 x central 1/2" for flow/return, spacing 50 mm and 2 x 1/2", outside left and right, with directional air vent. Connections for Completto version: Flow/return 2 x 3/4" external thread at the back, centred 50 mm spacing, including valve and thermostat integrated into front panel.

Connections for dual energy operation: Flow/return 2 x 1/2" at bottom centre, spacing 50 mm and factory covered integrated electric heating element RACY-S, bottom right, with separate remote control device model 2.

Radiator with powder coating, in colour RAL 9016 as standard, in special colour on request. Delivered ready to install with matching wall brackets and packaging.

Operating pressure	max. 4,0 bar
Hot water central heating system operating temperature	max. 110°C
Dual energy operation operating temperature (model METM)	max. 95°C
Height	..... mm
Length	..... mm
Model	.....

### Benefits

- Innovative radiator with flat design
- Clean look due to innovative welding technology
- Ideal towel hanging through large cut-out(s)
- Individually positionable designer towel hook
- Elegant solutions for valve integration on request
- Dual energy operation: electric heating element RACY-S integrated elegantly
- Side connections for easy replacement of old DIN standard radiators on request

### Electric operation

Zehnder Metropolitan Spa decorative radiator, electric-only, for use as a bathroom and towel radiator. Flat-looking radiator with recessed slots, made from horizontally arranged flat tubes 70 x 8 mm, which are connected with a surrounding triangular profile frame without visible welded joints. With one or more openings (depending on height) for hanging towels. Electric version filled with heat transfer fluid, for connection to 230 V mains supply. With 1,2 m connection cable. Radiator with powder coating, in colour RAL 9016 as standard, in special colour or chrome on request. Delivered ready to install with matching wall brackets in colour of radiator.

### Electric operation with heating element IHC

Heating element IHC with integrated control function and modular control concept. Basic functions can be set directly on the heating element. For an even more comfortable and easy control, remote control EASY (RCE, available as accessory) or the Zehnder Connect app can be used. Control unit colour in either white, grey or black, depending on radiator colour, built-in on right collector tube. Connection cable an plug in radiator colour, protection class IP54.

### Electric operation with heating element IHE

Heating element IHE (without control function) for application in combination with on-site control (e. g. BMS systems). Control unit colour either white or chrome, depending on radiator colour, built-in on right collector tube. Connection cable with Schuko plug in white or grey, protection class IP65.

### Electric operation with heating element RACY-S

Heating element RACY-S, degree of protection IP44 (splash-proof), with Euro plug, seamlessly integrated into the frame profile on the bottom right. Separate, battery-operated remote control device model 2 for controlling the room temperature.

## Zehnder Metropolitan Spa

### Overview of models

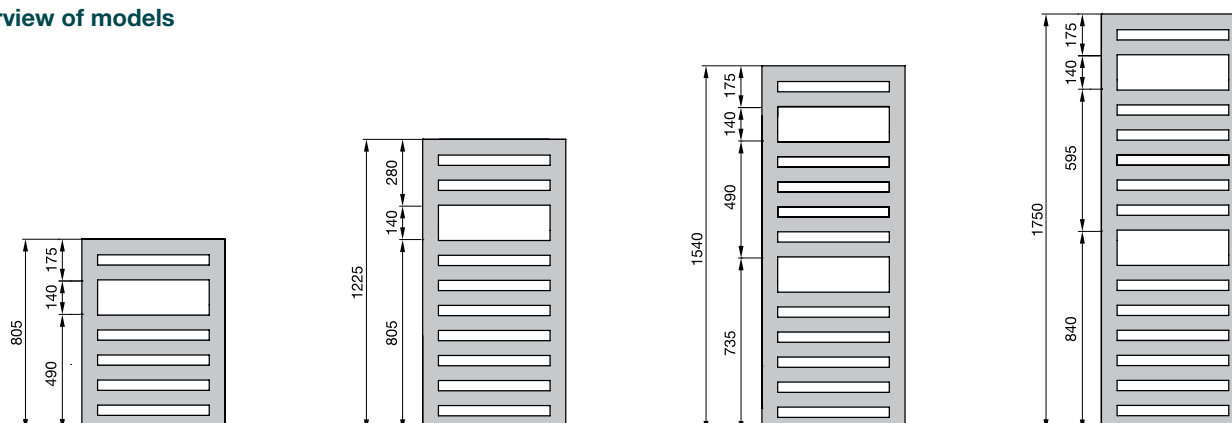

### Connection to hot water central heating system

Model	H mm	L mm	Thermal output				Exp. n	Classification Electric heating element Watt	V dm <sup>3</sup>	M kg	Price RAL 9016 €	Price <sup>Ⓞ</sup> Cat. 1 €
			EN 442 <sup>Ⓞ</sup> W	70/55/24 W	55/45/24 W	55/45/20 W						
<b>Painted version</b>												
<b>MET-080-040</b>	805	400	327	233	143	171	1,25	-	3,5	6,5	<b>708,23</b>	<b>885,28</b>
<b>MET-120-040</b>	1225	400	474	337	206	247	1,26	-	4,8	9,8	<b>785,05</b>	<b>981,32</b>
<b>MET-150-040</b>	1540	400	582	414	252	303	1,26	-	5,4	11,5	<b>928,37</b>	<b>1.160,46</b>
<b>MET-180-040</b>	1750	400	654	466	285	343	1,25	-	6,5	13,7	<b>1.037,60</b>	<b>1.297,01</b>
<b>MET-080-050</b>	805	500	388	276	168	202	1,26	-	3,8	7,8	<b>721,90</b>	<b>902,38</b>
<b>MET-120-050</b>	1225	500	561	399	243	293	1,26	-	5,2	11,7	<b>802,11</b>	<b>1.002,65</b>
<b>MET-150-050</b>	1540	500	690	489	297	358	1,27	-	5,9	13,5	<b>947,15</b>	<b>1.183,95</b>
<b>MET-180-050</b>	1750	500	775	551	336	404	1,26	-	7,3	16,3	<b>1.059,80</b>	<b>1.324,76</b>
<b>MET-080-060</b>	805	600	445	315	192	231	1,27	-	4,2	9,1	<b>745,81</b>	<b>932,26</b>
<b>MET-120-060</b>	1225	600	645	457	278	335	1,27	-	5,7	13,5	<b>827,70</b>	<b>1.034,62</b>
<b>MET-150-060</b>	1540	600	792	560	339	409	1,28	-	6,5	15,6	<b>976,16</b>	<b>1.220,20</b>
<b>MET-180-060</b>	1750	600	889	630	383	461	1,27	-	8,0	19,0	<b>1.092,23</b>	<b>1.365,29</b>

### Connection for dual energy operation with integrated electric heating element<sup>1)</sup>



Model	H mm	L mm	Thermal output				Exp. n	Classification Electric heating element Watt	V dm <sup>3</sup>	M kg	Price RAL 9016 €	Price <sup>Ⓞ</sup> Cat. 1 €
			EN 442 <sup>Ⓞ</sup> W	70/55/24 W	55/45/24 W	55/45/20 W						
<b>Painted version</b>												
<b>METM-120-050/GD</b>	1225	500	561	399	243	293	1,26	500	5,1	12,2	<b>1.305,76</b>	<b>1.501,63</b>
<b>METM-150-050/GD</b>	1540	500	690	489	297	358	1,27	600	5,8	14,0	<b>1.462,72</b>	<b>1.682,12</b>
<b>METM-180-050/GD</b>	1750	500	775	551	336	404	1,26	750	7,1	16,8	<b>1.566,21</b>	<b>1.801,15</b>
<b>METM-180-060/GD</b>	1750	600	889	630	383	461	1,27	900	7,8	19,5	<b>1.614,51</b>	<b>1.856,70</b>

<sup>1)</sup> Maximum operating pressure for dual energy operation is 4 bar

<sup>Ⓞ</sup> For special colours in categories 1 and 2, see "Special solutions" and "Colour chart"

<sup>Ⓞ</sup> Thermal output to EN 442, ΔT 50 K (75/65/20°C)

<sup>Ⓞ</sup> For Completo version (with integrated valve), note greater height; total height H<sub>T</sub> = H + 175 mm

For legend, see "Electric operation and Ecodesign Directive" on page 166

## Zehnder Metropolitan Spa

### Connection for dual energy operation with new electric platform, heating element IHC



Model	H mm	L mm	Thermal output				Exp. n	Classification Electric heating element Watt	V dm <sup>3</sup>	M kg	Price RAL 9016 €	Price <sup>①</sup> Cat. 1 €
			EN 442 <sup>②</sup> W	70/55/24 W	55/45/24 W	55/45/20 W						
<b>METSS120050MCZD</b>	1225	500	561	399	243	293	1,26	500	5,1	12,2	<b>1.179,32</b>	<b>1.399,92</b>
<b>METSS150050MCZD</b>	1540	500	690	489	297	358	1,27	600	5,8	14,0	<b>1.338,87</b>	<b>1.599,35</b>
<b>METSS180050MCZD</b>	1750	500	775	551	336	404	1,26	750	7,1	16,8	<b>1.468,28</b>	<b>1.759,74</b>
<b>METSS180060MCZD</b>	1750	600	889	630	383	461	1,27	900	7,8	19,5	<b>1.503,95</b>	<b>1.804,32</b>

### Electric-only operation



Model	H mm	L mm	Classification Electric heating element Watt	Price RAL 9016 €	Price <sup>①</sup> Cat. 1 €
-------	---------	---------	---	------------------------	-----------------------------------

Painted version					
<b>METE-080-040/GD</b>	805	400	300	<b>1.174,13</b>	<b>1.350,25</b>
<b>METE-150-040/GD</b>	1540	400	500	<b>1.443,76</b>	<b>1.660,33</b>
<b>METE-180-040/GD</b>	1750	400	600	<b>1.546,17</b>	<b>1.778,10</b>
<b>METE-120-050/GD</b>	1225	500	500	<b>1.315,78</b>	<b>1.513,14</b>
<b>METE-150-050/GD</b>	1540	500	600	<b>1.474,48</b>	<b>1.695,65</b>
<b>METE-180-050/GD</b>	1750	500	750	<b>1.578,62</b>	<b>1.815,40</b>
<b>METE-180-060/GD</b>	1750	600	900	<b>1.628,04</b>	<b>1.872,26</b>

### Electric-only operation with new electric platform



Model	H <sup>③</sup> mm	L mm	Classification Electric heating element Watt	Price RAL 9016 €		Price Cat. 1 <sup>①</sup> €	
				Heating element IHC (C)	Heating element IHE (A)	Heating element IHC (C)	Heating element IHE (A)

Painted version							
<b>METSS080040E_ZD</b>	805	400	300	<b>1.113,46</b>	<b>871,42</b>	<b>1.317,07</b>	<b>1.078,31</b>
<b>METSS150040E_ZD</b>	1540	400	600	<b>1.378,13</b>	<b>1.118,74</b>	<b>1.645,03</b>	<b>1.386,51</b>
<b>METSS180040E_ZD</b>	1750	400	600	<b>1.503,74</b>	<b>1.238,90</b>	<b>1.802,06</b>	<b>1.536,71</b>
<b>METSS120050E_ZD</b>	1225	500	600	<b>1.232,93</b>	<b>979,86</b>	<b>1.463,55</b>	<b>1.212,92</b>
<b>METSS150050E_ZD</b>	1540	500	600	<b>1.399,72</b>	<b>1.139,40</b>	<b>1.672,04</b>	<b>1.412,35</b>
<b>METSS180050E_ZD</b>	1750	500	900	<b>1.535,02</b>	<b>1.273,48</b>	<b>1.839,72</b>	<b>1.578,24</b>
<b>METSS180060E_ZD</b>	1750	600	900	<b>1.572,31</b>	<b>1.330,15</b>	<b>1.886,33</b>	<b>1.644,82</b>

#### Standard scope of delivery for operation on hot water central heating system

- Powder coating to DIN 55900, RAL 9016
- 4 x ½" connections for flow, return
- Completo: Pre-adjustable valve AV 9, chrome thermostat, connections: 2 x ¾" external thread (at the back)
- Dual energy operation: Electric heating element RACY-S, pre-assembled on the right, with remote control device, incl. batteries, selectable operating modes: manual (above room temperature), weekly programme, timer, off
- ½" chrome directional air vent
- Mounting accessories in colour of radiator
- Packaging

#### Standard scope of delivery for electric operation

- Powder coating to DIN 55900, RAL 9016
- Filled with non-flammable heat-transfer fluid (frost-proof to -10°C)
- Mounting accessories in colour of radiator
- Packaging
- Version with heating element IHC: With built-in immersion heater in outer manifold and control unit with LED matrix display, control unit white, black or grey (depending on radiator colour), cable and plug in colour of control unit
- Version with heating element IHE: With built-in immersion heater in outer manifold, without control option, control unit in white (if radiator is white) or chrome (for all other radiator surfaces).
- Version with integrated heating element RACY-S: with remote control device, incl. battery, with selectable operating modes: manual (above room temperature), weekly programme, timer, off.

① For special colours in categories 1 and 2, see "Special solutions" and "Colour chart"

② Thermal output to EN 442, ΔT 50 K (75/65/20°C)

③ Total height w/o heating element. For IHC +128 mm, for IHE +50 mm.

For legend, see "Electric operation and Ecodesign Directive" on page 166

# Zehnder Metropolitan Spa

Special solution on request (surcharge)	Article number	Price €
▪ Special finish to category 2 (surcharge on cat. 1)	<b>M100011640</b>	<b>146,76</b>
▪ Special finish in Technoline (surcharge on cat. 1)	<b>See colour chart</b>	<b>As in Cat. 2</b>
▪ Remote control EASY for IHC (RCE)*	<b>887970</b>	<b>133,38</b>
▪ Surface in metal look: stainless-steel look (reduced output approx. 8%)	<b>M100012332</b>	<b>As in Cat. 1</b>
▪ Integrated valve including thermostat; note greater height (HT = H + 175 mm, see drawing)	-	<b>361,19</b>
▪ Side connection (both left or right); any connection size	-	<b>190,99</b>
▪ Towel hook, for attaching, set of 2, chrome	<b>480438</b>	<b>57,04</b>
▪ Towel rail for hanging towels on the side, for radiators of length 400, chrome	<b>468038</b>	<b>156,06</b>
▪ Towel rail for hanging towels on the side, for radiators of length 500, chrome	<b>468048</b>	<b>156,06</b>
▪ Towel rail for hanging towels, for radiators of length 600, chrome	<b>468058</b>	<b>156,06</b>
▪ Towel rail for hanging towels, for radiators of length 900, chrome	<b>468078</b>	<b>186,16</b>
▪ Zehnder thermostat SH, M 30 x 1,5, white or chrome	-	<b>See page 158</b>
▪ Zehnder valves, lockshield valves and connection fittings	-	<b>See p. 159 onwards</b>

### Operation on hot water central heating system:

Wall mounting

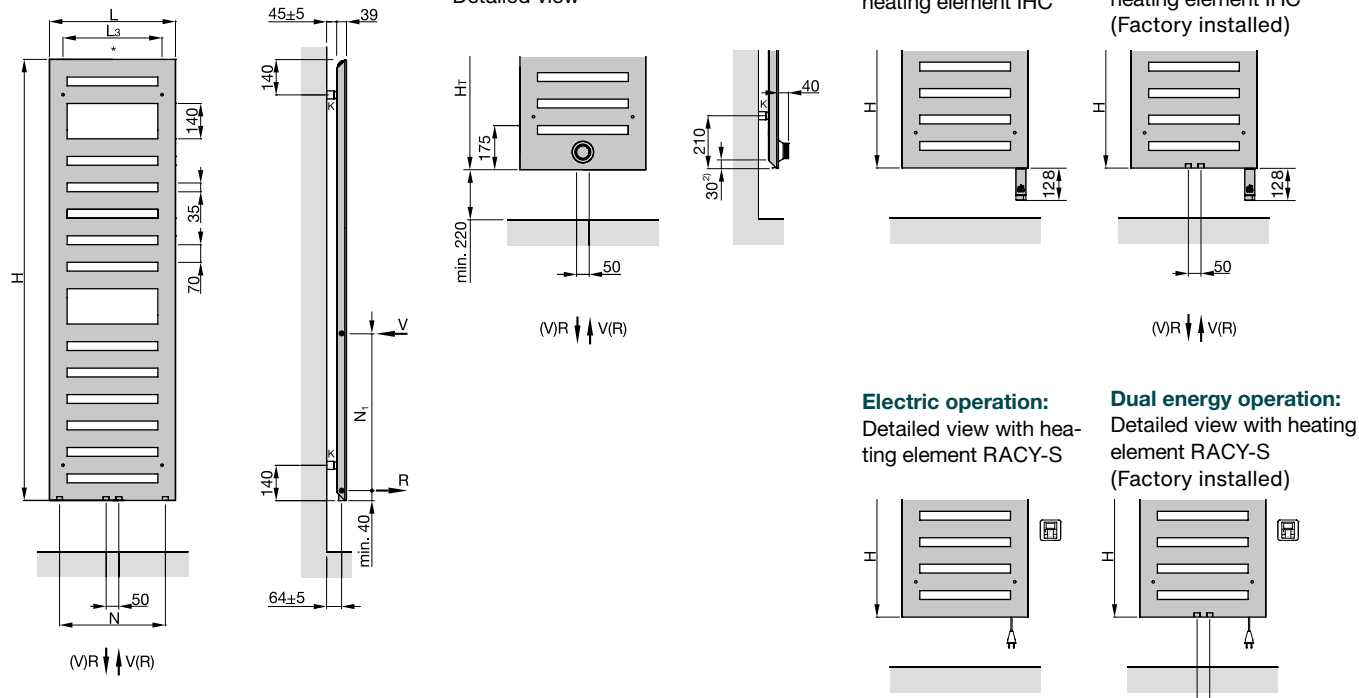

- H = Height
- L = Length
- L<sub>3</sub> = Fixing dimension, L - 106 mm
- K = Bracket
- V = Flow 1/2"
- R = Return 1/2"
- \* = Venting 1/2"
- N = Connection centre, L - 80 mm
- N<sub>1</sub> = Connection centre for side connection
- H<sub>T</sub> = Total height, H + 175 mm

Dimensions in mm

1) Without internal by-pass for single-tube operation, not possible with dual energy operation  
 2) Distance from bottom edge of radiator to middle of connection

Ⓞ For special colours in categories 1 and 2, see "Special solutions" and "Colour chart"  
 For legend, see "Electric operation and Ecodesign Directive" on page 166

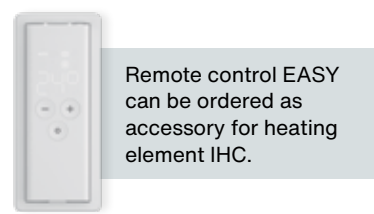

## Zehnder Metropolitan Bar



Radiator colour: Traffic White



### Operation on hot water central heating system

Zehnder Metropolitan Bar decorative radiator for use as a bathroom and towel radiator. Flat-looking radiator with recessed slots, made from horizontally arranged flat tubes 70 x 8 mm, which are connected with a surrounding triangular profile frame without visible welded joints. With even structure incl. towel rail. Thermal output to EN 442; with CE marking. With 4 connections at bottom, 2 x central 1/2" for flow/return, spacing 50 mm and 2 x 1/2", outside left and right, with directional air vent.

Connections for Completto version: Flow/return 2 x 3/4" external thread at the back, centred 50 mm spacing, including valve and thermostat integrated into front panel.

Connections for dual energy operation: Flow/return 2 x 1/2" at bottom centre, spacing 50 mm and factory covered integrated electric heating element RACY-S, bottom right, with separate remote control device model 2.

Radiator with powder coating, in colour RAL 9016 as standard, in special colour on request. Delivered ready to install with matching wall brackets and packaging.

Operating pressure	max. 4,0 bar
Hot water central heating system operating temperature	max. 110°C
Dual energy operation operating temperature (model MEPM)	max. 95°C
Height	..... mm
Length	..... mm
Model	.....

### Benefits

- Innovative radiator with flat design
- Clean look due to innovative welding technology
- Model with towel rail for easy hanging of towels
- Individually positionable designer towel hook
- Elegant solutions for valve integration on request
- Dual energy operation: electric heating element RACY-S integrated elegantly
- Side connections for easy replacement of old DIN standard radiators on request

### Electric operation

Zehnder Metropolitan Bar decorative radiator, electric-only, for use as a bathroom and towel radiator. Flat-looking radiator with recessed slots, made from horizontally arranged flat tubes 70 x 8 mm, which are connected with a surrounding triangular profile frame without visible welded joints. With even structure incl. towel rail.

Electric version filled with heat transfer fluid, for connection to 230 V mains supply. With 1,2 m connection cable. Radiator with powder coating, in colour RAL 9016 as standard, in special colour or chrome on request. Delivered ready to install with matching wall brackets in colour of radiator.

### Electric operation with heating element IHC

Heating element IHC with integrated control function and modular control concept. Basic functions can be set directly on the heating element. For an even more comfortable and easy control, remote control EASY (RCE, available as accessory) or the Zehnder Connect app can be used. Control unit colour in either white, grey or black, depending on radiator colour, built-in on right collector tube. Connection cable an plug in radiator colour, protection class IP54.

### Electric operation with heating element IHE

Heating element IHE (without control function) for application in combination with on-site control (e. g. BMS systems). Control unit colour either white or chrome, depending on radiator colour, built-in on right collector tube. Connection cable with Schuko plug in white or grey, protection class IP65.

### Electric operation with heating element RACY-S

Heating element RACY-S, degree of protection IP44 (splash-proof), with Euro plug, seamlessly integrated into the frame profile on the bottom right. Separate, battery-operated remote control device model 2 for controlling the room temperature.

## Zehnder Metropolitan Bar

### Overview of models

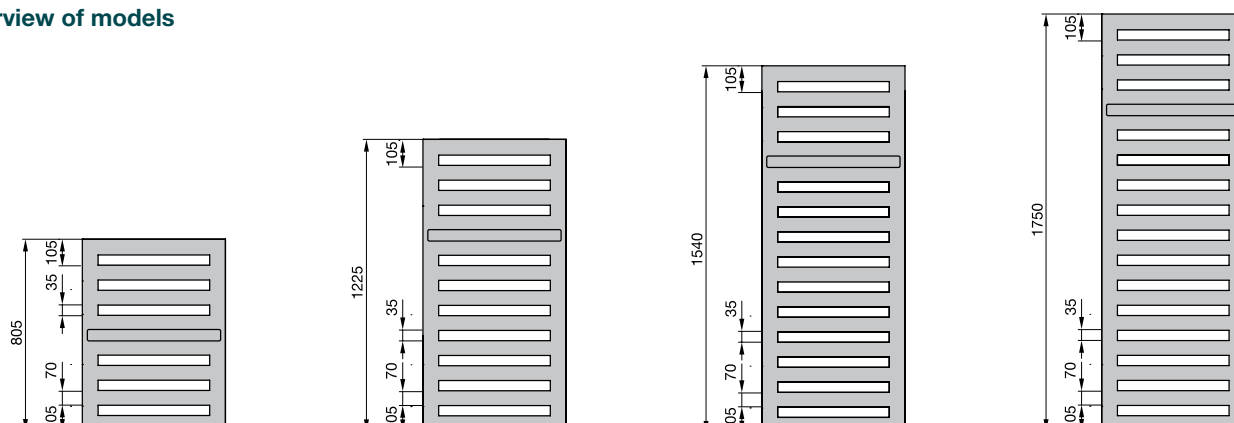

### Connection to hot water central heating system

Model	H <sup>ⓐ</sup> mm	L mm	Thermal output				Exp. n	Classification Electric heating element Watt	V dm <sup>3</sup>	M kg	Price RAL 9016 €	Price <sup>ⓑ</sup> Cat. 1 €
			EN 442 <sup>ⓐ</sup> W	70/55/24 W	55/45/24 W	55/45/20 W						

Painted version with chrome-plated towel rail												
MEP-080-040	805	400	323	228	137	166	1,29	-	3,5	6,8	836,22	1.045,27
MEP-120-040	1225	400	469	332	201	242	1,28	-	4,9	10,3	918,14	1.147,67
MEP-150-040	1540	400	582	418	259	310	1,22	-	5,5	12,0	1.064,92	1.331,15
MEP-180-040	1750	400	663	467	282	340	1,29	-	6,7	14,4	1.179,24	1.474,05
MEP-080-050	805	500	387	273	165	199	1,29	-	4,0	8,2	851,57	1.064,47
MEP-120-050	1225	500	563	398	241	291	1,28	-	5,5	12,4	935,21	1.169,01
MEP-150-050	1540	500	730	523	323	387	1,23	-	6,2	14,4	1.085,39	1.356,74
MEP-180-050	1750	500	795	561	338	408	1,29	-	7,6	17,4	1.201,41	1.501,76
MEP-080-060	805	600	449	317	191	231	1,29	-	4,4	9,7	875,46	1.094,32
MEP-120-060	1225	600	653	462	279	337	1,28	-	6,1	14,5	960,79	1.201,00
MEP-150-060	1540	600	871	624	385	461	1,23	-	7,0	16,8	1.116,10	1.395,12
MEP-180-060	1750	600	922	650	392	473	1,29	-	8,5	20,4	1.235,57	1.544,46

Model	H mm	L mm	Thermal output				Exp. n	Classification Electric heating element Watt	V dm <sup>3</sup>	M kg	Price RAL 9016 €	Price <sup>ⓑ</sup> Cat. 1 €
			EN 442 <sup>ⓐ</sup> W	70/55/24 W	55/45/24 W	55/45/20 W						

Painted version with chrome-plated towel rail for installation below windows												
MEP-060-090	595	900	447	314	189	228	1,30	-	4,7	10,1	930,10	1.162,61
MEP-070-090	700	900	517	364	218	264	1,30	-	5,2	11,8	950,57	1.188,20

### Connection for dual energy operation with integrated electric heating element\*



Model	H mm	L mm	Thermal output				Exp. n	Classification Electric heating element Watt	V dm <sup>3</sup>	M kg	Price RAL 9016 €	Price <sup>ⓑ</sup> Cat. 1 €
			EN 442 <sup>ⓐ</sup> W	70/55/24 W	55/45/24 W	55/45/20 W						

Painted version with chrome-plated towel rail												
MEPM-120-050/GD	1225	500	563	398	241	291	1,28	500	5,4	13,3	1.467,90	1.688,07
MEPM-150-050/GD	1540	500	730	523	323	387	1,23	600	6,1	15,4	1.631,76	1.876,53
MEPM-180-050/GD	1750	500	795	561	338	408	1,29	750	7,5	18,3	1.740,42	2.001,49
MEPM-180-060/GD	1750	600	922	650	392	473	1,29	900	8,4	21,4	1.790,47	2.059,04

\* Maximum operating pressure for dual energy operation is 4 bar

ⓐ For special colours in categories 1 and 2, see "Special solutions" and "Colour chart"

ⓑ Thermal output to EN 442, ΔT 50 K (75/65/20°C)

ⓐ For Completto version (with integrated valve), note greater height; total height H<sub>T</sub> = H + 175 mm

For legend, see "Electric operation and Ecodesign Directive" on page 166

## Zehnder Metropolitan Bar

### Connection for dual energy operation with new electric platform, heating element IHC



Model	H <sup>②</sup> mm	L mm	Thermal output				Exp. n	Classification Electric heating element Watt	V dm <sup>3</sup>	M kg	Price RAL 9016 €	Price <sup>①</sup> Cat. 1 €
			EN 442 <sup>③</sup> W	70/55/24 W	55/45/24 W	55/45/20 W						

#### Painted version

MEPSS120050MCZD	1225	500	563	398	241	291	1,28	500	5,4	13,3	1.325,73	1.582,91
MEPSS150050MCZD	1540	500	730	523	323	387	1,23	600	6,1	15,4	1.490,93	1.789,41
MEPSS180050MCZD	1750	500	795	561	338	408	1,29	750	7,5	18,3	1.624,05	1.954,44
MEPSS180060MCZD	1750	600	922	650	392	473	1,29	900	8,4	21,4	1.661,63	2.001,41



### Electric-only operation

Model	H mm	L mm	Classification Electric heating element Watt	Price RAL 9016 €	Price <sup>①</sup> Cat. 1 €
-------	---------	---------	---	------------------------	-----------------------------------

#### Painted version with chrome-plated towel rail

MEPE-080-040/GD	805	400	300	1.314,07	1.511,18
MEPE-150-040/GD	1540	400	500	1.622,91	1.866,35
MEPE-180-040/GD	1750	400	600	1.718,51	1.976,30
MEPE-120-050/GD	1225	500	500	1.476,19	1.697,61
MEPE-150-050/GD	1540	500	600	1.641,73	1.887,98
MEPE-180-050/GD	1750	500	750	1.750,95	2.013,59
MEPE-180-060/GD	1750	600	900	1.802,17	2.072,49



### Electric-only operation with new electric platform

Model	H <sup>②</sup> mm	L mm	Classification Electric heating element Watt	Price RAL 9016 €		Price Cat. 1 <sup>①</sup> €	
				Heating element IHC (C)	Heating element IHE (A)	Heating element IHC (C)	Heating element IHE (A)

#### Painted version

MEPSS080040E_ZD	805	400	300	1.260,65	1.012,21	1.501,06	1.254,30
MEPSS150040E_ZD	1540	400	600	1.535,16	1.268,95	1.841,32	1.574,27
MEPSS180040E_ZD	1750	400	600	1.666,63	1.394,70	2.005,66	1.731,46
MEPSS120050E_ZD	1225	500	600	1.385,99	1.126,27	1.654,86	1.395,91
MEPSS150050E_ZD	1540	500	600	1.558,70	1.291,47	1.870,75	1.602,41
MEPSS180050E_ZD	1750	500	900	1.697,87	1.429,25	2.043,27	1.772,94
MEPSS180060E_ZD	1750	600	900	1.737,16	1.487,83	2.092,38	1.841,91

① For special colours in categories 1 and 2, see "Special solutions" and "Colour chart"

② Thermal output to EN 442, ΔT 50 K (75/65/20°C)

③ Total height w/o heating element. For IHC +128 mm, for IHE +50 mm.

For legend, see "Electric operation and Ecodesign Directive" on page 166

## Zehnder Metropolitan Bar

### Standard scope of delivery for operation on hot water central heating system

- Powder coating to DIN 55900, RAL 9016
- 4 x ½" connections for flow, return
- Completo: Pre-adjustable valve AV 9, chrome thermostat, connections: 2 x ¾" external thread (at the back)
- Dual energy operation: Electric heating element RACY-S, pre-assembled on the right, with remote control device, incl. batteries, selectable operating modes: manual (above room temperature), weekly programme, timer, off
- ½" chrome directional air vent
- Towel rail in chrome
- Mounting accessories in colour of radiator
- Packaging

### Standard scope of delivery for electric operation

- Powder coating to DIN 55900, RAL 9016
- Filled with heat transfer fluid
- Towel rail in chrome
- Mounting accessories in colour of radiator
- Packaging
- Version with heating element IHC: With built-in immersion heater in outer manifold and control unit with LED matrix display, control unit white, black or grey (depending on radiator colour), cable and plug in colour of control unit
- Version with heating element IHE: With built-in immersion heater in outer manifold, without control option, control unit in white (if radiator is white) or chrome (for all other radiator surfaces).
- Version with integrated heating element RACY-S: with remote control device, incl. battery, with selectable operating modes: manual (above room temperature), weekly programme, timer, off.

Special solution on request (surcharge)	Article number	Price €
▪ Special finish to category 2 (surcharge on cat. 1)	M100011640	146,76
▪ Special finish in Technoline (surcharge on cat. 1)	See colour chart	As in Cat. 2
▪ Remote control EASY for IHC (RCE)*	887970	133,38
▪ Surface in metal look: stainless-steel look (reduced output approx. 8%)	M100012332	As in Cat. 1
▪ Integrated valve including thermostat; note greater height (HT = H + 175 mm, see drawing)	-	361,19
▪ Side connection (both left or right); any connection size	-	190,99
▪ Towel hook, for attaching, set of 2, chrome	480438	57,04
▪ Towel rail for hanging towels on the side (295 mm in length), for radiators of length 400, chrome	468038	156,06
▪ Towel rail for hanging towels on the side (395 mm in length), for radiators of length 500, chrome	468048	156,06
▪ Towel rail for hanging towels (495 mm in length), for radiators of length 600, chrome	468058	156,06
▪ Towel rail for hanging towels (795 mm in length), for radiators of length 900, chrome	468078	186,16
▪ Zehnder thermostat SH, M 30 x 1,5, white	819080	38,09
▪ Zehnder thermostat SH, M 30 x 1,5, chrome	819088	53,47
▪ Zehnder valves, lockshield valves and connection fittings	-	See p. 159 onwards



Remote control EASY can be ordered as accessory for heating element IHC.

# Zehnder Metropolitan Bar

**Operation on hot water central heating system:**  
Wall mounting

Integrated valve (Completo)<sup>1)</sup>

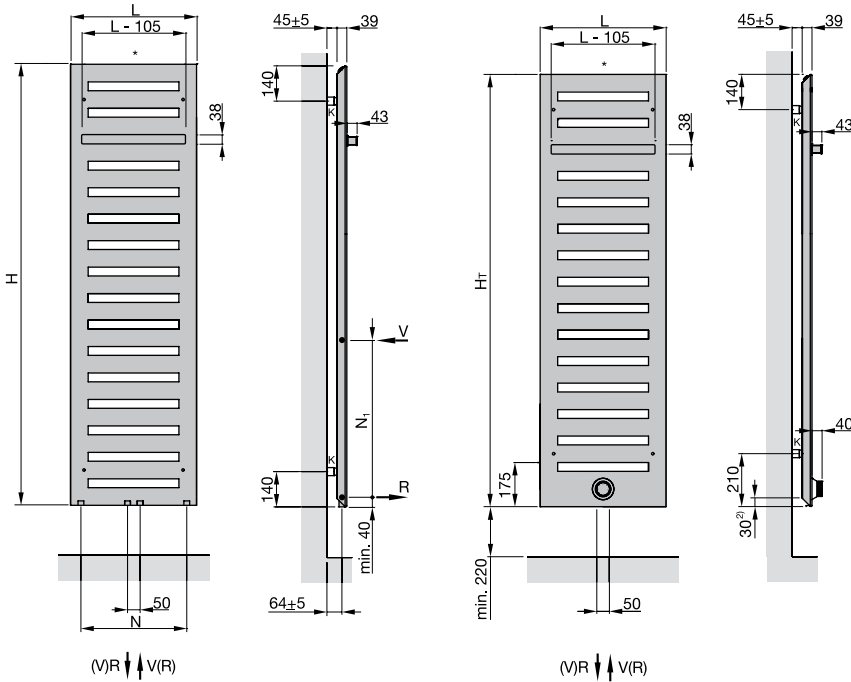

**Electric operation:**  
with heating element IHC

**Dual energy operation:**  
with heating element IHC  
(Factory installed)

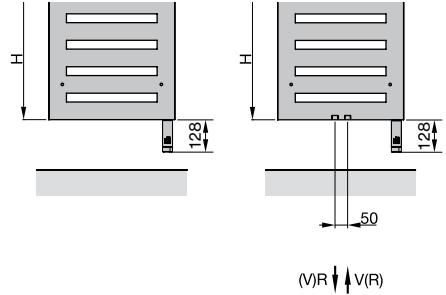

**Electric operation:**  
with heating element RACY-S

**Dual energy operation:**  
with heating element RACY-S  
(Factory installed)

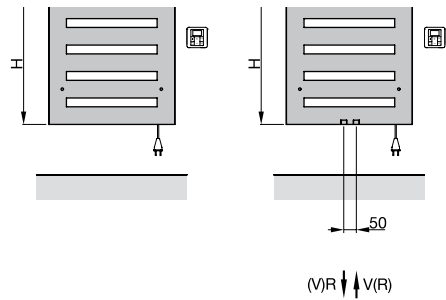

**Operation on hot water central heating system:**  
Version for installation below windows

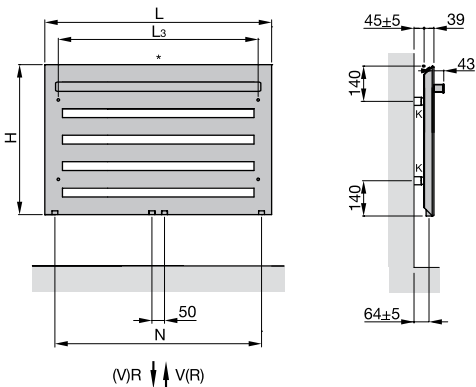

- H = Height
- L = Length
- L<sub>3</sub> = Fixing dimension, L - 106 mm
- K = Bracket
- V = Flow 1/2"
- R = Return 1/2"
- \* = Venting 1/2"
- N = Connection centre, L - 80 mm
- N<sub>1</sub> = Connection centre for side connection
- H<sub>T</sub> = Total height, H + 175 mm

Dimensions in mm

- 1) Without internal by-pass for single-tube operation, not possible with dual energy operation
- 2) Distance from bottom edge of radiator to middle of connection

## Zehnder Kazeane



Radiator colour: Black Matt



Radiator top with IHC / Radiator bottom with RACY-C

### Operation on hot water central heating system

Zehnder Kazeane decorative radiator made from vertically arranged D-profile tubes rounded at the outside, 30 x 40 mm, plus offset and diagonally arranged flat tubes, 70 x 8 mm, which wrap around the bathroom radiator like a steel band. The resulting generous cut-outs on two levels create space for hanging several towels. Additionally, one or two horizontal flat tubes, depending on height. D-profile tubes arranged at the top and side, plus square tube, 30 x 30 mm, at bottom create a functional mounting plate.

Thermal output to EN 442, with CE marking. With 4 connections at bottom, 2 x central 1/2" for flow/return, spacing 50 mm and 2 x 1/2", outside left and right, with directional air vent.

Radiator with powder coating, in colour RAL 9016 as standard, in special colour on request. Delivered ready to install with matching wall brackets and packaging.

Operating pressure	max. 4.0 bar
Operating temperature	max. 110 °C
Height	..... mm
Length	..... mm
Model	.....

### Benefits

- Individuality through exceptional design
- Many different heights at which to hang a towel
- The arrangement of the flat tubes on two levels makes it easier to hang multiple towels – ideal for families
- Inconspicuous brackets concealed behind header tube
- Ample spaces between tubes make cleaning easy

### Electric operation

Zehnder Kazeane decorative radiator, electric-only, made from vertically arranged D-profile tubes rounded at the outside, 30 x 40 mm, plus offset and diagonally arranged flat tubes, 70 x 8 mm, which wrap around the bathroom radiator like a steel band. The resulting generous cut-outs on two levels create space for hanging several towels. Also features one horizontal flat tube. D-profile tubes arranged at the top and side, plus square tube, 30 x 30 mm, at bottom create a functional mounting plate. Radiator with powder coating, in colour RAL 9016 as standard, in special colour or chrome-plated. Delivered ready to install with matching wall brackets and packaging.

### Electric operation with heating element IHC

Heating element IHC with integrated control function and modular control concept. Basic functions can be set directly on the heating element. For an even more comfortable and easy control, remote control EASY (RCE, available as accessory) or the Zehnder Connect app can be used. Control unit colour in either white, grey or black, depending on radiator colour, built-in on right collector tube. Connection cable and plug in radiator colour, protection class IP54.

### Electric operation with heating element IHE

Heating element IHE (without control function) for application in combination with on-site control (e. g. BMS systems). Control unit colour either white or chrome, depending on radiator colour, built-in on right collector tube. Connection cable with Schuko plug in white or grey, protection class IP65.

### Electric operation with heating element RACY-C

Heating element RACY-C, degree of protection IP44 (splash-proof), with Euro plug, installation at bottom left., cover in radiator colour. Separate, battery-operated remote control device model 2 for controlling the room temperature.

# Zehnder Kazeane

## Overview of models

### Length 500

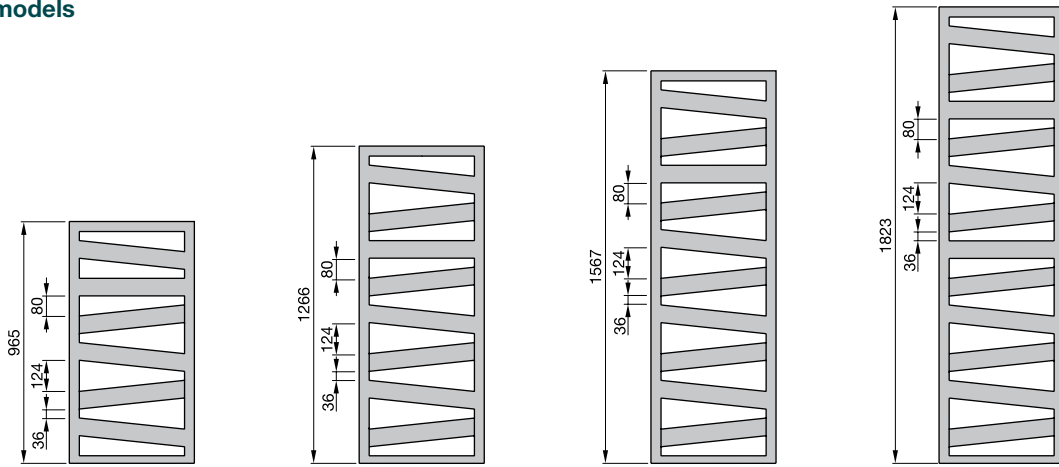

## Overview of models

### Length 600

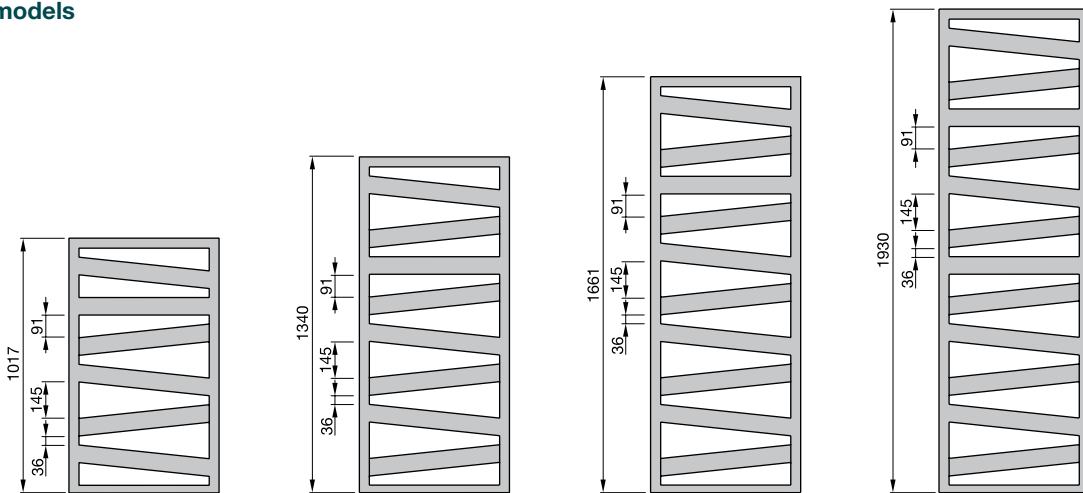

## Zehnder Kazeane

### Connection to hot water central heating system

Model	H mm	L mm	Thermal output				Exp. n	Classification Electric heating element Watt	V dm <sup>3</sup>	M kg	Price RAL 9016 €	Price <sup>①</sup> Cat. 1 €
			EN 442 <sup>②</sup> W	70/55/24 W	55/45/24 W	55/45/20 W						

#### Painted version

RK-100-050	965	500	398	284	175	210	1,24	300	3,4	8,4	337,09	421,36
RK-130-050	1266	500	509	364	224	268	1,24	300	4,1	10,7	403,29	504,11
RK-160-050	1567	500	621	445	275	329	1,23	600	4,8	13,1	468,97	575,93
RK-180-050	1823	500	723	515	316	379	1,25	600	5,7	15,1	517,93	647,42
RK-100-060	1017	600	473	337	206	248	1,25	300	3,8	9,9	380,75	475,93
RK-130-060	1340	600	608	435	267	320	1,24	600	4,6	12,6	453,13	566,41
RK-170-060	1661	600	743	531	327	391	1,24	600	5,4	15,4	534,53	657,38
RK-190-060	1930	600	847	604	370	444	1,25	600	6,5	18,0	587,90	734,87

Model	H mm	L mm	Thermal output				Exp. n	Classification Electric heating element Watt	V dm <sup>3</sup>	M kg	Price Chrome €
			EN 442 <sup>②</sup> W	70/55/24 W	55/45/24 W	55/45/20 W					

#### Chrome-plated version

RKC-100-050	965	500	261	187	114	137	1,27	-	3,4	8,5	1.334,79
RKC-130-050	1266	500	327	235	142	171	1,27	300	4,1	10,8	1.485,05
RKC-160-050	1567	500	393	282	171	205	1,28	300	4,8	13,1	1.730,12
RKC-180-050	1823	500	461	330	199	240	1,28	300	5,7	15,4	1.959,16
RKC-100-060	1017	600	304	218	132	158	1,28	300	3,8	10,0	1.377,10
RKC-130-060	1340	600	386	277	168	201	1,27	300	4,6	12,7	1.590,07
RKC-170-060	1661	600	468	336	204	245	1,27	300	5,4	15,4	1.805,99
RKC-190-060	1930	600	544	390	236	283	1,28	300	6,5	17,9	2.020,42



### Electric-only operation with new electric platform

Model	H* mm	L mm	Classification Electric heating element Watt	Price RAL 9016 €		Price Cat. 1 <sup>①</sup> €	
				Heating element IHC (C)	Heating element IHE (A)	Heating element IHC (C)	Heating element IHE (A)

#### Painted version

RKZSS130050E_ZD	1266	500	500	840,85	578,38	1.051,07	722,97
RKZSS160050E_ZD	1567	500	600	919,52	647,38	1.149,40	809,22
RKZSS130060E_ZD	1340	600	600	914,88	643,74	1.143,60	804,68
RKZSS170060E_ZD	1661	600	750	991,01	726,57	1.238,76	908,21

Model	H* mm	L mm	Classification Electric heating element Watt	Price Chrome €	
				Heating element IHC (C)	Heating element IHE

#### Chrome-plated version

RKZCS130050E_ZD	1266	500	300	2.059,81	1.914,54
RKZCS160050E_ZD	1567	500	300	2.357,41	2.212,14
RKZCS130060E_ZD	1340	600	300	2.390,97	2.245,70
RKZCS170060E_ZD	1661	600	500	2.802,34	2.657,07

\*Total height w/o heating element. For IHC +128 mm, for IHE +50 mm.

① For special colours in categories 1 and 2, see “Special solutions” and “Colour chart”

② Thermal output to EN 442, ΔT 50 K (75/65/20°C)

For legend, see “Electric operation and Ecodesign Directive” on page 166

## Zehnder Kazeane



### Electric-only operation

Model	H	L	Classification Electric heating element Watt	Price RAL 9016 €	Price <sup>①</sup> Cat. 1 €
-------	---	---	---	------------------------	-----------------------------------

Painted version					
RK-130-050/GD	1291	500	500	840,85	1.051,07
RK-160-050/GD	1592	500	600	933,66	1.167,08
RK-130-060/GD	1365	600	600	914,88	1.143,60
RK-170-060/GD	1686	600	750	991,01	1.238,76

Model	H*	L	Classification Electric heating element Watt	Price Chrome €
-------	----	---	---	----------------------

Chrome-plated version				
RKC-130-050/GD	1291	500	300	2.059,81
RKC-160-050/GD	1592	500	300	2.357,41
RKC-130-060/GD	1365	600	300	2.390,97
RKC-170-060/GD	1686	600	500	2.802,34

\*Total height incl. electric heating element

#### Standard scope of delivery for operation on hot water central heating system

- Powder coating to DIN 55900, RAL 9016
- 4 x ½" connections for flow, return
- ½" directional air vent
- Mounting accessories in colour of radiator
- Packaging

#### Standard scope of delivery for electric operation

- Powder coating to DIN 55900, RAL 9016
- Filled with heat transfer fluid
- Mounting accessories in colour of radiator
- Packaging
- Version with heating element IHC: With built-in immersion heater in outer manifold and control unit with LED matrix display, control unit white, black or grey (depending on radiator colour), cable and plug in colour of control unit
- Version with heating element IHE: With built-in immersion heater in outer manifold, without control option, control unit in white (if radiator is white) or chrome (for all other radiator surfaces).
- Version with integrated heating element RACY-C: with remote control device, incl. battery, with selectable operating modes: manual (above room temperature), weekly programme, timer, off.

Special solution on request (surcharge)	Article number	Price €
▪ Special finish to category 2 (surcharge on cat. 1)	M100011640	146,76
▪ Remote control EASY for IHC (RCE)*	887970	133,38
▪ Surface in metal look: stainless-steel look (reduced output approx. 8%)	M100012332	As in Cat. 1
▪ Towel hook, for attaching, set of 2, chrome	480438	57,04
▪ Zehnder valves, lockshield valves and connection fittings	-	See p. 159 onwards



Remote control EASY can be ordered as accessory for heating element IHC.

① For special colours in categories 1 and 2, see "Special solutions" and "Colour chart"

③ Thermal output to EN 442, ΔT 50 K (75/65/20°C)

For legend, see "Electric operation and Ecodesign Directive" on page 166

# Zehnder Kazeane

**Operation on hot water central heating system:**  
Wall mounting

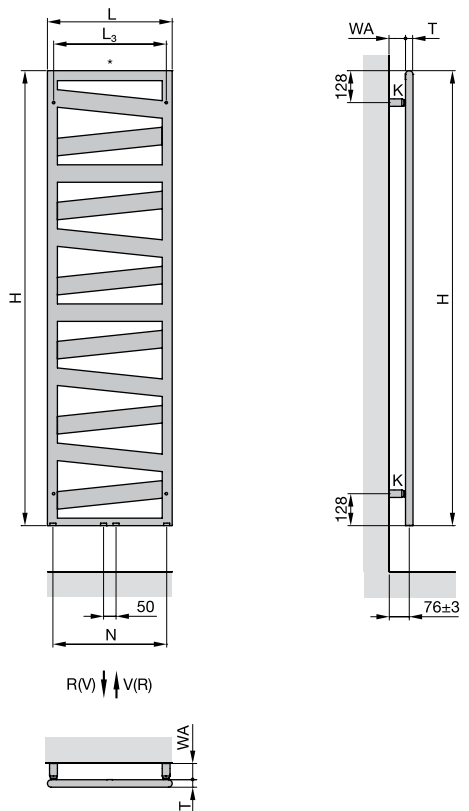

**Electric operation:**  
with heating element  
RACY-C

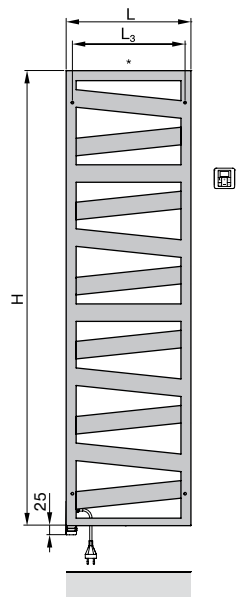

**Electric operation:**  
with heating element IHC

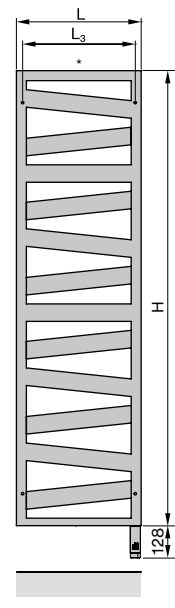

**Dual energy operation:**  
Connection to hot water central heating  
system with electric heating element  
(fig. with IHC, to be ordered separately)

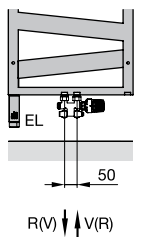

- H = Height
- L = Length
- T = Depth = 30 mm
- K = Bracket
- WA = Wall clearance = 61±3 mm
- V = Flow 1/2"
- R = Return 1/2"
- N = Connection centre, L - 44 mm
- L<sub>3</sub> = Fixing dimension, L - 49 mm

Dimensions in mm

## Zehnder Quaro



Radiator colour: Volcanic



Radiator colour: Traffic White, with heating element IHC

### Operation on hot water central heating system

Zehnder Quaro decorative radiator made from horizontally arranged precision steel tubes with surrounding square tubes, fully welded, invisible welds due to laser welding technology. Square tubes 25 x 25 mm, regularly arranged in the frame of square 30 x 30 mm tube. Thermal output tested to EN 442, with CE marking. With recessed connections on lower square tube, central 1/2" for flow/return, connection centre 50 mm and outside left and right 1/2" for electric heating element, with directional air vent. Connections for dual energy operation: Flow/return 2 x 1/2" at bottom centre, spacing 50 mm and factory integrated electric heating element RACY-S, bottom right, with separate remote control device model 2. Radiator with powder coating, in colour RAL 9016 as standard, in special colour, chrome or version in brushed V4A stainless steel on request. Delivered ready to install with matching wall brackets and packaging. Room divider version: Radiator without attachment welded at back for wall bracket, incl. room divider mounting set.

Operating pressure	max. 10.0 bar
Hot water central heating system operating temperature	max. 110 °C
Dual energy operation operating temperature (model QAM)	max. 95 °C
Height	..... mm
Length	..... mm
Model	.....

### Benefits

- Geometric clarity with consistent look
- Many different heights at which to hang a towel
- Hygienic and easy to clean
- Discreetly concealed brackets
- Also available as room divider version
- Dual energy operation: electric heating element RACY-S integrated elegantly

### Electric operation

Zehnder Quaro decorative radiator, electric-only, made from horizontally arranged precision steel tubes with surrounding square tubes, fully welded, invisible welds due to laser welding technology. Standard version with powder coating, in colour RAL 9016, special colour, chrome or version in brushed V4A stainless steel on request. Filled with heat transfer fluid. Delivered ready to install with elegant wall brackets.

### Electric operation with heating element IHC

Heating element IHC with integrated control function and modular control concept. Basic functions can be set directly on the heating element. For an even more comfortable and easy control, remote control EASY (RCE, available as accessory) or the Zehnder Connect app can be used. Control unit colour in either white, grey or black, depending on radiator colour, built-in on right collector tube. Connection cable an plug in radiator colour, protection class IP54.

### Electric operation with heating element IHE

Heating element IHE (without control function) for application in combination with on-site control (e. g. BMS systems). Control unit colour either white or chrome, depending on radiator colour, built-in on right collector tube. Connection cable with Schuko plug in white or grey, protection class IP65.

### Electric operation with heating element RACY-S

Heating element RACY-S, degree of protection IP44 (splash-proof), with Euro plug, installation at bottom left, cover in radiator colour. Separate, battery-operated remote control device model 2 for controlling the room temperature.

## Zehnder Quaro

### Overview of models

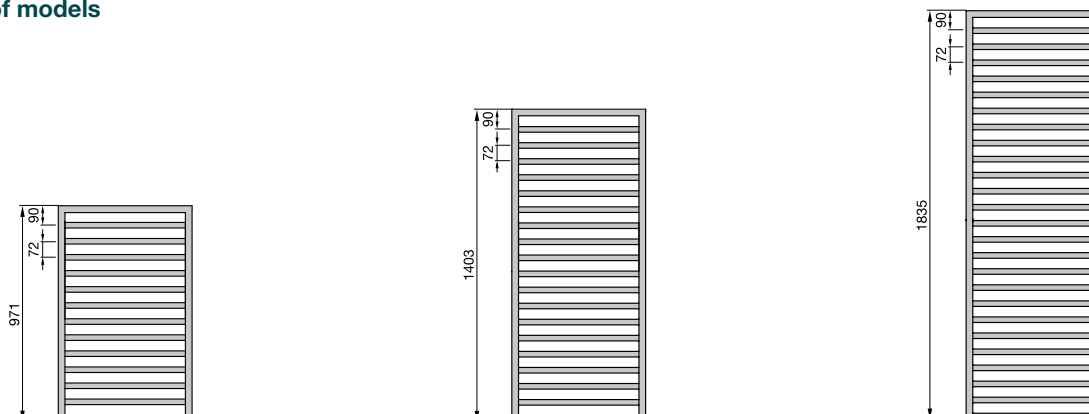

### Connection to hot water central heating system

Model	H mm	L mm	Thermal output			Exp. n	Classification Electric heating element Watt	V dm <sup>3</sup>	M kg	Price RAL 9016 €	Price <sup>①</sup> Cat. 1 €
			EN 442 <sup>②</sup> W	70/55/24 W	55/45/24 W						

#### Painted version

QA-100-030	971	300	299	214	131	158	1,24	300	3,3	5,7	<b>656,79</b>	<b>820,98</b>
QA-140-030	1403	300	421	301	185	222	1,24	300	4,7	7,9	<b>689,98</b>	<b>862,47</b>
QA-180-030	1835	300	543	389	240	288	1,23	300	6,0	10,1	<b>917,18</b>	<b>1.146,47</b>
QA-100-045	971	450	420	300	185	221	1,24	300	4,4	7,8	<b>694,94</b>	<b>868,67</b>
QA-140-045	1403	450	590	423	261	312	1,23	500	6,3	10,6	<b>729,79</b>	<b>912,24</b>
QA-180-045	1835	450	761	545	337	403	1,23	600	8,1	13,8	<b>965,27</b>	<b>1.206,60</b>
QA-100-060	971	600	533	382	236	282	1,23	300	5,5	9,8	<b>733,07</b>	<b>916,35</b>
QA-140-060	1403	600	749	537	331	397	1,23	600	7,9	13,4	<b>771,21</b>	<b>964,03</b>
QA-180-060	1835	600	966	692	427	512	1,23	900	10,2	17,0	<b>1.015,03</b>	<b>1.268,79</b>

Model	H mm	L mm	Thermal output			Exp. n	Classification Electric heating element Watt	V dm <sup>3</sup>	M kg	Price Chrome €
			EN 442 <sup>②</sup> W	70/55/24 W	55/45/24 W					

#### Chrome-plated version

QAC-100-030	971	300	189	133	80	97	1,30	-	3,3	5,8	<b>1.378,28</b>
QAC-140-030	1403	300	270	190	114	138	1,30	300	4,7	7,6	<b>1.449,58</b>
QAC-180-030	1835	300	348	245	147	178	1,30	300	6,0	10,3	<b>1.917,28</b>
QAC-100-045	971	450	267	188	114	137	1,29	300	4,4	7,9	<b>1.456,23</b>
QAC-140-045	1403	450	381	269	162	196	1,29	300	6,3	10,2	<b>1.530,86</b>
QAC-180-045	1835	450	491	345	207	252	1,29	300	8,1	13,8	<b>2.023,44</b>
QAC-100-060	971	600	341	241	146	176	1,28	300	5,5	10,0	<b>1.534,17</b>
QAC-140-060	1403	600	486	343	207	250	1,29	300	7,9	12,9	<b>1.613,77</b>
QAC-180-060	1835	600	627	442	267	322	1,29	600	10,2	17,2	<b>2.129,60</b>

① For special colours in categories 1 and 2, see "Special solutions" and "Colour chart"

② Thermal output to EN 442, ΔT 50 K (75/65/20°C)

## Zehnder Quaro

### Connection to hot water central heating system

Model	H mm	L mm	Thermal output				Exp. n	Classification Electric heating element Watt	V dm <sup>3</sup>	M kg	Price Stainless steel €
			EN 442 <sup>③</sup> W	70/55/24 W	55/45/24 W	55/45/20 W					

#### Stainless-steel version

<b>QAI-100-030</b>	971	300	229	162	99	119	1,27	-	3,3	6,0	<b>1.708,33</b>
<b>QAI-140-030</b>	1403	300	321	228	138	167	1,27	300	4,7	8,3	<b>1.799,53</b>
<b>QAI-180-030</b>	1835	300	415	294	179	215	1,27	300	6,2	10,6	<b>2.580,71</b>
<b>QAI-100-045</b>	971	450	321	228	139	167	1,26	300	4,5	7,8	<b>1.824,39</b>
<b>QAI-140-045</b>	1403	450	450	320	195	235	1,26	300	6,3	10,8	<b>1.920,60</b>
<b>QAI-180-045</b>	1835	450	581	413	252	303	1,26	300	8,1	13,8	<b>2.749,89</b>
<b>QAI-100-060</b>	971	600	407	289	176	212	1,26	300	5,7	9,6	<b>1.938,84</b>
<b>QAI-140-060</b>	1403	600	572	407	248	298	1,26	300	7,9	13,3	<b>2.040,01</b>
<b>QAI-180-060</b>	1835	600	738	525	320	385	1,26	600	10,2	17,0	<b>2.919,06</b>



### Connection for dual energy operation with integrated electric heating element

Model	H <sup>④</sup> mm	L mm	Thermal output				Exp. n	Classification Electric heating element Watt	V dm <sup>3</sup>	M kg	Price	Price <sup>①</sup>
			EN 442 <sup>③</sup> W	70/55/24 W	55/45/24 W	55/45/20 W					RAL 9016 €	Cat. 1 €

#### Painted version

<b>QAM-100-045/GD</b>	1001	450	420	300	185	222	1,23	300	4,4	7,8	<b>1.204,11</b>	<b>1.384,73</b>
<b>QAM-140-045/GD</b>	1433	450	590	423	261	312	1,23	500	6,3	10,6	<b>1.302,01</b>	<b>1.497,30</b>
<b>QAM-180-045/GD</b>	1865	450	761	545	337	403	1,23	600	8,1	13,8	<b>1.539,14</b>	<b>1.770,01</b>
<b>QAM-140-060/GD</b>	1433	600	749	537	331	397	1,23	600	7,9	13,4	<b>1.418,07</b>	<b>1.630,78</b>
<b>QAM-180-060/GD</b>	1865	600	966	692	427	512	1,23	900	10,2	17,0	<b>1.597,19</b>	<b>1.836,78</b>

Model	H <sup>④</sup> mm	L mm	Thermal output				Exp. n	Classification Electric heating element Watt	V dm <sup>3</sup>	M kg	Price
			EN 442 <sup>③</sup> W	70/55/24 W	55/45/24 W	55/45/20 W					Chrome €

#### Chrome-plated version

<b>QAMC-140-045/GD</b>	1433	450	381	269	162	196	1,29	300	6,3	10,8	<b>2.688,51</b>
<b>QAMC-180-045/GD</b>	1865	450	491	345	207	252	1,29	300	8,1	13,8	<b>3.199,33</b>
<b>QAMC-140-060/GD</b>	1433	600	486	343	207	250	1,29	300	7,9	13,3	<b>2.967,15</b>
<b>QAMC-180-060/GD</b>	1865	600	627	442	267	322	1,29	600	10,2	17,0	<b>3.327,05</b>

① For special colours in categories 1 and 2, see "Special solutions" and "Colour chart"

③ Thermal output to EN 442, ΔT 50 K (75/65/20°C)

④ Total height incl. electric heating element

For legend, see "Electric operation and Ecodesign Directive" on page 166

## Zehnder Quaro



### Electric-only operation with new electric platform

Model	H <sup>ⓐ</sup> mm	L mm	Classification Electric heating element Watt	Price RAL 9016 €		Price Cat. 1 <sup>ⓑ</sup> €	
				Heating element IHC (C)	Heating element IHE (A)	Heating element IHC (C)	Heating element IHE (A)

#### Painted version

QAZSS100040E_ZD	971	450	400	1.098,18	861,97	1.297,97	1.053,07
QAZSS140045E_ZD	1403	450	600	1.149,76	900,31	1.359,58	1.101,00
QAZSS180045E_ZD	1835	450	900	1.426,31	1.169,50	1.703,84	1.434,96
QAZSS140060E_ZD	1403	600	600	1.197,39	945,87	1.419,13	1.157,97
QAZSS180060E_ZD	1835	600	900	1.483,53	1.224,23	1.775,36	1.503,37

Model	H <sup>ⓐ</sup> mm	L mm	Classification Electric heating element Watt	Price Chrome €	
				Heating element IHC (C)	Heating element IHE (A)

#### Chrome-plated version

QAZCS140045E_ZD	1403	450	400	2.070,99	1.793,95
QAZCS180045E_ZD	1835	450	900	2.643,21	2.335,78
QAZCS140060E_ZD	1403	600	600	2.166,34	1.885,15
QAZCS180060E_ZD	1835	600	900	2.765,29	2.463,56



### Electric-only operation

Model	H mm	L mm	Classification Electric heating element Watt	Price RAL 9016	Price <sup>ⓑ</sup> Cat. 1
				€	€

#### Painted version

QAE-100-045/GD	1001	450	300	1.204,11	1.384,73
QAE-140-045/GD	1433	450	500	1.302,01	1.497,30
QAE-180-045/GD	1865	450	600	1.539,14	1.770,01
QAE-140-060/GD	1433	600	600	1.418,07	1.630,78
QAE-180-060/GD	1865	600	900	1.597,19	1.836,78

Model	H mm	L mm	Classification Electric heating element Watt	Price Chrome
				€

#### Chrome-plated version

QAEC-140-045/GD	1433	450	300	2.688,51
QAEC-180-045/GD	1865	450	300	3.199,33
QAEC-140-060/GD	1433	600	300	2.967,15
QAEC-180-060/GD	1865	600	600	3.327,05

ⓐ For special colours in categories 1 and 2, see “Special solutions” and “Colour chart”

ⓑ Total height w/o heating element. For IHC +128 mm, for IHE +50 mm.

For legend, see “Electric operation and Ecodesign Directive” on page 166

## Zehnder Quaro

### Standard scope of delivery for operation on hot water central heating system

- Powder coating to DIN 55900, RAL 9016
- 4 x ½" connections, connection centre 50 mm female thread for flow/return and electric heating element (on site) on left or right
- Dual energy operation: Electric heating element RACY-S, pre-assembled on the right, with remote control device, incl. batteries, with selectable operating modes: manual (above room temperature), weekly programme, timer, off. Electric heating element cover in colour of radiator
- Designer directional air vent, chrome ½"
- Mounting accessories in colour of radiator
- Packaging

### Standard scope of delivery for electric operation

- Powder coating to DIN 55900, RAL 9016
- Filled with heat transfer fluid
- Mounting accessories and electric heating element control box cover in colour of radiator
- Packaging
- Version with heating element IHC: With built-in immersion heater in outer manifold and control unit with LED matrix display, control unit white, black or grey (depending on radiator colour), cable and plug in colour of control unit
- Version with heating element IHE: With built-in immersion heater in outer manifold, without control option, control unit in white (if radiator is white) or chrome (for all other radiator surfaces).
- Version with integrated heating element RACY-S: with remote control device, incl. battery, with selectable operating modes: manual (above room temperature), weekly programme, timer, off.

Special solution on request (surcharge)	Article number	Price €
▪ Special finish to category 2 (surcharge on cat. 1)	QA00011640	146,76
▪ Remote control EASY for IHC (RCE)*	887970	133,38
▪ Room divider version with two wall brackets and foot support, white, chrome, special colour	-	257,07
▪ Room divider version with two wall brackets without foot support, white, chrome, special colour	-	199,02
▪ Models for electric operation in room divider version	-	On request
▪ Zehnder valves, lockshield valves and connection fittings	-	See p. 159 onwards



Remote control EASY can be ordered as accessory for heating element IHC.

# Zehnder Quaro

## Operation on hot water central heating system:

Wall mounting  
(with attached welded brackets)

Room divider installation  
(special version without attached welded brackets in <sup>2)</sup>)

## Electric operation:

with heating element IHC

## Dual-energy operation:

with heating element IHC  
(to be ordered separately)

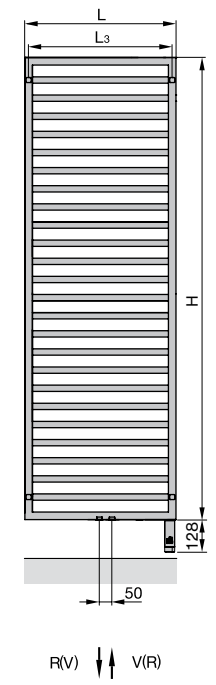
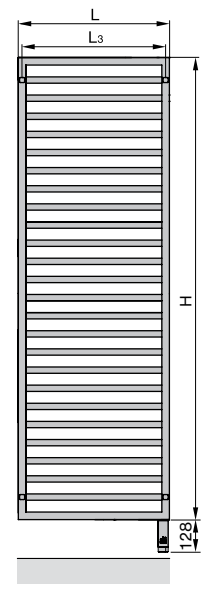
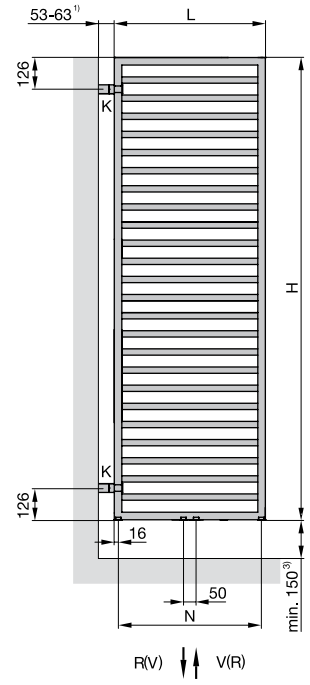
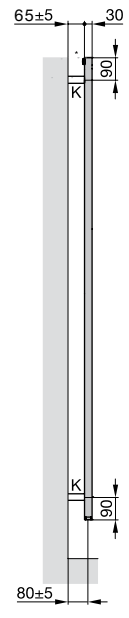
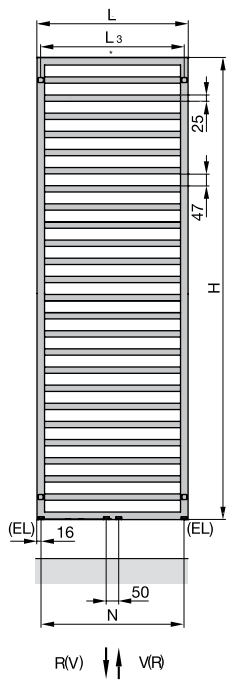

- H = Height
- L = Length
- EL = Connection for electric heating element
- K = Bracket
- V = Flow 1/2"
- R = Return 1/2"
- \* = Venting 1/2"
- N = Connection centre
- L<sub>3</sub> = Fixing dimension, L - 30 mm

Dimensions in mm

- 1) Lengthening possible with brackets for larger wall clearance
- 2) The standard version of the radiator is not suitable for room divider installation
- 3) Max. 170 mm for installation with foot support in standard length

## Electric operation:

with heating element RACY-S

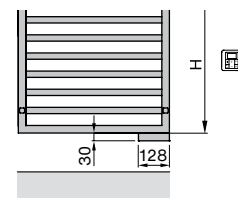

## Dual-energy operation:

with heating element RACY-S  
(Factory installed)

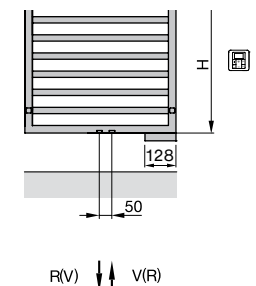

## Zehnder Subway



Radiator surface: Chrome



Radiator top with IHE / Radiator bottom with RACY-S

### Operation on hot water central heating system

Zehnder Subway decorative radiator made from horizontally arranged precision steel tubes with surrounding square tubes, fully welded, invisible welds due to laser welding technology. Round tubes Ø 23 mm, regularly arranged in the frame of square 30 x 30 mm tube. Thermal output tested to EN 442, with CE marking. With recessed connections on lower square tube, central 1/2" for flow/return, connection centre 50 mm and outside left and right 1/2" for electric heating element, with directional air vent. Connections for dual energy operation: Flow/return 2 x 1/2" at bottom centre, spacing 50 mm and factory integrated electric heating element RACY-S, bottom right, with separate remote control device model 2. Radiator with powder coating, in colour RAL 9016 as standard, in special colour, chrome or version in brushed V4A stainless steel on request. Delivered ready to install with matching wall brackets and packaging. Room divider version: Radiator without threaded bolts for wall bracket, incl. room divider mounting set.

Operating pressure	max. 10.0 bar
Hot water central heating system operating temperature	max. 110 °C
Dual energy operation operating temperature (model SUBM)	max. 95 °C
Height	..... mm
Length	..... mm
Model	.....

### Benefits

- Classic design
- Outside frame lends geometric look
- Generous spacing to hang towels
- Variant in brushed stainless steel
- Also available as room divider version
- Special 150 mm connection available
- Extra model for use as guest WC radiator
- Dual energy operation: electric heating element RACY-S integrated elegantly

### Electric operation

Zehnder Subway decorative radiator, electric-only, made from horizontally arranged precision steel tubes with surrounding square tubes, fully welded, invisible welds due to laser welding technology. Standard version with powder coating, in colour RAL 9016, special colour, chrome or version in brushed V4A stainless steel on request. Filled with heat transfer fluid. Delivered ready to install with elegant wall brackets.

### Electric operation with heating element IHC

Heating element IHC with integrated control function and modular control concept. Basic functions can be set directly on the heating element. For an even more comfortable and easy control, remote control EASY (RCE, available as accessory) or the Zehnder Connect app can be used. Control unit colour in either white, grey or black, depending on radiator colour, built-in on outer collector tube. Connection cable an plug in radiator colour, protection class IP54.

### Electric operation with heating element IHE

Heating element IHE (without control function) for application in combination with on-site control (e. g. BMS systems). Control unit colour either white or chrome, depending on radiator colour, built-in on outer collector tube. Connection cable with Schuko plug in white or grey, protection class IP65.

### Electric operation with heating element RACY-S

Heating element RACY-S, degree of protection IP44 (splash-proof), with Euro plug, installation at bottom left., cover in radiator colour. Separate, battery-operated remote control device model 2 for controlling the room temperature.

# Zehnder Subway

## Overview of models

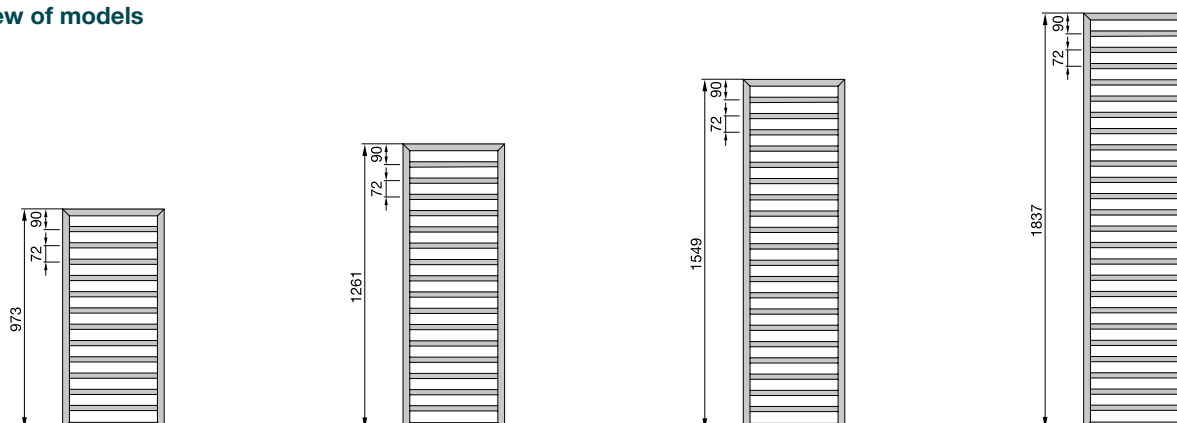

## Connection to hot water central heating system

Model	H mm	L mm	Thermal output				Exp. n	Classification Electric heating element Watt	V dm <sup>3</sup>	M kg	Price RAL 9016 €	Price <sup>①</sup> Cat. 1 €
			EN 442 <sup>②</sup> W	70/55/24 W	55/45/24 W	55/45/20 W						

### Painted version

<b>SUB-100-045</b>	973	450	401	286	175	210	1,25	300	3,5	6,7	<b>341,63</b>	<b>427,04</b>
<b>SUB-130-045</b>	1261	450	509	363	222	267	1,25	300	4,5	8,6	<b>384,70</b>	<b>480,88</b>
<b>SUB-150-045</b>	1549	450	615	438	268	322	1,25	600	5,4	10,6	<b>441,93</b>	<b>539,10</b>
<b>SUB-180-045</b>	1837	450	715	511	314	377	1,24	600	6,3	12,2	<b>477,06</b>	<b>581,42</b>
<b>SUB-100-060</b>	973	600	499	356	218	262	1,25	300	4,3	8,3	<b>372,58</b>	<b>465,73</b>
<b>SUB-130-060</b>	1261	600	639	455	279	335	1,25	600	5,4	10,5	<b>428,09</b>	<b>535,11</b>
<b>SUB-150-060</b>	1549	600	772	550	337	405	1,25	600	7,2	12,5	<b>482,33</b>	<b>602,91</b>
<b>SUB-180-060</b>	1837	600	898	642	395	473	1,24	900	7,7	14,7	<b>534,08</b>	<b>659,75</b>

Model	H mm	L mm	Thermal output				Exp. n	Classification Electric heating element Watt	V dm <sup>3</sup>	M kg	Price Chrome €
			EN 442 <sup>②</sup> W	70/55/24 W	55/45/24 W	55/45/20 W					

### Chrome-plated version

<b>SUBC-100-045</b>	973	450	265	188	114	137	1,27	300	3,5	6,5	<b>970,28</b>
<b>SUBC-130-045</b>	1261	450	336	238	145	174	1,27	300	4,5	8,4	<b>1.070,23</b>
<b>SUBC-150-045</b>	1549	450	413	293	178	214	1,27	300	5,4	10,1	<b>1.263,69</b>
<b>SUBC-180-045</b>	1837	450	486	345	209	252	1,27	300	6,3	11,8	<b>1.412,74</b>
<b>SUBC-100-060</b>	973	600	329	234	143	172	1,26	300	4,3	8,1	<b>1.022,12</b>
<b>SUBC-130-060</b>	1261	600	408	290	177	213	1,26	300	5,4	10,2	<b>1.127,01</b>
<b>SUBC-150-060</b>	1549	600	502	357	218	262	1,26	300	7,2	12,3	<b>1.329,37</b>
<b>SUBC-180-060</b>	1837	600	590	419	256	308	1,26	600	7,7	14,3	<b>1.487,30</b>

Model	H mm	L mm	Thermal output				Exp. n	Classification Electric heating element Watt	V dm <sup>3</sup>	M kg	Price Stainless steel €
			EN 442 <sup>②</sup> W	70/55/24 W	55/45/24 W	55/45/20 W					

### Stainless-steel version

<b>SUBI-100-045</b>	973	450	287	203	124	149	1,27	300	3,5	6,7	<b>862,81</b>
<b>SUBI-130-045</b>	1261	450	370	262	159	192	1,27	300	4,5	8,7	<b>1.086,85</b>
<b>SUBI-150-045</b>	1549	450	445	315	192	231	1,27	300	5,4	10,4	<b>1.261,93</b>
<b>SUBI-180-045</b>	1837	450	523	370	224	270	1,28	300	6,3	12,2	<b>1.459,48</b>
<b>SUBI-100-060</b>	973	600	356	253	154	186	1,26	300	4,3	8,3	<b>1.046,64</b>
<b>SUBI-130-060</b>	1261	600	447	318	194	233	1,26	300	5,4	10,4	<b>1.282,66</b>
<b>SUBI-150-060</b>	1549	600	538	383	235	282	1,25	300	7,2	12,4	<b>1.527,08</b>
<b>SUBI-180-060</b>	1837	600	633	454	280	335	1,23	600	7,7	14,4	<b>1.753,79</b>

① For special colours in categories 1 and 2, see "Special solutions" and "Colour chart"

② Thermal output to EN 442, ΔT 50 K (75/65/20°C)

## Zehnder Subway

### Connection to hot water central heating system – Version for guest WC

Model	H mm	L mm	Thermal output				Exp. n	Classification Electric heating element Watt	V dm <sup>3</sup>	M kg	Price RAL 9016 €	Price <sup>①</sup> Cat. 1 €
			EN 442 <sup>③</sup> W	70/55/24 W	55/45/24 W	55/45/20 W						

#### Painted version

<b>SUB-060-045</b>	613	450	310	221	135	162	1,25	-	2,3	5,2	<b>296,26</b>	<b>365,69</b>
--------------------	-----	-----	-----	-----	-----	-----	------	---	-----	-----	---------------	---------------

Model	H mm	L mm	Thermal output				Exp. n	Classification Electric heating element Watt	V dm <sup>3</sup>	M kg	Price Chrome €
			EN 442 <sup>③</sup> W	70/55/24 W	55/45/24 W	55/45/20 W					

#### Chrome-plated version

<b>SUBC-060-045</b>	613	450	205	145	88	106	1,27	-	2,3	5,0	<b>776,48</b>
---------------------	-----	-----	-----	-----	----	-----	------	---	-----	-----	---------------

Model	H mm	L mm	Thermal output				Exp. n	Classification Electric heating element Watt	V dm <sup>3</sup>	M kg	Price Stainless steel €
			EN 442 <sup>③</sup> W	70/55/24 W	55/45/24 W	55/45/20 W					

#### Stainless-steel version

<b>SUBI-060-045</b>	613	450	221	157	95	115	1,27	-	2,3	5,1	<b>691,85</b>
---------------------	-----	-----	-----	-----	----	-----	------	---	-----	-----	---------------

### Connection for dual energy operation with integrated electric heating element IHC

Model	H mm	L mm	Thermal output				Exp. n	Classification Electric heating element Watt	V dm <sup>3</sup>	M kg	Price RAL 9016 €	Price <sup>①</sup> Cat. 1 €
			EN 442 <sup>③</sup> W	70/55/24 W	55/45/24 W	55/45/20 W						

#### Painted version

<b>SUBSS130045MCZD</b>	1261	450	509	363	222	267	1,25	500	4,5	8,6	<b>752,50</b>	<b>940,62</b>
<b>SUBSS150045MCZD</b>	1549	450	615	438	268	322	1,25	600	5,4	10,6	<b>882,68</b>	<b>1.103,35</b>
<b>SUBSS180045MCZD</b>	1837	450	715	511	314	377	1,24	600	6,3	12,2	<b>914,84</b>	<b>1.143,55</b>
<b>SUBSS130060MCZD</b>	1261	600	639	455	279	335	1,25	600	5,4	10,5	<b>820,22</b>	<b>1.025,28</b>
<b>SUBSS150060MCZD</b>	1549	600	772	550	337	405	1,25	750	7,2	12,5	<b>913,94</b>	<b>1.142,43</b>
<b>SUBSS180060MCZD</b>	1837	600	898	642	395	473	1,24	900	7,7	14,7	<b>993,66</b>	<b>1.242,08</b>

Model	H mm	L mm	Thermal output				Exp. n	Classification Electric heating element Watt	V dm <sup>3</sup>	M kg	Price Chrome €
			EN 442 <sup>③</sup> W	70/55/24 W	55/45/24 W	55/45/20 W					

#### Chrome-plated version

<b>SUBCS130045MCZD</b>	1261	450	336	238	145	174	1,27	300	4,5	8,4	<b>1.463,25</b>
<b>SUBCS150045MCZD</b>	1549	450	413	293	178	214	1,27	300	5,4	10,1	<b>1.687,06</b>
<b>SUBCS180045MCZD</b>	1837	450	486	345	209	252	1,27	300	6,3	11,8	<b>1.851,01</b>
<b>SUBCS130060MCZD</b>	1261	600	408	290	177	213	1,26	300	5,4	10,2	<b>1.536,71</b>
<b>SUBCS150060MCZD</b>	1549	600	502	357	218	262	1,26	300	7,2	12,3	<b>1.759,31</b>
<b>SUBCS180060MCZD</b>	1837	600	590	419	256	308	1,26	600	7,7	14,3	<b>1.938,53</b>

Model	H mm	L mm	Thermal output				Exp. n	Classification Electric heating element Watt	V dm <sup>3</sup>	M kg	Price Stainless steel €
			EN 442 <sup>③</sup> W	70/55/24 W	55/45/24 W	55/45/20 W					

#### Stainless-steel version

<b>SUBIS130045MCZD</b>	1261	450	370	262	159	192	1,27	300	4,5	8,7	<b>1.605,79</b>
<b>SUBIS150045MCZD</b>	1549	450	445	315	192	231	1,27	300	5,4	10,4	<b>1.890,46</b>
<b>SUBIS180045MCZD</b>	1837	450	523	370	224	270	1,28	500	6,3	12,2	<b>2.166,85</b>
<b>SUBIS130060MCZD</b>	1261	600	447	318	194	233	1,26	300	5,4	10,4	<b>1.917,86</b>
<b>SUBIS150060MCZD</b>	1549	600	538	383	235	282	1,25	500	7,2	12,4	<b>2.272,89</b>
<b>SUBIS180060MCZD</b>	1837	600	633	454	280	335	1,23	600	7,7	14,4	<b>2.600,64</b>

① For special colours in categories 1 and 2, see "Special solutions" and "Colour chart"

③ Thermal output to EN 442, ΔT 50 K (75/65/20°C)

## Zehnder Subway



### Connection for dual energy operation with integrated electric heating element<sup>1)</sup>

Model	H <sup>Ⓞ</sup> mm	L mm	Thermal output				Exp. n	Classification Electric heating element Watt	V dm <sup>3</sup>	M kg	Price RAL 9016 €	Price <sup>Ⓛ</sup> Cat. 1 €
			EN 442 <sup>Ⓢ</sup> W	70/55/24 W	55/45/24 W	55/45/20 W						

#### Painted version

<b>SUBM-130-45/GD</b>	1291	450	509	363	222	267	1,25	500	4,5	8,6	<b>762,94</b>	<b>953,68</b>
<b>SUBM-150-45/GD</b>	1579	450	615	438	268	322	1,25	600	5,4	10,6	<b>807,37</b>	<b>1.009,22</b>
<b>SUBM-180-45/GD</b>	1867	450	715	511	314	377	1,24	600	6,3	12,2	<b>844,56</b>	<b>1.055,70</b>
<b>SUBM-130-60/GD</b>	1291	600	639	455	279	335	1,25	600	5,4	10,5	<b>805,93</b>	<b>1.007,42</b>
<b>SUBM-150-60/GD</b>	1579	600	772	550	337	405	1,25	750	7,2	12,5	<b>859,33</b>	<b>1.074,17</b>
<b>SUBM-180-60/GD</b>	1867	600	898	642	395	473	1,24	900	7,7	14,7	<b>914,30</b>	<b>1.142,88</b>

Model	H <sup>Ⓞ</sup> mm	L mm	Thermal output				Exp. n	Classification Electric heating element Watt	V dm <sup>3</sup>	M kg	Price Chrome €
			EN 442 <sup>Ⓢ</sup> W	70/55/24 W	55/45/24 W	55/45/20 W					

#### Chrome-plated version

<b>SUBMC-130-45/GD</b>	1261	450	336	238	145	174	1,27	300	4,5	8,4	<b>1.957,59</b>
<b>SUBMC-150-45/GD</b>	1549	450	413	293	178	214	1,27	300	5,4	10,1	<b>2.308,26</b>
<b>SUBMC-180-45/GD</b>	1837	450	486	345	209	252	1,27	300	6,3	11,8	<b>2.662,40</b>
<b>SUBMC-130-60/GD</b>	1261	600	408	290	177	213	1,26	300	5,4	10,2	<b>2.064,46</b>
<b>SUBMC-150-60/GD</b>	1549	600	502	357	218	262	1,26	300	7,2	12,3	<b>2.566,90</b>
<b>SUBMC-180-60/GD</b>	1837	600	590	419	256	308	1,26	600	7,7	14,3	<b>2.798,97</b>

Model	H mm	L mm	Thermal output				Exp. n	Classification Electric heating element Watt	V dm <sup>3</sup>	M kg	Price Stainless steel €
			EN 442 <sup>Ⓢ</sup> W	70/55/24 W	55/45/24 W	55/45/20 W					

#### Stainless-steel version

<b>SUBMI-130-45/GD</b>	1261	450	370	262	159	192	1,27	300	4,5	8,7	<b>1.459,99</b>
<b>SUBMI-150-45/GD</b>	1549	450	445	315	192	231	1,27	300	5,4	10,4	<b>1.646,61</b>
<b>SUBMI-180-45/GD</b>	1837	450	523	370	224	270	1,28	500	6,3	12,2	<b>1.839,39</b>
<b>SUBMI-130-60/GD</b>	1261	600	447	318	194	233	1,26	300	5,4	10,4	<b>1.702,38</b>
<b>SUBMI-150-60/GD</b>	1549	600	538	383	235	282	1,25	500	7,2	12,4	<b>1.914,13</b>
<b>SUBMI-180-60/GD</b>	1837	600	633	454	280	335	1,23	600	7,7	14,4	<b>2.141,78</b>

<sup>1)</sup> Maximum operating pressure for dual energy operation: 4 bar

<sup>Ⓛ</sup> For special colours in categories 1 and 2, see "Special solutions" and "Colour chart"

<sup>Ⓢ</sup> Thermal output to EN 442, ΔT 50 K (75/65/20°C)

<sup>Ⓞ</sup> Total height incl. electric heating element

For legend, see "Electric operation and Ecodesign Directive" on page 166

## Zehnder Subway



### Electric-only operation with new electric platform

Model	H <sup>②</sup> mm	L mm	Classification Electric heating element Watt	Price RAL 9016 €		Price Cat. 1 <sup>①</sup> €	
				Heating element IHC (C)	Heating element IHE (A)	Heating element IHC (C)	Heating element IHE (A)

Painted version							
SUBSS130045E_ZD	1261	450	500	819,48	529,90	1.024,35	662,37
SUBSS150045E_ZD	1549	450	600	922,81	582,45	1.153,51	728,06
SUBSS180045E_ZD	1837	450	750	966,39	641,47	1.207,99	801,84
SUBSS130060E_ZD	1261	600	600	857,50	586,76	1.071,88	733,44
SUBSS150060E_ZD	1549	600	750	955,48	652,18	1.194,35	815,22
SUBSS180060E_ZD	1837	600	900	1.038,83	746,07	1.298,54	932,59

Model	H <sup>②</sup> mm	L mm	Classification Electric heating element Watt	Price Chrome €	
				Heating element IHC (C)	Heating element IHE (A)

Chrome-plated version					
SUBCS130045E_ZD	1261	450	300	1.529,76	1.287,28
SUBCS150045E_ZD	1549	450	300	1.763,74	1.500,06
SUBCS180045E_ZD	1837	450	300	1.935,15	1.664,01
SUBCS130060E_ZD	1261	600	300	1.606,56	1.349,71
SUBCS150060E_ZD	1549	600	300	1.839,28	1.572,31
SUBCS180060E_ZD	1837	600	600	2.026,65	1.757,03

Model	H <sup>②</sup> mm	L mm	Classification Electric heating element Watt	Price Stainless steel €	
				Heating element IHC (C)	Heating element IHE (A)

Stainless-steel version					
SUBIS130045E_ZD	1261	450	300	1.602,59	1.284,64
SUBIS150045E_ZD	1549	450	300	1.825,37	1.512,37
SUBIS180045E_ZD	1837	450	500	2.065,52	1.733,48
SUBIS130060E_ZD	1261	600	300	1.851,99	1.534,28
SUBIS150060E_ZD	1549	600	500	2.126,05	1.818,32
SUBIS180060E_ZD	1837	600	600	2.395,29	2.080,51

① For special colours in categories 1 and 2, see "Special solutions" and "Colour chart"

② Total height w/o heating element. For IHC +128 mm, for IHE +50 mm.

For legend, see "Electric operation and Ecodesign Directive" on page 166

## Zehnder Subway



### Electric-only operation

Model	H <sup>③</sup> mm	L mm	Classification Electric heating element Watt	Price RAL 9016 €	Price <sup>①</sup> Cat. 1 €
-------	----------------------	---------	---	------------------------	-----------------------------------

#### Painted version

SUBE-130-45/GD	1261	450	500	<b>815,12</b>	<b>1.018,90</b>
SUBE-150-45/GD	1549	450	600	<b>885,59</b>	<b>1.106,99</b>
SUBE-180-45/GD	1837	450	750	<b>948,50</b>	<b>1.185,63</b>
SUBE-130-60/GD	1261	600	600	<b>882,17</b>	<b>1.102,71</b>
SUBE-150-60/GD	1549	600	750	<b>970,40</b>	<b>1.213,00</b>
SUBE-180-60/GD	1837	600	900	<b>1.035,31</b>	<b>1.294,14</b>

Model	H <sup>③</sup> mm	L mm	Classification Electric heating element Watt	Price Chrome €
-------	----------------------	---------	---	----------------------

#### Chrome-plated version

SUBEC-130-45/GD	1261	450	300	<b>1.909,72</b>
SUBEC-150-45/GD	1549	450	300	<b>2.252,26</b>
SUBEC-180-45/GD	1837	450	300	<b>2.662,40</b>
SUBEC-130-60/GD	1261	600	300	<b>2.064,46</b>
SUBEC-150-60/GD	1549	600	300	<b>2.504,31</b>
SUBEC-180-60/GD	1837	600	600	<b>2.729,68</b>

Model	H <sup>③</sup> mm	L mm	Classification Electric heating element Watt	Price Stainless steel €
-------	----------------------	---------	---	-------------------------------

#### Stainless-steel version

SUBEI-130-45/GD	1261	450	300	<b>1.591,68</b>
SUBEI-150-45/GD	1549	450	300	<b>1.828,23</b>
SUBEI-180-45/GD	1837	450	500	<b>2.053,99</b>
SUBEI-130-60/GD	1261	600	300	<b>1.840,41</b>
SUBEI-150-60/GD	1549	600	500	<b>2.141,62</b>
SUBEI-180-60/GD	1837	600	600	<b>2.396,33</b>

① For special colours in categories 1 and 2, see "Special solutions" and "Colour chart"

③ Total height incl. electric heating element

For legend, see "Electric operation and Ecodesign Directive" on page 166

## Zehnder Subway

### Standard scope of delivery for operation on hot water central heating system

- Powder coating to DIN 55900, RAL 9016
- 4 x ½" connections for flow, return, left-hand or right-hand electric heating element (on site)
- Dual energy operation: Electric heating element RACY-S, pre-assembled on the right, with remote control device, incl. batteries, with selectable operating modes: manual (above room temperature), weekly programme, timer, off. Electric heating element cover in colour of radiator
- ½" chrome directional air vent
- Mounting accessories in colour of radiator
- Packaging

### Standard scope of delivery for electric operation

- Powder coating to DIN 55900, RAL 9016
- Filled with heat transfer fluid
- Mounting accessories and electric heating element control box cover in colour of radiator
- Packaging
- Version with heating element IHC: With built-in immersion heater in outer manifold and control unit with LED matrix display, control unit white, black or grey (depending on radiator colour), cable and plug in colour of control unit
- Version with heating element IHE: With built-in immersion heater in outer manifold, without control option, control unit in white (if radiator is white) or chrome (for all other radiator surfaces).
- Version with integrated heating element RACY-S: with remote control device, incl. battery, with selectable operating modes: manual (above room temperature), weekly programme, timer, off.

Special solution on request (surcharge)	Article number	Price €
▪ Special finish to category 2 (surcharge on cat. 1)	U100011640	146,76
▪ Remote control EASY for IHC (RCE)*	887970	133,38
▪ Surface in metal look: stainless-steel look (reduced output approx. 8%)	U100012332	As in Cat. 1
▪ Room divider version with two wall brackets and foot support, white, chrome, special colour	-	257,06
▪ Room divider version with two wall brackets without foot support, white, chrome, special colour	-	199,02
▪ Models for electric operation in room divider version	-	On request
▪ Zehnder valves, lockshield valves and connection fittings	-	See p. 159 onwards
▪ Connection from bottom to bottom, central, spacing 150 mm	U100062530	85,31



Remote control EASY can be ordered as accessory for heating element IHC.

# Zehnder Subway

## Operation on hot water central heating system:

Wall mounting  
(with welded-on threaded bolts)

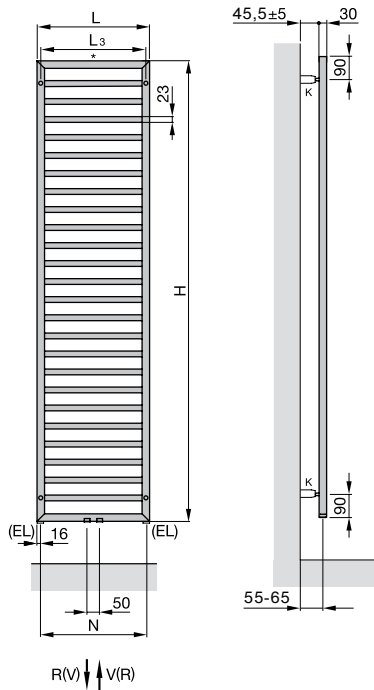

Room divider installation  
(special solution without welded-on threaded bolts) 1)

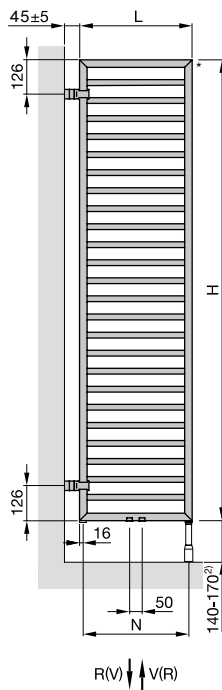

## Electric operation:

with heating element IHC

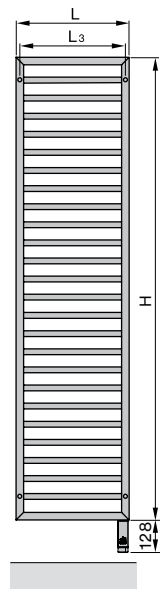

## Dual energy operation:

with heating element IHC  
(Factory installed)

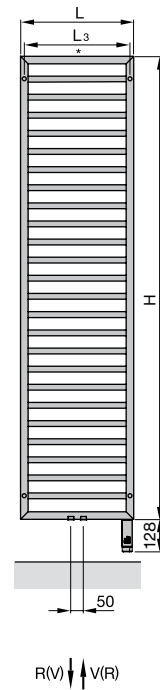

## Operation on central heating system:

Version for guest WC

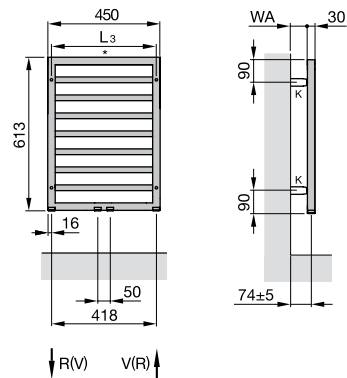

## Electric operation:

with heating element RACY-S

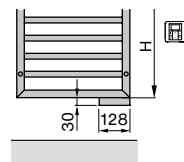

## Dual energy operation:

with heating element RACY-S  
(Factory installed)

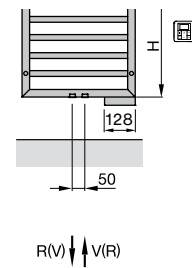

- H = Height
- L = Length
- EL = Connection for electric heating element
- K = Bracket
- V = Flow 1/2"
- R = Return 1/2"
- \* = Venting 1/2"
- N = Connection centre
- WA = Wall clearance 40-50 mm
- L<sub>3</sub> = Fixing dimension, L - 30 mm

Dimensions in mm

1) The standard version of the radiator is not suitable for room divider installation  
2) For installation with foot support in standard length

## Zehnder Forma Asym



Radiator colour: Traffic White



### Operation on hot water central heating system

Zehnder Forma Asym decorative radiator made from horizontally arranged precision steel tubes welded to vertically arranged round tubes. Invisible connection due to capstan welding technology.

Horizontal tubes each branch asymmetrically from the laterally arranged manifolds. Horizontal steel tubes Ø 25 mm, vertical header tubes Ø 38 mm.

Thermal output tested to EN 442, with CE marking.

With connections at bottom, 2 x ½" for flow/return, connection centre 50 mm. Alternatively with additional 2 x ½" centre connections, spacing 50 mm for flow/return. Radiator with powder coating, in colour RAL 9016 as standard, in special colour on request. Delivered ready to install with elegant wall brackets.

Operating pressure	max. 10 bar
Operating temperature	max. 95 °C
Height	..... mm
Length	..... mm
Model	.....

### Benefits

- Cross-connected tubes lend relaxed look
- Open access from both sides makes it very convenient for hanging and sliding towels in from the side
- Large wall clearance for snugly warm towels
- Diverse range of models with left-hand or right-hand version
- Dual energy operation possible with centre connections as an option

### Electric operation

Zehnder Forma Asym decorative radiator as multifunctional bathroom heater, electric-only, made from horizontally arranged precision steel tubes welded to vertically arranged round tubes with invisible welds due to capstan welding technology. Horizontal steel tubes Ø 25 mm, vertical header tubes Ø 38 mm. Delivered ready to install with elegant wall brackets. Standard version with powder coating, in colour RAL 9016, in special colour on request.

### Electric operation with heating element IHC

Heating element IHC with integrated control function and modular control concept. Basic functions can be set directly on the heating element. For an even more comfortable and easy control, remote control EASY (RCE, available as accessory) or the Zehnder Connect app can be used. Control unit colour in either white, grey or black, depending on radiator colour, built-in on outer collector tube. Connection cable and plug in radiator colour, protection class IP54.

### Electric operation with heating element IHE

Heating element IHE (without control function) for application in combination with on-site control (e. g. BMS systems). Control unit colour either white or chrome, depending on radiator colour, built-in on outer collector tube. Connection cable with Schuko plug in white or grey, protection class IP65.

### Electric operation with heating element RACY-C

Heating element RACY-C, degree of protection IP44 (splash-proof), with Euro plug, installation at bottom left, cover in radiator colour. Separate, battery-operated remote control device model 2 for controlling the room temperature.

## Zehnder Forma Asym

### Overview of models:

Right-hand version

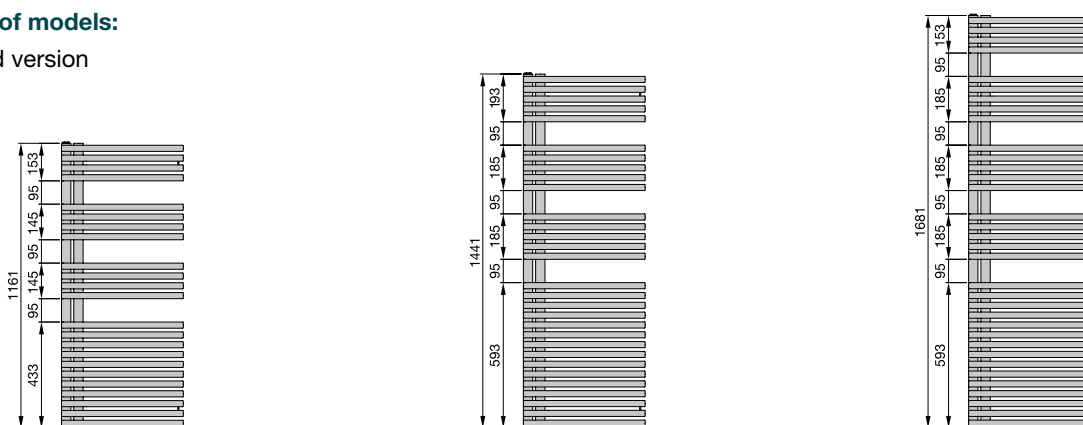

### Connection to hot water central heating system

Model	H mm	L mm	EN 442 <sup>③</sup> W	Thermal output			Exp. n	Classification Electric heating element Watt	V dm <sup>3</sup>	M kg	Price RAL 9016 €	Price <sup>①</sup> Cat. 1 €
				70/55/24 W	55/45/24 W	55/45/20 W						

#### Painted version, right-hand version

LFAR-120-050	1161	496	547	389	237	285	1,26	-	7,0	12,1	373,68	467,09
LFAR-150-050	1441	496	672	475	288	347	1,28	-	8,8	15,0	441,58	551,97
LFAR-170-050	1681	496	778	552	335	404	1,27	-	10,1	17,1	473,19	591,49
LFAR-120-060	1161	596	628	446	272	327	1,26	-	8,0	13,8	406,54	508,17
LFAR-150-060	1441	596	772	544	328	396	1,29	-	10,0	17,2	479,98	599,98
LFAR-170-060	1681	596	894	634	385	464	1,27	-	11,4	19,6	514,63	643,28

#### Painted version, left-hand version

LFAL-120-050	1161	496	547	389	237	285	1,26	-	7,0	12,1	373,68	467,09
LFAL-150-050	1441	496	672	475	288	347	1,28	-	8,8	15,0	433,40	541,75
LFAL-170-050	1681	496	778	552	335	404	1,27	-	10,1	17,1	473,19	591,49
LFAL-120-060	1161	596	628	446	272	327	1,26	-	8,0	13,8	406,54	508,17
LFAL-150-060	1441	596	772	544	328	396	1,29	-	10,0	17,2	471,41	589,26
LFAL-170-060	1681	596	894	634	385	464	1,27	-	11,4	19,6	514,63	643,28

### Connection to hot water central heating system with 50 mm centre connections

Model	H mm	L mm	EN 442 <sup>③</sup> W	Thermal output			Exp. n	Classification Electric heating element Watt	V dm <sup>3</sup>	M kg	Price RAL 9016 €	Price <sup>①</sup> Cat. 1 €
				70/55/24 W	55/45/24 W	55/45/20 W						

#### Painted version, right-hand version

LFAR-120-050-05	1161	496	547	389	237	285	1,26	300	7,0	12,1	422,18	527,73
LFAR-150-050-05	1441	496	672	475	288	347	1,28	600	8,8	15,0	491,31	614,14
LFAR-170-050-05	1681	496	778	552	335	404	1,27	600	10,1	17,1	522,42	653,02
LFAR-120-060-05	1161	596	628	446	272	327	1,26	600	8,0	13,8	457,35	571,69
LFAR-150-060-05	1441	596	772	544	328	396	1,29	600	10,0	17,2	532,16	665,20
LFAR-170-060-05	1681	596	894	634	385	464	1,27	900	11,4	19,6	555,92	694,90

#### Painted version, left-hand version

LFAL-120-050-05	1161	496	547	389	237	285	1,26	300	7,0	12,1	422,18	527,73
LFAL-150-050-05	1441	496	672	475	288	347	1,28	600	8,8	15,0	482,21	602,76
LFAL-170-050-05	1681	496	778	552	335	404	1,27	600	10,1	17,1	522,42	653,02
LFAL-120-060-05	1161	596	628	446	272	327	1,26	600	8,0	13,8	457,35	571,69
LFAL-150-060-05	1441	596	772	544	328	396	1,29	600	10,0	17,2	522,65	653,32
LFAL-170-060-05	1681	596	894	634	385	464	1,27	900	11,4	19,6	566,41	708,01

① For special colours in categories 1 and 2, see "Special solutions" and "Colour chart"

③ Thermal output according to EN 442, ΔT 50 K (75/65/20°C)

## Zehnder Forma Asym

### Standard scope of delivery for operation on hot water central heating system

- Powder coating to DIN 55900, RAL 9016
- 2 x ½" connections for flow, return
- ½" directional air vent
- Mounting accessories in colour of radiator
- Packaging



### Electric-only operation with new electric platform

Model	H <sup>②</sup> mm	L mm	Classification Electric heating element Watt	Price RAL 9016 €		Price Cat. 1 <sup>①</sup> €	
				Heating element IHC (C)	Heating element IHE (A)	Heating element IHC (C)	Heating element IHE (A)

#### Painted version, right-hand version

LFASR120050E_ZD	1161	496	400	961,48	570,12	1 201,86	712,65
LFASR150050E_ZD	1441	496	600	1.063,27	650,38	1 329,08	812,98
LFASR170050E_ZD	1681	496	900	1.185,58	736,58	1 481,97	920,73
LFASR120060E_ZD	1161	596	600	1.017,63	617,13	1 272,04	771,42
LFASR150060E_ZD	1441	596	900	1.153,60	729,72	1 442,00	912,14
LFASR170060E_ZD	1681	596	900	1.214,50	779,17	1 518,13	973,97

#### Painted version, left-hand version

LFASL120050E_ZD	1161	496	500	972,29	578,65	1.215,36	723,31
LFASL150050E_ZD	1441	496	600	1.050,76	650,38	1.313,45	812,98
LFASL170050E_ZD	1681	496	750	1.158,32	748,09	1.447,90	935,11
LFASL120060E_ZD	1161	596	600	1.017,63	617,13	1.272,04	771,42
LFASL150060E_ZD	1441	596	750	1.153,60	729,72	1.442,00	912,14
LFASL170060E_ZD	1681	596	900	1.200,38	791,35	1.500,47	989,19



### Electric-only operation

Model	H <sup>③</sup> mm	L mm	Classification Electric heating element Watt	Price	Price
				RAL 9016 €	Cat. 1 €

#### Painted version, right-hand version

LFAER-120-50/GD	1186	496	500	1.036,31	1.295,39
LFAER-150-50/GD	1466	496	600	1.167,91	1.459,89
LFAER-170-50/GD	1706	496	750	1.216,02	1.520,02
LFAER-120-60/GD	1186	596	600	1.085,01	1.356,26
LFAER-150-60/GD	1466	596	750	1.224,30	1.530,38
LFAER-170-60/GD	1706	596	900	1.275,53	1.594,41

#### Painted version, left-hand version

LFAEL-120-50/GD	1186	496	500	1.036,31	1.295,39
LFAEL-150-50/GD	1466	496	600	1.167,91	1.459,89
LFAEL-170-50/GD	1706	496	750	1.216,02	1.520,02
LFAEL-120-60/GD	1186	596	600	1.085,01	1.356,26
LFAEL-150-60/GD	1466	596	750	1.224,30	1.530,38
LFAEL-170-60/GD	1706	596	900	1.275,53	1.594,41

### Standard scope of delivery for electric operation

- Powder coating to DIN 55900, RAL 9016
- Filled with non-flammable heat-transfer fluid (frost-proof to -10°C)
- Mounting accessories in colour of radiator
- Packaging
- Version with heating element IHC: With built-in immersion heater in outer manifold and control unit with LED matrix display, control unit white, black or grey (depending on radiator colour), cable and plug in colour of control unit
- Version with heating element IHE: With built-in immersion heater in outer manifold, without control option, control unit in white (if radiator is white ) or chrome (for all other radiator surfaces).
- Version with integrated heating element RACY-C: with remote control device, incl. battery, with selectable operating modes: manual (above room temperature), weekly programme, timer, off.

① For special colours in categories 1 and 2, see "Special solutions" and "Colour chart"

② Total height w/o heating element. For IHC +128 mm, for IHE +50 mm.

③ Total height incl. electric heating element

For legend, see "Electric operation and Ecodesign Directive" on page 166

# Zehnder Forma Asym

Special solution on request (surcharge)	Article number	Price €
▪ Special finish to category 2 (surcharge on cat. 1)	7600011640	146,76
▪ Remote control EASY for IHC (RCE)*	887970	133,38
▪ Surface in metal look: stainless-steel look (reduced output approx. 13%)	7600012332	As in Cat. 1
▪ Electric heating element for dual energy operation <sup>1)</sup>	-	See p. 152 onwards
▪ Zehnder thermostat LH2, M 30 x 1,5, white	819140	35,02
▪ Zehnder thermostat LH2, M 30 x 1,5, chrome	819148	60,35
▪ Zehnder valves, lockshield valves and connection fittings	-	See p. 159 onwards



Remote control EASY can be ordered as accessory for heating element IHC.

**Operation on hot water central heating system:**

Wall mounting  
Right-hand version

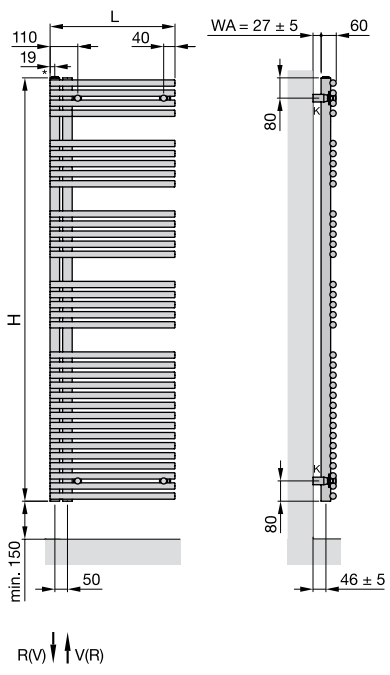

50 mm centre connections  
Left-hand version

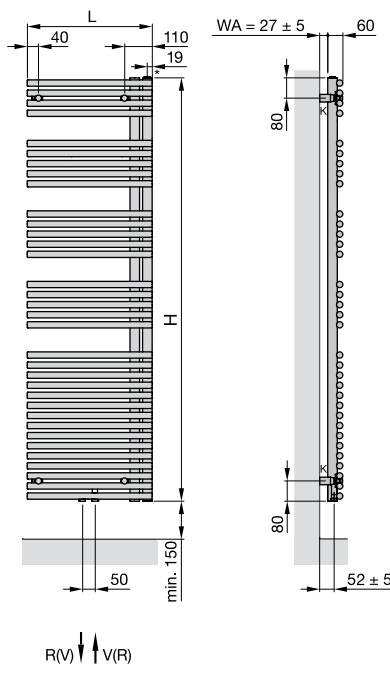

**Electric operation:**

with electric heating element IHC<sup>2)</sup>  
Right-hand version

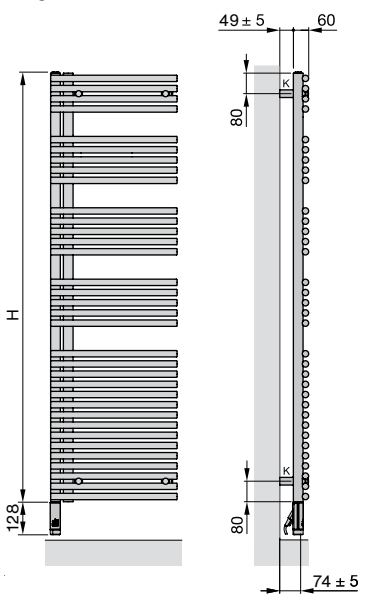

**Electric operation:**  
with electric heating element IHC  
Left-hand version

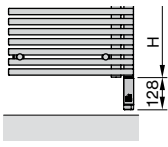

**Electric operation:**  
with electric heating element DBM  
Left-hand version

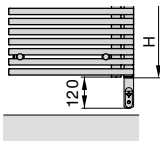

- H = Height
- L = Length
- K = Bracket
- WA = Wall clearance
- V = Flow 1/2"
- R = Return 1/2"
- \* = Venting 1/2"

Dimensions in mm

## Zehnder Forma Spa



Radiator colour: *Beige Quartz*

### Operation on hot water central heating system

Zehnder Forma Spa decorative radiator made from horizontally arranged precision steel tubes welded to vertically arranged round tubes. Invisible connection due to capstan welding technology. Single or double-layer version. Horizontal steel tubes Ø 25 mm, vertical header tubes Ø 38 mm. Thermal output tested to EN 442, with CE marking. With centre connections, ½" for flow/return, connection centre 50 mm and outside left and right, ½" for electric heating element, with directional air vent. Radiator with powder coating, in colour RAL 9016 as standard, in special colour or chrome on request; with packaging. Delivered ready to install with elegant wall brackets.

Operating pressure	max. 10 bar
Operating temperature	max. 110 °C
Height	..... mm
Length	..... mm
Model	.....

### Benefits

- Cross-connected tubes lend relaxed look
- Double-layer models for high thermal output
- Large wall clearance for snugly warm towels
- Centre connections
- Available with matching connection fittings
- Dual energy operation possible without T-piece

### Electric operation

Zehnder Forma Spa decorative radiator as multifunctional bathroom heater, electric-only, made from horizontally arranged precision steel tubes welded to vertically arranged round tubes with invisible welds due to capstan welding technology. Horizontal steel tubes Ø 25 mm, vertical header tubes Ø 38 mm. Delivered ready to install with elegant wall brackets. Standard version with powder coating, in colour RAL 9016, in special colour or chrome on request.

### Electric operation with heating element IHC

Heating element IHC with integrated control function and modular control concept. Basic functions can be set directly on the heating element. For an even more comfortable and easy control, remote control EASY (RCE, available as accessory) or the Zehnder Connect app can be used. Control unit colour in either white, grey or black, depending on radiator colour, built-in on outer collector tube. Connection cable an plug in radiator colour, protection class IP54.

### Electric operation with heating element IHE

Heating element IHE (without control function) for application in combination with on-site control (e. g. BMS systems). Control unit colour either white or chrome, depending on radiator colour, built-in on outer collector tube. Connection cable with Schuko plug in white or grey, protection class IP65.

### Electric operation with heating element RACY-C

Heating element RACY-C, degree of protection IP44 (splash-proof), with Euro plug, installation at bottom left., cover in radiator colour. Separate, battery-operated remote control device model 2 for controlling the room temperature.

## Zehnder Forma Spa

### Overview of models

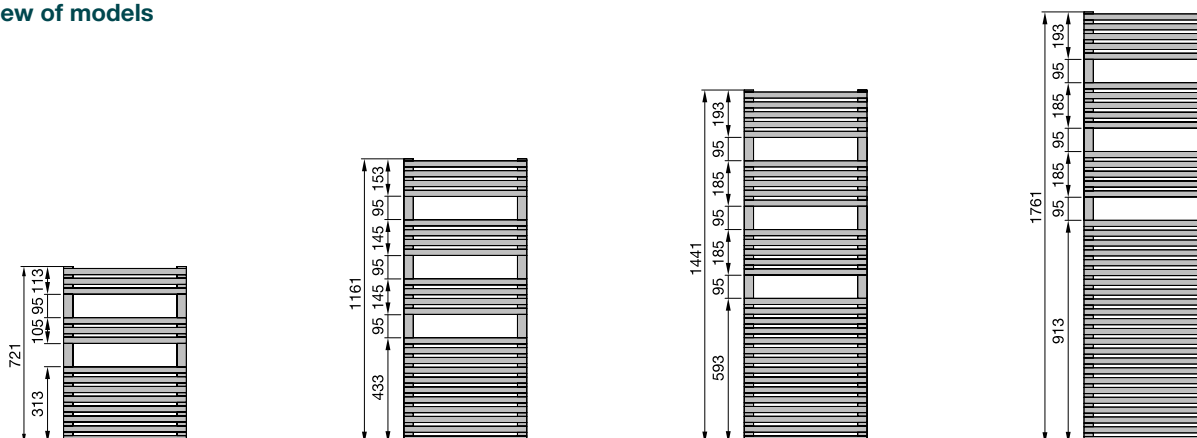

### Connection to hot water central heating system or for dual energy operation<sup>1)</sup>

Model	H mm	L mm	Thermal output				Exp. n	Classification Electric heating element Watt	V dm <sup>3</sup>	M kg	Price RAL 9016 €	Price <sup>①</sup> Cat. 1 €
			EN 442 <sup>③</sup> W	70/55/24 W	55/45/24 W	55/45/20 W						
<b>Painted version, single-layer version, connection central 50 mm</b>												
LF-070-050-05	721	496	378	270	166	199	1,24	300	4,2	7,4	<b>346,01</b>	<b>432,51</b>
LF-120-050-05	1161	496	612	437	269	322	1,24	600	6,8	12,1	<b>414,30</b>	<b>517,87</b>
LF-150-050-05	1441	496	796	570	352	422	1,23	600	8,7	15,6	<b>480,43</b>	<b>600,54</b>
LF-180-050-05	1761	496	973	699	433	518	1,22	900	10,9	19,6	<b>571,03</b>	<b>713,78</b>
LF-070-060-05	721	596	442	318	197	235	1,22	300	4,7	8,5	<b>368,08</b>	<b>460,10</b>
LF-120-060-05	1161	596	707	508	315	376	1,22	600	7,7	13,9	<b>467,19</b>	<b>583,98</b>
LF-150-060-05	1441	596	927	668	416	496	1,21	900	9,9	18,0	<b>544,33</b>	<b>680,42</b>
LF-180-060-05	1761	596	1133	814	505	603	1,22	900	12,5	22,6	<b>624,16</b>	<b>780,20</b>
LF-180-075-05	1761	746	1416	1018	631	754	1,22	1200	14,8	26,8	<b>710,91</b>	<b>888,64</b>
<b>Painted version, double-layer version, connection central 50 mm</b>												
LFD-120-050-05	1161	496	855	604	370	444	1,25	-	10,8	19,9	<b>565,30</b>	<b>706,63</b>
LFD-150-050-05	1441	496	1065	776	474	569	1,26	-	14,3	26,3	<b>680,00</b>	<b>850,00</b>
LFD-180-050-05	1761	496	1298	923	563	677	1,26	-	17,9	32,6	<b>808,22</b>	<b>1.010,28</b>
LFD-120-060-05	1161	596	1017	721	442	530	1,25	-	12,6	23,1	<b>631,78</b>	<b>789,73</b>
LFD-180-060-05	1761	596	1543	1091	666	800	1,26	-	20,8	38,0	<b>931,38</b>	<b>1.164,23</b>

<sup>①</sup> For special colours in categories 1 and 2, see "Special solutions" and "Colour chart"

<sup>③</sup> Thermal output to EN 442, ΔT 50 K (75/65/20°C)

## Zehnder Forma Spa

### Connection to hot water central heating system or for dual energy operation<sup>1)</sup>

Model	H mm	L mm	Thermal output				Exp. n	Classification Electric heating element Watt	V dm <sup>3</sup>	M kg	Price RAL 9016 €	Price <sup>①</sup> Cat. 1 €
			EN 442 <sup>③</sup> W	70/55/24 W	55/45/24 W	55/45/20 W						

#### Painted version, single-layered version, connection from bottom

LF-070-050	721	496	378	270	166	199	1,24	300	4,2	7,0	295,61	363,65
LF-120-050	1161	496	612	437	269	322	1,24	300	6,8	12,1	359,10	448,87
LF-150-050	1441	496	796	422	352	422	1,24	600	8,8	15,7	437,60	547,01
LF-180-050	1761	496	973	699	433	518	1,24	900	11,0	19,6	523,38	636,06
LF-070-060	721	596	442	318	197	235	1,23	300	4,7	8,5	311,23	389,04
LF-120-060	1161	596	707	508	315	376	1,24	600	7,8	14,0	413,37	509,82
LF-150-060	1441	596	927	668	416	496	1,24	900	10,0	18,0	480,38	600,47
LF-180-060	1761	596	1133	814	505	603	1,24	900	12,5	22,6	559,31	699,14
LF-180-075	1761	746	1416	1018	631	754	1,24	1200	14,8	27,1	642,50	803,13

#### Painted version, double-layered version, connection from bottom

LFD-120-050	1161	496	855	604	370	444	1,25	-	10,8	19,9	518,23	647,79
LFD-150-050	1441	496	1065	776	474	569	1,26	-	14,3	26,3	650,15	812,69
LFD-180-050	1761	496	1285	923	563	677	1,26	-	17,9	32,6	763,13	939,24
LFD-120-060	1161	596	1017	721	442	530	1,25	-	12,6	23,1	578,48	723,11
LFD-180-060	1761	596	1543	1091	666	800	1,26	-	20,8	38,0	867,43	1.084,28

Model	H mm	L mm	Thermal output				Exp. n	Classification Electric heating element Watt	V dm <sup>3</sup>	M kg	Price Chrome €
			EN 442 <sup>③</sup> W	70/55/24 W	55/45/24 W	55/45/20 W					

#### Chrome-plated version, connection central 50 mm

LFC-070-050-05	721	496	254	181	111	133	1,28	300	4,2	7,4	556,09
LFC-120-050-05	1161	496	402	283	170	205	1,30	300	6,8	12,1	816,39
LFC-150-050-05	1441	496	512	362	219	264	1,25	300	8,7	15,6	1.050,22
LFC-180-050-05	1761	496	636	447	269	325	1,29	600	10,9	19,6	1.288,22
LFC-120-060-05	1161	596	464	333	207	247	1,25	300	7,7	13,9	938,08
LFC-180-060-05	1761	596	744	522	312	378	1,29	600	12,4	22,6	1.440,42

Model	H mm	L mm	Thermal output				Exp. n	Classification Electric heating element Watt	V dm <sup>3</sup>	M kg	Price Chrome €
			EN 442 <sup>③</sup> W	70/55/24 W	55/45/24 W	55/45/20 W					

#### Chrome-plated version, connection from bottom

LFC-070-050	721	496	254	181	110	132	1,24	300	4,2	7,4	533,49
LFC-120-050	1161	496	402	283	170	205	1,24	300	6,8	12,1	790,78
LFC-150-050	1441	496	512	362	219	264	1,25	300	8,8	15,7	1.012,38
LFC-180-050	1761	496	636	447	269	325	1,24	600	11,0	19,6	1.254,18
LFC-120-060	1161	596	516	371	230	275	1,25	300	7,8	14,0	909,13

<sup>1)</sup> Maximum operating pressure for dual energy operation: 4 bar

<sup>①</sup> For special colours in categories 1 and 2, see "Special solutions" and "Colour chart"

<sup>③</sup> Thermal output to EN 442, ΔT 50 K (75/65/20°C)

## Zehnder Forma Spa

### Connection to hot water central heating & open heating system or for dual energy operation<sup>1)</sup>

Model	H mm	L mm	Thermal output			Exp. n	Classification Electric heating element Watt	V dm <sup>3</sup>	M kg	Price Stainless steel €
			EN 442 <sup>③</sup> W	70/55/24 W	55/45/24 W					

#### Stainless steel version, connection from bottom - adaptable to open heating systems

LFI-070-050	721	496	267	190	116	140	1,25	-	4,3	6,3	<b>847,40</b>
LFI-120-050	1161	496	430	305	159	224	1,26	300	6,9	10,5	<b>1.215,78</b>
LFI-150-050	1441	496	546	386	233	282	1,28	600	8,9	13,5	<b>1.492,22</b>
LFI-180-050	1761	496	683	482	292	352	1,28	600	11,1	16,9	<b>1.778,28</b>
LFI-120-060	1161	596	493	350	213	257	1,26	300	7,9	12,0	<b>1.329,38</b>



### Electric-only operation with new electric platform

Model	H <sup>④</sup> mm	L mm	Classification Electric heating element Watt	Price RAL 9016 €		Price Cat. 1 <sup>①</sup> €	
				Heating element IHC (C)	Heating element IHE (A)	Heating element IHC (C)	Heating element IHE (A)

#### Painted version

LFZSS070050E_ZD	721	496	300	<b>838,61</b>	<b>464,54</b>	<b>1.048,26</b>	<b>580,67</b>
LFZSS120050E_ZD	1161	496	600	<b>908,99</b>	<b>572,79</b>	<b>1.136,24</b>	<b>715,99</b>
LFZSS180050E_ZD	1761	496	900	<b>1.152,21</b>	<b>765,34</b>	<b>1.440,26</b>	<b>956,68</b>
LFZSS120060E_ZD	1161	596	600	<b>944,22</b>	<b>615,19</b>	<b>1.180,28</b>	<b>768,99</b>
LFZSS180060E_ZD	1761	596	1200	<b>1.197,36</b>	<b>845,83</b>	<b>1.496,70</b>	<b>1.057,29</b>

Model	H <sup>④</sup> mm	L mm	Classification Electric heating element Watt	Price Chrome €	
				Heating element IHC (C)	Heating element IHE (A)

#### Chrome-plated version

LFZCS120050E_ZD	1161	496	300	<b>1.175,03</b>	<b>995,76</b>
LFZCS180050E_ZD	1761	496	600	<b>1.663,92</b>	<b>1.471,75</b>

<sup>1)</sup> Maximum operating pressure for dual energy operation: 4 bar

<sup>①</sup> For special colours in categories 1 and 2, see "Special solutions" and "Colour chart"

<sup>②</sup> Thermal output to EN 442,  $\Delta T$  50 K (75/65/20°C)

<sup>④</sup> Total height w/o heating element. For IHC +128 mm, for IHE +50 mm.

For legend, see "Electric operation and Ecodesign Directive" on page 166

## Zehnder Forma Spa



### Electric-only operation

Model	H <sup>③</sup> mm	L mm	Classification Electric heating element Watt	Price RAL 9016 €	Price <sup>①</sup> Cat. 1 €
-------	----------------------	---------	---	------------------------	-----------------------------------

Painted version					
LFE-070-050/GD	746	496	300	820,85	1.026,06
LFE-120-050/GD	1186	496	500	971,06	1.213,83
LFE-180-050/GD	1786	496	900	1.250,92	1.563,65
LFE-120-060/GD	1186	596	600	1.017,12	1.271,40
LFE-180-060/GD	1786	596	900	1.312,36	1.640,45

Model	H <sup>③</sup> mm	L mm	Classification Electric heating element Watt	Price Chrome €
-------	----------------------	---------	---	----------------------

Chrome-plated version				
LFEC-120-050/GD	1186	496	300	1.203,29
LFEC-180-050/GD	1786	496	600	1.602,95

### Standard scope of delivery for operation on hot water central heating system

- Powder coating to DIN 55900, RAL 9016
- 4 x ½" connections for flow, return, electric heating element
- ½" directional air vent
- Mounting accessories in colour of radiator
- Packaging

### Standard scope of delivery for electric operation

- Powder coating to DIN 55900, RAL 9016
- Filled with heat transfer fluid
- Mounting accessories in colour of radiator
- Packaging
- Version with heating element IHC: With built-in immersion heater in outer manifold and control unit with LED matrix display, control unit white, black or grey (depending on radiator colour), cable and plug in colour of control unit
- Version with heating element IHE: With built-in immersion heater in outer manifold, without control option, control unit in white (if radiator is white ) or chrome (for all other radiator surfaces).
- Version with integrated heating element RACY-C: with remote control device, incl. battery, with selectable operating modes: manual (above room temperature), weekly programme, timer, off.

Special solution on request (surcharge)	Article number	Price €
▪ Special finish to category 2 (surcharge on cat. 1)	7600011640	146,76
▪ Remote control EASY for IHC (RCE)*	887970	133,38
▪ Surface in metal look: stainless-steel look (reduced output approx. 13%)	7600012332	As in Cat. 1
▪ Electric heating element for dual energy operation	-	See p. 152 onwards
▪ Zehnder valves, lockshield valves and connection fittings	-	See p. 159 onwards



Remote control EASY can be ordered as accessory for heating element IHC.

<sup>1)</sup> Maximum operating pressure for dual energy operation: 4 bar  
<sup>①</sup> For special colours in categories 1 and 2, see "Special solutions" and "Colour chart"  
<sup>③</sup> Total height incl. electric heating element

For legend, see "Electric operation and Ecodesign Directive" on page 166

# Zehnder Forma Spa

## Operation on hot water central heating system:

Wall mounting  
Single-layer

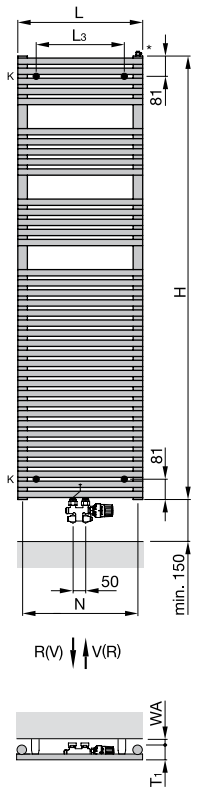

R(V) ↓ V(R)



Wall mounting  
Double-layered

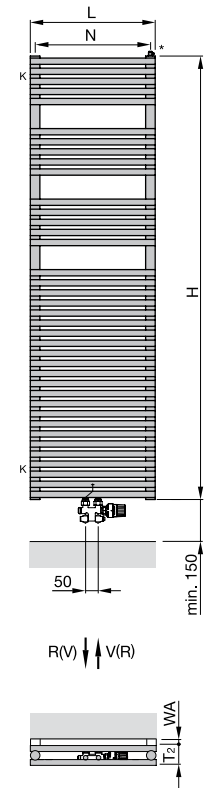

R(V) ↓ V(R)



## Electric operation:

with electric heating element IHC<sup>2)</sup>

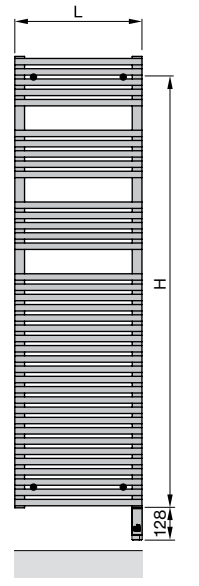
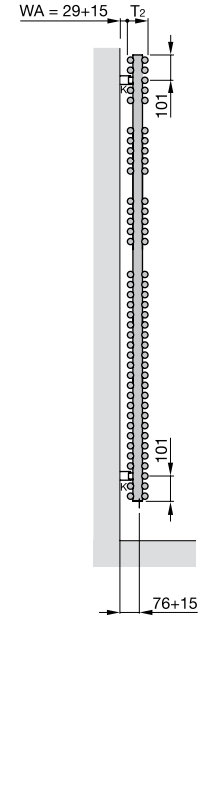

## Dual energy operation<sup>1)</sup>:

Connection to hot water central heating system with electric heating element IHC

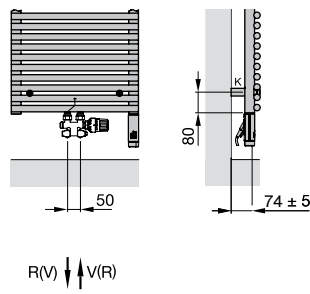

R(V) ↓ V(R)

## Dual energy operation<sup>1)</sup>:

Connection to hot water central heating system with electric heating element IHE

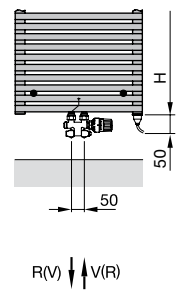

R(V) ↓ V(R)

## Elektrobetrieb:

with electric heating element DBM<sup>3)</sup>

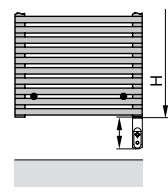

- H = Height
- L = Length
- T<sub>1</sub> = Depth 60 mm
- T<sub>2</sub> = Depth 82 mm
- K = Bracket
- WA = Wall clearance
- V = Flow 1/2"
- R = Return 1/2"
- \* = Venting 1/2"

Dimensions in mm

## Zehnder Fina Lean Bar



Radiator surface: Cream

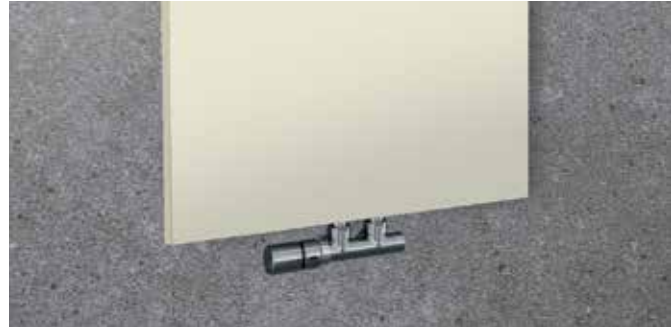

### Operation on central heating system

Zehnder Fina Lean Bar decorative radiator with smooth front panel made of sheet steel in elegant and slim design, even surface and rounded sides for mounting desired towel rails. One towel rail included in scope of delivery. Heat output according to EN 442, with CE marking. With 2 x 1/2" female thread connection for flow/return at bottom centre, spacing 50 mm, air vent 1/2" at top in back. Radiator with powder coating, in colour RAL 9016 as standard, in special colour on request. Delivered ready to install with wall brackets and packaging.

Operating pressure	max. 6.0 bar
Operating temperature	max. 110 °C
Height	..... mm
Length	..... mm
Model	.....

### Benefits

- Slim, elegant design
- Easy to clean due to smooth surface
- Convenient hanging of towels with height-adjustable towel rail in chrome
- Optional: additional towel rail for hanging up more towels
- Pleasant warmth due to high proportion of radiation

### Electric-only operation

Zehnder Fina Lean Bar decorative radiator with smooth front panel made of sheet steel in elegant and slim design, even surface and rounded sides for mounting desired towel rails. One towel rail included in scope of delivery. Radiator with sheet steel on the back side, an inside heating wire and a graphite plate between heating wire and front for even and fast heat distribution. With CE marking. Separate, battery-operated remote control device model 2, heating element RACY-S without visible control components on the radiator. Splash-proof IP44, mains connection 230 V. Connection cable 1.2 m long with Schuko plug. Radiator with powder coating, in colour RAL 9016 as standard, in special colour on request. Delivered ready to install with wall brackets and packaging.

### Standard scope of delivery for operation on central heating system

- Powder coating to DIN 55900, RAL 9016
- Towel rail in chrome
- 2 x 1/2" connections at bottom, centric 50 mm
- 1/2" air vent
- Mounting accessories in colour of radiator
- Packaging

### Special advantages for electric operation RACY-S

- Aesthetically appealing design due to concealed electric heating element
- Flexible control options: control device for wall mounting or base.
- Diverse adjustment options: Regulated room temperature or operation in energy-saving or frost-protection mode
- Customizable daily and weekly programmed for convenient, on-demand operation
- Energy-efficient and comfortable heating with innovative open window detection
- Low energy consumption of only 0.5 W in stand-by mode for increased energy efficiency
- Timer function for on-demand operation. Ready-to-plug for easy and quick installation

## Zehnder Fina Lean Bar

### Overview of models

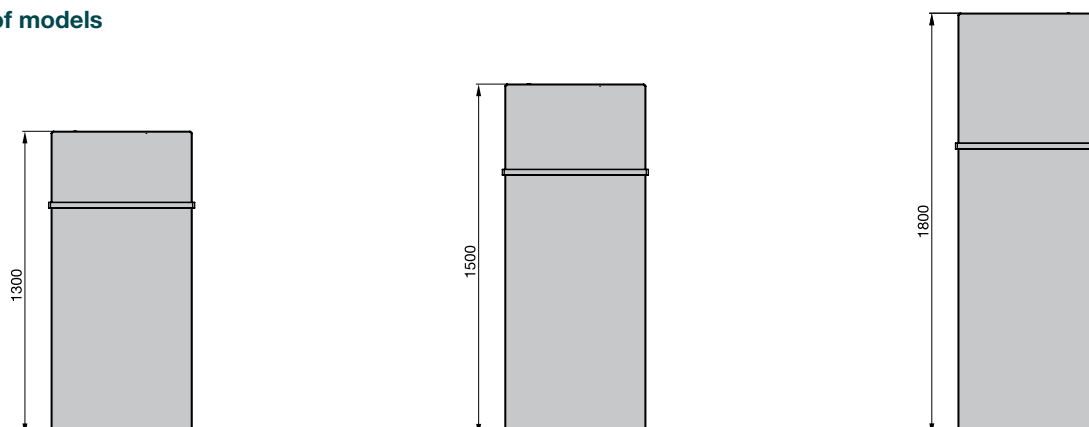

### Connection to hot water central heating system

Model	H mm	L mm	Thermal output				Exp. n	Output electric Watt	V dm <sup>3</sup>	M kg	Price RAL 9016 €	Price <sup>①</sup> Cat. 1 €
			EN 442 <sup>②</sup> W	70/55/24 W	55/45/24 W	55/45/20 W						
<b>Painted version</b>												
<b>FIF-130-050</b>	1300	500	620	444	274	328	1,23	-	0,90	20,9	<b>942,39</b>	<b>1.177,99</b>
<b>FIF-150-050</b>	1500	500	717	516	321	383	1,21	-	1,10	23,7	<b>969,51</b>	<b>1.211,89</b>
<b>FIF-180-050</b>	1800	500	863	619	382	458	1,23	-	1,30	28,7	<b>1.010,18</b>	<b>1.262,73</b>
<b>FIF-130-060</b>	1300	600	723	519	321	384	1,23	-	1,20	24,7	<b>969,51</b>	<b>1.211,89</b>
<b>FIF-150-060</b>	1500	600	837	600	371	444	1,23	-	1,40	28,3	<b>996,63</b>	<b>1.245,79</b>
<b>FIF-180-060</b>	1800	600	1008	719	441	529	1,25	-	1,50	31,4	<b>1.044,08</b>	<b>1.305,10</b>
<b>FIF-130-070</b>	1300	700	824	592	367	439	1,22	-	1,50	28,5	<b>1.023,75</b>	<b>1.279,70</b>
<b>FIF-150-070</b>	1500	700	954	682	420	503	1,24	-	1,70	32,9	<b>1.057,65</b>	<b>1.322,06</b>
<b>FIF-180-070</b>	1800	700	1148	814	495	596	1,27	-	1,80	39,6	<b>1.105,11</b>	<b>1.381,38</b>



### Electric-only operation

Model	H mm	L mm	Output electric Watt	Price RAL 9016 €	Price <sup>①</sup> Cat. 1 €
<b>Painted version</b>					
<b>FIFE-130-050/D</b>	1300	500	350	<b>1.328,84</b>	<b>1.528,16</b>
<b>FIFE-150-050/D</b>	1500	500	500	<b>1.450,88</b>	<b>1.668,50</b>
<b>FIFE-180-050/D</b>	1800	500	500	<b>1.600,03</b>	<b>1.840,03</b>
<b>FIFE-180-060/D</b>	1800	600	750	<b>1.735,62</b>	<b>1.995,96</b>
<b>FIFE-180-070/D</b>	1800	700	750	<b>1.884,78</b>	<b>2.167,50</b>

① For special colours in categories 1 and 2, see special solutions and colour chart

② Thermal output to EN 442,  $\Delta T$  50 K (75/65/20 °C)

For legend, see "Electric operation and Ecodesign Directive" on page 166 [\[1\]](#)

## Zehnder Fina Lean Bar

### Standard scope of delivery for operation on hot water heating system

- Powder coating to DIN 55900, RAL 9016
- Towel rail in chrome plated
- 2 x ½" connections, bottom center 50 mm
- 1 x ½" air vent
- Mounting accessories in colour of radiator
- Packaging

### Standard scope of delivery for electric operation

- Powder coating to DIN 55900, RAL 9016
- Remote control device, incl. battery, with selectable operating modes: manual (above room temperature), weekly programme, timer, off
- Towel rail in chrome plated
- Mounting accessories in colour of radiator
- Packaging

Special solution on request (surcharge)	Article number	Price €
▪ Special finish to category 2 (surcharge on cat. 1)	7600011640	146,76
▪ Towel rail in chrome for radiator length 500 mm	481408	162,72
▪ Zehnder thermostats	-	<b>See page 158</b>
▪ Zehnder valves, return screw connections and connection fittings	-	<b>See p. 159 onwards</b>

# Zehnder Fina Lean Bar

**Operation on central heating system:**  
Wall mounting

Back side

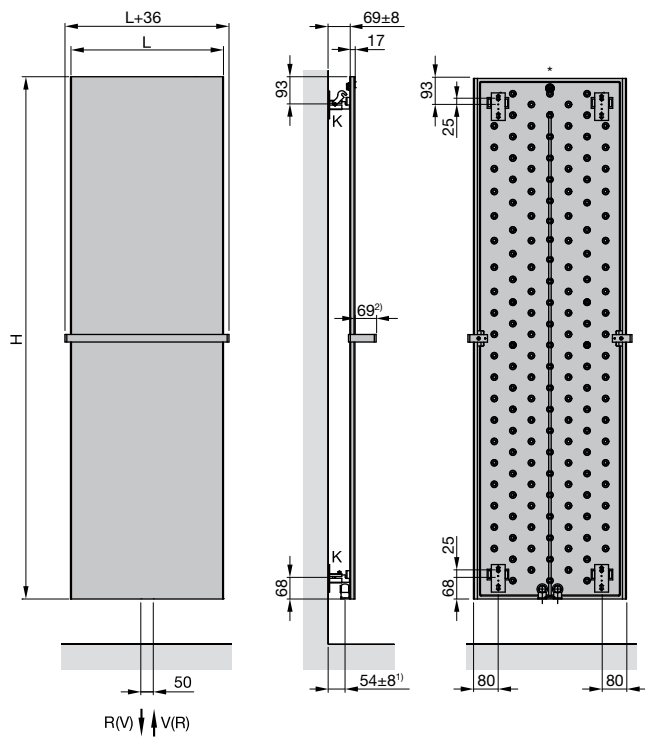

**Electric operation:**  
Wall mounting

Back side

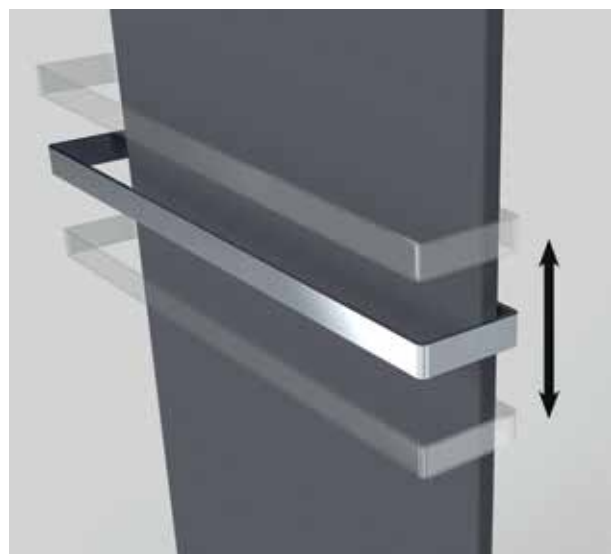
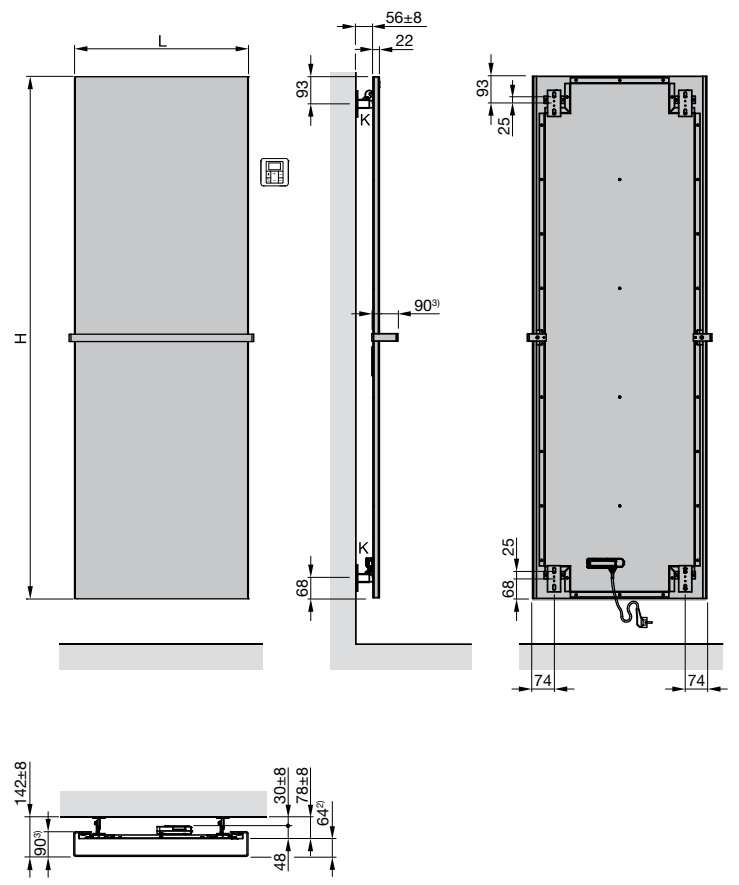

Towel rail is easy to adjust and can be positioned at any height.

**Operation on central heating system:**  
Detail suspension lug

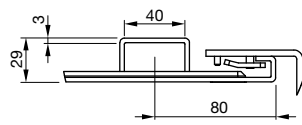

**Electric operation:**  
Detail suspension lug

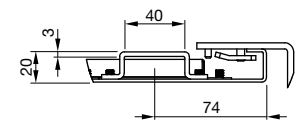

- H = Height
- L = Length
- V = Flow 1/2"
- R = Return 1/2"
- \* = Venting 1/2"
- K = Bracket

Dimensions in mm

- 1) Distance from wall to middle of connection
- 2) Front edge of towel rail to front edge of radiator
- 3) Depth towel rail

## Zehnder Stalox



Radiator surface: Chrome

### Operation on hot water central heating & open heating systems

Zehnder Stalox decorative radiator made from V4A polished stainless steel comprising horizontally arranged round tubes welded with vertical, square manifold tubes. Square manifold tubes 30 x 30 mm, horizontal round tubes Ø 23 mm. Thermal output to EN 422, with CE marking. 2 x 1/2" connection at the ends of the manifold tubes for flow, return and air vent. Delivered ready to install with matching wall brackets in stainless steel look and packaging. Radiator also available with powder coating in colour RAL 9016.

### Benefits

- For open heating system
- Entry-level model suitable for all types of tender businesses
- Small depth
- Flow and return freely selectable
- Classic design with square collectors
- Transparent look

Operating pressure	max. 12 bar
Operating temperature	max. 120 °C
Height	..... mm
Length	..... mm
Model	.....

# Zehnder Stalox

## Overview of models

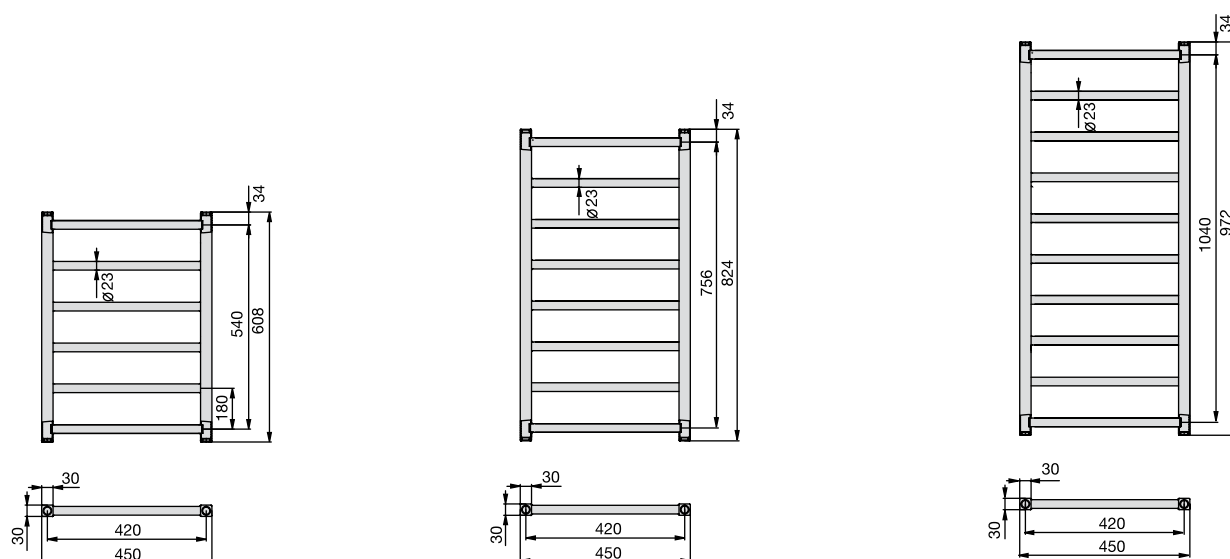

## Connection to hot water central heating and open heating systems

Model	H mm	L mm	Thermal output				Exp. n	Classification Electric heating element Watt	V dm <sup>3</sup>	M kg	Price RAL 9016 €
			EN 442 <sup>Ⓞ</sup> W	70/55/24 W	55/45/24 W	55/45/20 W					

### Painted version

<b>STX-060-045</b>	608	450	190	145	83	102	1,20	-	1,7	3,4	<b>459,48</b>
<b>STX-080-045</b>	824	450	247	189	108	133	1,20	-	2,3	4,5	<b>512,93</b>
<b>STX-100-045</b>	1040	450	310	237	135	166	1,21	300	2,8	5,6	<b>612,31</b>

Model	H mm	L mm	Thermal output				Exp. n	Classification Electric heating element Watt	V dm <sup>3</sup>	M kg	Price Stainless steel €
			EN 442 <sup>Ⓞ</sup> W	70/55/24 W	55/45/24 W	55/45/20 W					

### High gloss stainless steel version

<b>STXI-060-045</b>	608	450	125	96	55	68	1,17	-	1,6	3,7	<b>654,89</b>
<b>STXI-080-045</b>	824	450	167	128	73	88	1,25	-	2,2	4,9	<b>754,30</b>
<b>STXI-100-045</b>	1040	450	209	160	91	109	1,26	-	2,6	6,3	<b>887,39</b>

## Standard scope of delivery for hot water central heating & open heating system

- High gloss stainless steel or on powder coating to DN55900, RAL 9016 on request
- 2 x ½" connections at bottom on the manifold tube
- Air vent ¼"
- Mounting accessories in stainless steel look
- Packaging

Special solution on request (surcharge)	Article number	Price €
▪ Electric heating element for dual energy operation	-	See p. 152 onwards
▪ Zehnder valves, lockshield valves and connection fittings	-	See p. 159 onwards

Ⓞ Thermal output measured according to EN 442, ΔT 50 K (75/65/20 °C)

For legend, see "Electric operation and Ecodesign Directive" on page 166

## Zehnder Toga



Radiator surface: Chrome



Radiator colour: Beach Gold

Radiator colour: Traffic White



### Operation on hot water central heating system

Zehnder Toga decorative radiator made from horizontally arranged precision steel tubes with vertical, fully welded D-profile tubes and invisible welds due to laser welding technology. Round tube Ø 23 mm, D-tube 30 x 35 mm.

Thermal output tested to EN 422, with CE marking.

Flow/return connection in centre ½" or outside left and right ½", connection 50 mm for connection fitting, connection for electric heating element 2 x ½" at bottom on D-profile tube; air vent to top ¼". Radiator with powder coating, in colour RAL 9016 as standard, in special colour on request.

Delivered ready to install with matching wall brackets, packaging.

Operating pressure	max. 11.5 bar
Operating temperature	max. 110 °C
Height	..... mm
Length	..... mm
Model	.....

### Benefits

- Harmonious design through D-profile of vertical tubes
- Can be used as a room divider
- Large cut-outs
- High output due to internal tube design
- Wide range of models
- Top-grade chrome finish
- Easy access connection possible
- Versions for retrofitting

### Electric operation

Zehnder Toga designer radiator, electric-only, made from horizontally arranged precision steel tubes with vertical, fully welded D-profile tubes and invisible welds due to laser welding technology. Delivered ready to install with elegant wall brackets. Standard version with powder coating in colour RAL 9016, in special colour or chrome on request, with packaging.

### Electric operation with heating element IHC

Heating element IHC with integrated control function and modular control concept. Basic functions can be set directly on the heating element. For an even more comfortable and easy control, remote control EASY (RCE, available as accessory) or the Zehnder Connect app can be used. Control unit colour in either white, grey or black, depending on radiator colour, built-in on right collector tube. Connection cable an plug in radiator colour, protection class IP54.

### Electric operation with heating element IHE

Heating element IHE (without control function) for application in combination with on-site control (e. g. BMS systems). Control unit colour either white or chrome, depending on radiator colour, built-in on right collector tube. Connection cable with Schuko plug in white or grey, protection class IP65.

### Electric operation with heating element RACY-C

Heating element RACY-C, degree of protection IP44 (splash-proof), with Euro plug, installation at bottom left, cover in radiator colour. Separate, battery-operated remote control device model 2 for controlling the room temperature.

# Zehnder Toga

## Overview of models

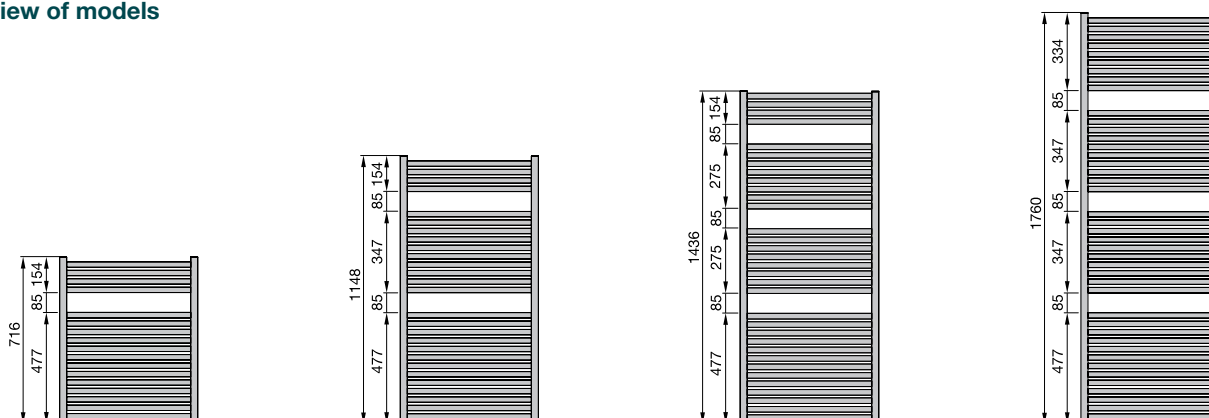

## Connection to hot water central heating system or for dual energy operation<sup>1)</sup>

Model	H mm	L mm	Thermal output				Exp. n	Classification Electric heating element Watt	V dm <sup>3</sup>	M kg	Price RAL 9016 €	Price <sup>Ⓞ</sup> Cat. 1 €
			EN 442 <sup>Ⓢ</sup> W	70/55/24 W	55/45/24 W	55/45/20 W						
<b>Painted version, connection from below</b>												
TG-070-045	716	450	347	249	154	184	1,20	300	3,4	6,2	272,06	340,07
TG-120-045	1148	450	539	385	237	284	1,22	300	5,5	9,7	331,79	414,74
TG-180-045	1760	450	823	588	362	434	1,25	600	8,4	16,3	463,19	578,98
TG-070-050	716	500	381	273	169	202	1,20	300	3,7	6,7	297,66	372,07
TG-120-050	1148	500	592	423	260	312	1,22	300	6,0	10,5	343,71	429,63
TG-150-050	1436	500	736	527	326	386	1,24	600	7,3	13,1	451,61	564,51
TG-180-050	1760	500	904	646	397	476	1,25	600	9,1	17,3	476,85	596,07
TG-070-060	716	600	449	323	200	239	1,20	300	4,3	7,8	331,79	414,74
TG-120-060	1148	600	696	497	306	367	1,22	600	6,9	12,0	357,40	446,75
TG-150-060	1436	600	866	621	383	454	1,24	600	8,5	14,8	477,42	596,78
TG-180-060	1760	600	1063	762	470	563	1,25	900	10,6	19,4	493,93	617,40
TG-120-075	1148	750	849	608	376	450	1,22	600	8,6	13,9	391,51	489,39
TG-180-075	1760	750	1297	932	578	690	1,24	1200	12,8	22,5	540,01	675,01
TG-180-100	1760	1000	1675	1210	756	901	1,22	1200	16,5	27,7	594,55	743,20

Model	H mm	L mm	Thermal output				Exp. n	Classification Electric heating element Watt	V dm <sup>3</sup>	M kg	Price RAL 9016 €	Price <sup>Ⓞ</sup> Cat. 1 €
			EN 442 <sup>Ⓢ</sup> W	70/55/24 W	55/45/24 W	55/45/20 W						
<b>Painted version, connection central 50 mm</b>												
TG-070-045-05	716	450	347	249	154	184	1,20	300	3,4	6,5	344,72	430,90
TG-120-045-05	1148	450	539	385	237	284	1,22	300	5,5	10,0	404,46	505,59
TG-180-045-05	1760	450	823	588	362	434	1,25	600	8,4	16,6	535,87	669,84
TG-070-050-05	716	500	381	273	169	202	1,20	300	3,7	7,0	370,32	462,90
TG-120-050-05	1148	500	592	423	260	312	1,22	300	6,0	10,8	416,41	520,51
TG-150-050-05	1436	500	736	527	326	386	1,24	600	7,3	13,4	515,41	644,27
TG-180-050-05	1760	500	904	646	397	476	1,25	600	9,1	17,6	549,51	686,89
TG-070-060-05	716	600	449	323	200	239	1,20	300	4,3	8,1	404,46	505,59
TG-120-060-05	1148	600	696	497	306	367	1,22	600	6,9	12,3	430,07	537,60
TG-150-060-05	1436	600	866	621	383	454	1,24	600	8,5	15,1	530,75	663,44
TG-180-060-05	1760	600	1063	762	470	563	1,25	900	10,6	19,7	566,55	708,19
TG-120-075-05	1148	750	849	608	376	450	1,22	600	8,6	14,2	464,21	580,25
TG-180-075-05	1760	750	1297	932	578	690	1,24	1200	12,8	22,8	612,65	765,82
TG-180-100-05	1760	1000	1675	1210	756	901	1,22	1200	16,5	28,0	667,27	834,09

<sup>1)</sup> Maximum operating pressure for dual energy operation: 4 bar

<sup>Ⓞ</sup> For special colours in categories 1 and 2, see "Special solutions" and "Colour chart"

<sup>Ⓢ</sup> Thermal output measured according to EN 442, ΔT 50 K (75/65/20 °C)

## Zehnder Toga

### Connection to hot water central heating system or for dual energy operation<sup>1)</sup>

Model	H mm	L mm	Thermal output			Exp. n	Classification Electric heating element Watt	V dm <sup>3</sup>	M kg	Price Chrome €
			EN 442 <sup>2)</sup> W	70/55/24 W	55/45/24 W					
<b>Chrome-plated version, connection from bottom</b>										
TGC-070-050	716	500	240	169	101	1,30	300	3,7	6,7	<b>968,92</b>
TGC-120-050	1148	500	379	267	160	1,30	300	5,8	10,5	<b>1.142,02</b>
TGC-150-050	1436	500	478	335	201	1,31	300	7,4	13,1	<b>1.380,89</b>
TGC-180-050	1760	500	596	419	252	1,30	300	9,3	17,3	<b>1.508,17</b>
TGC-120-060	1148	600	451	317	190	1,30	300	6,9	12,0	<b>1.224,13</b>
TGC-180-060	1760	600	709	499	299	1,30	600	10,8	19,4	<b>1.615,42</b>

### Electric-only operation with new electric platform



Model	H <sup>3)</sup> mm	L mm	Classification Electric heating element Watt	Price RAL 9016 €		Price Cat. 1 <sup>1)</sup> €	
				Heating element IHC (C)	Heating element IHE (A)	Heating element IHC (C)	Heating element IHE (A)
<b>Painted version</b>							
TGZSS070050E_ZD	716	500	300	<b>629,81</b>	<b>419,79</b>	<b>715,38</b>	<b>501,64</b>
TGZSS120050E_ZD	1148	500	600	<b>694,27</b>	<b>475,62</b>	<b>793,07</b>	<b>570,13</b>
TGZSS150050E_ZD	1436	500	600	<b>818,35</b>	<b>594,31</b>	<b>948,19</b>	<b>718,50</b>
TGZSS180050E_ZD	1760	500	900	<b>858,88</b>	<b>632,24</b>	<b>995,98</b>	<b>763,38</b>
TGZSS120060E_ZD	1148	600	600	<b>710,01</b>	<b>490,68</b>	<b>812,76</b>	<b>588,96</b>
TGZSS180060E_ZD	1760	600	900	<b>878,52</b>	<b>651,02</b>	<b>1.020,51</b>	<b>786,84</b>
TGZSS180075E_ZD	1760	750	1200	<b>937,26</b>	<b>722,71</b>	<b>1.092,51</b>	<b>871,21</b>

Model	H <sup>3)</sup> mm	L mm	Classification Electric heating element Watt	Price Chrome €	
				Heating element IHC (C)	Heating element IHE (A)
<b>Chrome-plated version</b>					
TGZCS120050E_ZD	1148	500	400	<b>1.612,32</b>	<b>1.366,22</b>
TGZCS150050E_ZD	1436	500	400	<b>1.887,02</b>	<b>1.628,98</b>
TGZCS180060E_ZD	1760	600	600	<b>2.168,23</b>	<b>1.897,96</b>

<sup>1)</sup> For special colours in categories 1 and 2, see "Special solutions" and "Colour chart"

<sup>2)</sup> Thermal output to EN 442, ΔT 50 K (75/65/20°C)

<sup>3)</sup> Total height w/o heating element. For IHC +128 mm, for IHE +50 mm.

For legend, see "Electric operation and Ecodesign Directive" on page 166

## Zehnder Toga



### Electric-only operation

Model	H <sup>Ⓢ</sup> mm	L mm	Classification Electric heating element Watt	Price RAL 9016 €	Price <sup>Ⓢ</sup> Cat. 1 €
-------	----------------------	---------	---	------------------------	-----------------------------------

#### Painted version

TE-070-050/GD	716	500	300	713,35	820,36
TE-120-050/GD	1148	500	600	846,45	973,42
TE-150-050/GD	1436	500	750	996,63	1.146,13
TE-180-050/GD	1760	500	900	1.090,49	1.254,06
TE-120-060/GD	1148	600	600	872,06	1.002,87
TE-180-060/GD	1760	600	1200	1.138,27	1.309,03
TE-180-075/GD	1760	750	1500	1.274,78	1.466,00

Model	H <sup>Ⓢ</sup> mm	L mm	Classification Electric heating element Watt	Price Chrome €
-------	----------------------	---------	---	----------------------

#### Chrome-plated version

TEC-120-050/GD	1148	500	300	1.836,28
TEC-150-050/GD	1436	500	500	2.177,59
TEC-180-060/GD	1760	600	750	2.467,72

### Standard scope of delivery for operation on hot water central heating system

- Powder coating to DIN 55900, RAL 9016
- 2 x ½" connections for flow, return
- Retrofit model: 2 x ½" at side, 1 x ½" at bottom
- ¼" directional air vent, right
- Mounting accessories in colour of radiator
- Packaging

### Standard scope of delivery for electric operation

- Powder coating to DIN 55900, RAL 9016
- Filled with heat transfer fluid
- Mounting accessories in colour of radiator
- Packaging
- Version with heating element IHC: With built-in immersion heater in outer manifold and control unit with LED matrix display, control unit white, black or grey (depending on radiator colour), cable and plug in colour of control unit
- Version with heating element IHE: With built-in immersion heater in outer manifold, without control option, control unit in white (if radiator is white ) or chrome (for all other radiator surfaces).
- Version with integrated heating element RACY-C: with remote control device, incl. battery, with selectable operating modes: manual (above room temperature), weekly programme, timer, off.

Ⓢ For special colours in categories 1 and 2, see "Special solutions" and "Colour chart"

Ⓢ Total height incl. electric heating element

For legend, see "Electric operation and Ecodesign Directive" on page 166

## Zehnder Toga

Special solution on request (surcharge)	Article number	Price €
▪ Special finish to category 2 (surcharge on cat. 1)	2800011640	146,76
▪ Remote control EASY for IHC (RCE)*	887970	133,38
▪ Surface in metal look: stainless-steel look (reduced output approx. 13%)	2800012332	As in Cat. 1
▪ Use as room divider with separate mounting accessories	-	See page 138
▪ Retrofit model with optional lateral connections (same side or opposite-end)		186,33
▪ Electric heating element and T-piece for dual energy operation	-	See p. 152 onwards
▪ Accessories	-	See page 145
▪ Lambswool cleaning brush	601040	60,41
▪ Zehnder valves, lockshield valves and connection fittings	-	See p. 159 onwards
▪ Wall mounting accessories for extended wall clearance up to 130 mm, white	952021	117,37

### Operation on hot water central heating system:

#### Wall mounting

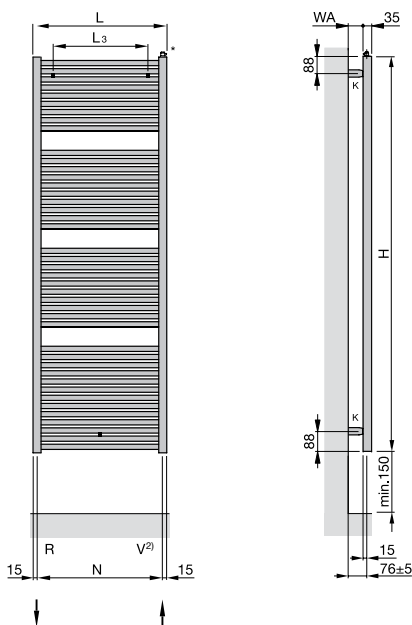

#### Room divider installation

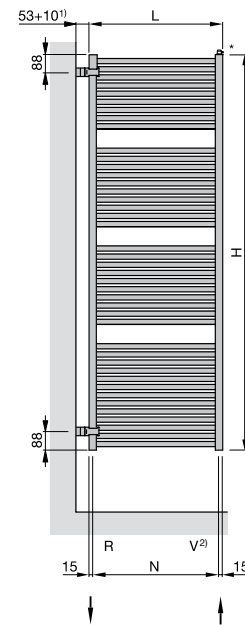

#### Retrofit model, connections left

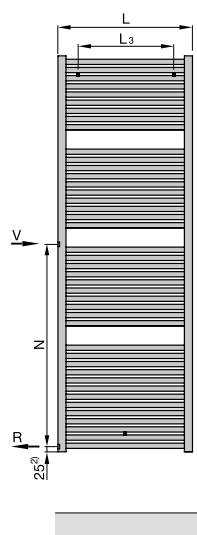

### Electric operation:

#### with heating element IHC

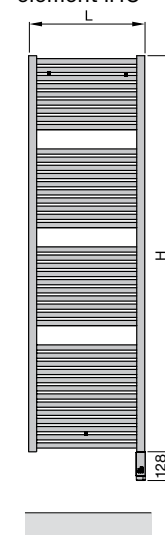

### Dual energy operation:

Connection to hot water central heating system with electric heating element (fig. with IHE) and T-piece in return

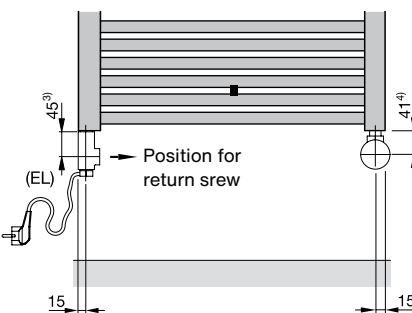

- H = Height
- L = Length
- EL = Connection for electric heating element (on return side)
- K = Bracket
- V = Flow 1/2"
- R = Return 1/2"
- \* = Venting 1/4"
- N = Connection centre
- L<sub>3</sub> = Fixing dimension, L - 150 mm
- WA = Wall clearance 59 ± 5 mm

Dimensions in mm

### Electric operation:

#### with heating element RACY-C

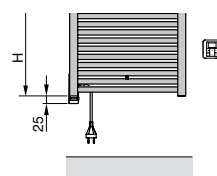

- 1) Extension to 103 mm possible with room divider mounting set for increased wall distance, see page 138.
  - 2) For custom boss spacing, return connection 34 mm from bottom
  - 3) Measurement valid for T-piece long; changes do 20 mm when using T-piece short
  - 4) Measurement for Design Line Valve type B
  - 5) Changing flow and return possible when changing the dip tube from right to left
- For legend, see "Electric operation and Ecodesign Directive" on page 166



Remote control EASY can be ordered as accessory for heating element IHC.

## Zehnder Zeta



Radiator colour: Traffic White



Radiator surface: Chrome / Zeta Black Matt with Musa Eco

### Connecting to hot water central heating system

Subtle elegance and clear lines. With the flat design of its horizontal tube elements 60 x 9 mm, Zehnder Zeta combines form and function in the bathroom. The generous clearance between the sets of tubes makes hanging and warming towels easy. The radiator is available in white and with a quality chrome finish.

Maximum operating pressure	max. 4.0 bar
Operating temperature	max. 90 °C
Height	..... mm
Length	..... mm
Model	.....

### Benefits

- Radiator with flat design
- Flexible installation through right and left connection options

### Standard scope of delivery

- Powder coating to DIN 55900, RAL 9016
- 4 x 1/2" connections for flow/ return, air vents
- 1 x blind plug 1/2"
- 1 x air vent 1/2"
- Accessories in colour of radiator
- Packaging

### Electric-only operation

Subtle elegance and clear lines. With the flat design of its horizontal tube elements 60 x 9 mm, Zehnder Zeta combines form and function in the bathroom. The generous clearance between the sets of tubes makes hanging and warming towels easy. With built-in electric heating element Musa Eco. Protection class IP 44 (splash-proof), for mains power supply of 230 V. Connection cable (1,3 m) with Euro plug.

Installation at bottom right. Decorative radiator filled with heat transfer fluid.

Delivered ready to install with elegant wall brackets. Standard version with powder coating, in colour RAL 9016, black matt or chrome finish.

### Benefits

- High energy efficiency due to compliance with the European Ecodesign Directive reduces energy costs
- User-friendly control device allows simple operation
- Customisable daily and weekly programmes for convenient, on-demand operation
- Increased safety with keylock

### Standard scope of delivery

- Powder coating to DIN 55900, RAL 9016
- Filled with heat transfer liquid
- With integrated electric heating element MUSA Eco with seven operational modes: comfort, night, anti-freeze, fil-pilot, chrono, timer- 2h, stand-by, right-mounted
- Mounting accessories in colour of radiator
- Packaging

# Zehnder Zeta

## Overview of models

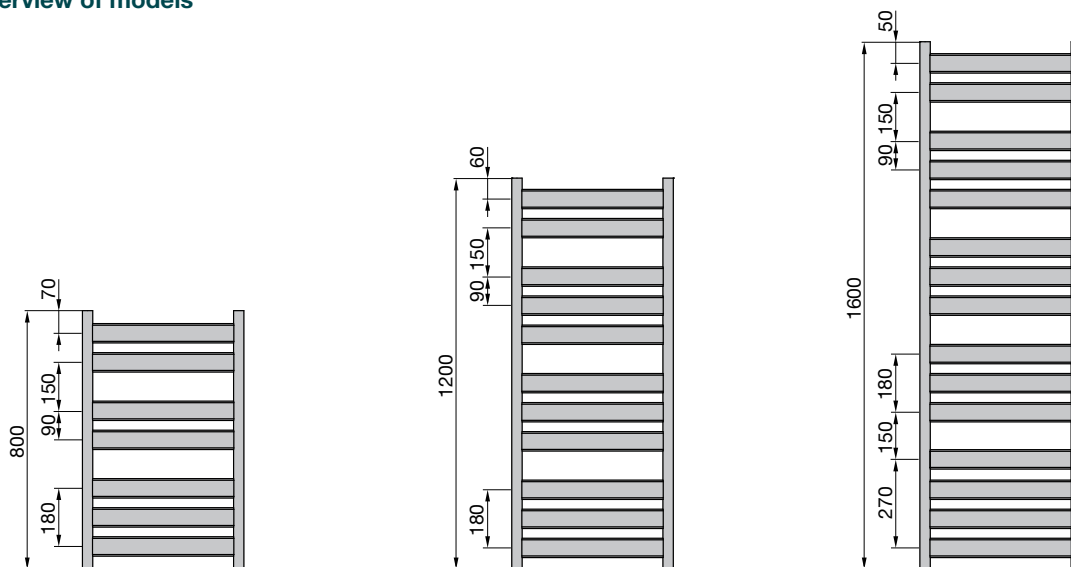

## Connection to hot water central heating system

Model	H mm	L mm	Thermal output			Exp. n	Classification Electric heating element Watt	V dm <sup>3</sup>	M kg	Price RAL 9016 €
			EN 442 <sup>Ⓞ</sup> W	70/55/24 W	55/45/24 W					

Painted version (White RAL 9016)											
ZET-080-050	800	500	322	230	141	170	1,24	300	2,2	6,4	263,43
ZET-120-050	1200	500	476	340	209	253	1,24	300	3,7	10,1	335,27
ZET-160-050	1600	500	647	463	285	340	1,23	600	4,6	13,3	423,58
ZET-080-060	800	600	377	271	168	201	1,22	300	2,6	7,4	279,88
ZET-120-060	1200	600	566	405	249	298	1,22	300	4,4	11,3	360,73
ZET-160-060	1600	600	746	533	328	397	1,23	600	5,5	15,3	463,97

Model	H mm	L mm	Thermal output			Exp. n	Classification Electric heating element Watt	V dm <sup>3</sup>	M kg	Price Anthracite €
			EN 442 <sup>Ⓞ</sup> W	70/55/24 W	55/45/24 W					

Painted version (Black matt RAL 9205)											
ZET-120-050-9205	1200	500	476	340	209	253	1,24	300	3,7	10,1	368,98

Model	H mm	L mm	Thermal output			Exp. n	Classification Electric heating element Watt	V dm <sup>3</sup>	M kg	Price Chrome €
			EN 442 <sup>Ⓞ</sup> W	70/55/24 W	55/45/24 W					

Chrome-plated version											
ZETC-080-050	800	500	203	144	88	106	1,26	-	2,2	6,4	428,05
ZETC-120-050	1200	500	303	214	130	156	1,28	300	3,7	10,0	526,86
ZETC-160-050	1600	500	394	279	169	205	1,27	300	4,6	13,2	670,53
ZETC-080-060	800	600	235	168	103	123	1,25	-	2,6	7,4	453,51
ZETC-120-060	1200	600	353	250	151	183	1,27	300	4,4	11,4	571,74
ZETC-160-060	1600	600	457	322	194	237	1,28	300	5,5	15,3	727,39

Ⓞ Thermal output measured according to EN 442, ΔT 50 K (75/65/20 °C)

## Zehnder Zeta

### Electric only operation with Musa Eco

Model	H mm	L mm	Classification Electric heating element Watt	V dm <sup>3</sup>	M kg	Price RAL 9016 €
-------	---------	---------	---	----------------------	---------	------------------------

#### Painted version (White RAL 9016)

ZETE-080-050/MQ	800	500	300	3,2	8,9	<b>367,57</b>
ZETE-095-050/MQ	950	500	400	3,5	10,7	<b>400,40</b>
ZETE-120-050/MQ	1200	500	500	4,6	13,7	<b>442,28</b>
ZETE-120-060/MQ	1200	600	600	5,5	15,3	<b>468,76</b>
ZETE-160-060/MQ	1600	600	750	7,0	20,5	<b>576,13</b>

Model	H mm	L mm	Classification Electric heating element Watt	V dm <sup>3</sup>	M kg	Price RAL 9205 €
-------	---------	---------	---	----------------------	---------	------------------------

#### Painted version (Black matt RAL 9205)

ZETBE-080-050/MQ-9205	800	500	300	3,2	8,9	<b>395,20</b>
ZETBE-095-050/MQ-9205	950	500	400	3,5	10,7	<b>431,60</b>
ZETBE-120-050/MQ-9205	1200	500	500	4,6	13,7	<b>477,34</b>
ZETBE-160-060/MQ-9205	1600	600	750	7,0	20,5	<b>624,00</b>

Model	H mm	L mm	Classification Electric heating element Watt	V dm <sup>3</sup>	M kg	Price Chrome €
-------	---------	---------	---	----------------------	---------	----------------------

#### Chrome-plated version

ZETCE-080-050/MQ	800	500	150	3,2	8,9	<b>538,77</b>
ZETCE-095-050/MQ	950	500	200	3,5	10,8	<b>577,20</b>
ZETCE-120-050/MQ	1200	500	300	4,6	13,7	<b>641,53</b>
ZETCE-120-060/MQ	1200	600	300	5,5	15,4	<b>688,21</b>
ZETCE-160-060/MQ	1600	600	400	7,0	20,6	<b>850,09</b>



# Zehnder Virando



Radiator surface: Beach Gold

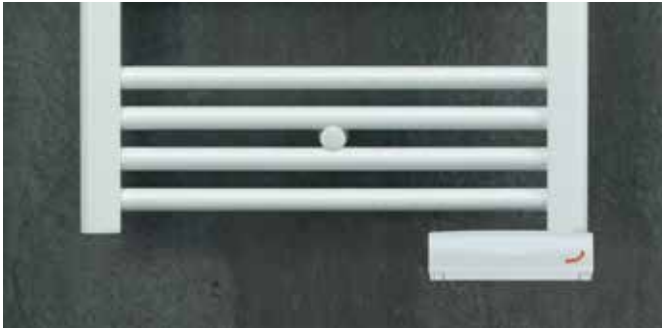

Radiator for electric operation with TIMERMEMO

### Hot water operation

Clarity and class. Zehnder Virando has what any lover of modern style looks for. A clear design, with horizontal and straight tube elements allows for ample space for hanging towels. Zehnder Virando designer radiator made from horizontally arranged precision steel tubes with vertical D-profile tubes. Round tubes Ø 23 mm, D-tubes 30 x 40 mm. Available in almost any colour and finish from the Zehnder colour chart. Delivered ready to install with matching wall brackets, packaging.

Maximum operating pressure	max. 12 bar
Operating temperature	max. 120 °C
Height	..... mm
Length	..... mm
Model	.....

### Benefits

- Timeless design creates an aesthetic accent
- Generous spaces between the tubes convenient for hanging towels
- Top-grade chrome finish
- Ample spaces between tubes make cleaning easy
- Flexible installation due to 50 mm centre connections

### Special benefits for electric operation with TIMERMEMO

- Energy-efficient and comfortable heating via innovative “open window detection”
- Low energy consumption of only 0,5 W in stand-by mode for increased energy efficiency
- Operation by smartphone with Zehnder Control app
- Comfortable operation as needed by customisable daily and weekly programme
- Timer function for on-demand operation
- With flying lead to connect in accordance with local electrical regulations



# Zehnder Virando

## Overview of models

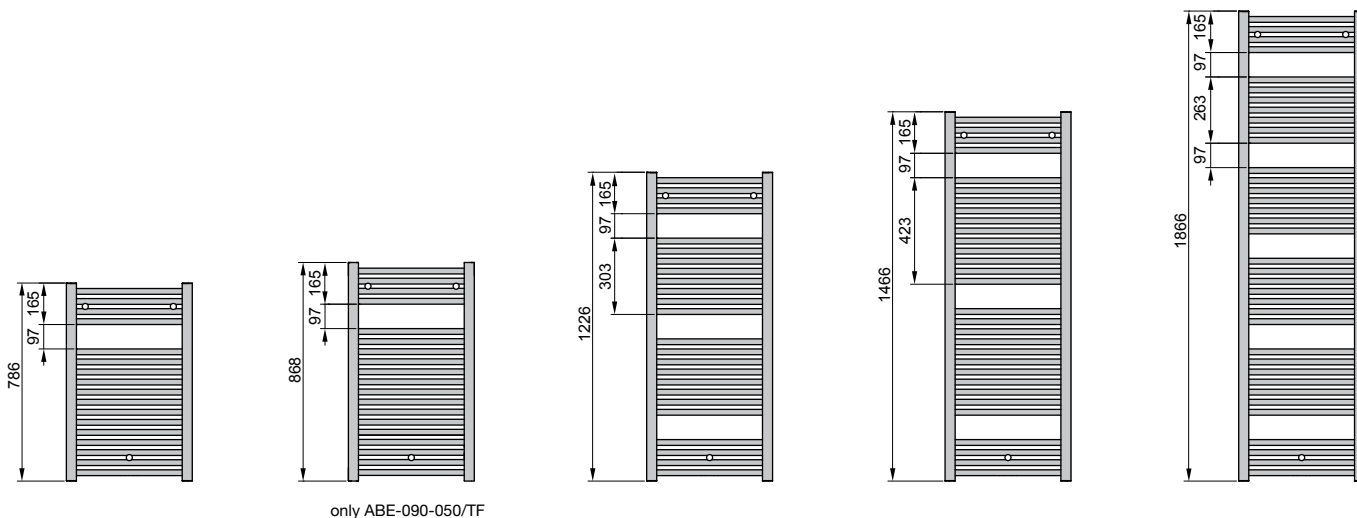

only ABE-090-050/TF

## Connection to hot water central heating system or for dual energy operation

Model	H mm	L mm	Thermal output			Exp. n	Classification Electric heating element Watt	V dm <sup>3</sup>	M kg	Price RAL 9016 €	Price Cat. 1 €	Price Cat. 2 €
			EN 442 <sup>Ⓢ</sup> W	70/55/24 W	55/45/24 W							

Painted version, connection from bottom													
AB-080-045	786	450	344	244	149	179	1,26	300	3,6	5,6	123,48	152,43	225,81
AB-120-045	1226	450	505	358	218	262	1,27	300	5,3	8,2	175,42	219,28	292,66
AB-080-050	786	500	379	269	164	197	1,26	300	3,9	6,0	130,60	156,89	230,27
AB-120-050	1226	500	552	391	237	286	1,27	300	5,7	9,0	180,79	225,99	299,37
AB-150-050	1466	500	678	481	293	353	1,27	600	7,2	11,0	230,88	288,60	321,33
AB-180-050	1866	500	830	590	360	433	1,26	600	8,7	13,5	230,09	287,62	361,00
AB-080-060	786	600	448	318	194	234	1,26	300	4,6	7,0	142,90	171,70	236,97
AB-120-060	1226	600	648	460	280	337	1,26	600	6,6	10,0	189,69	237,12	310,50
AB-150-060	1466	600	794	565	346	415	1,25	600	8,2	12,7	213,06	261,06	334,44
AB-180-060	1866	600	978	697	427	512	1,25	900	9,9	16,0	252,08	303,05	376,43
AB-120-075	1226	750	791	562	343	412	1,26	600	7,9	12,4	208,04	260,05	333,43
AB-150-075	1466	750	968	691	424	509	1,24	900	9,7	15,2	244,72	305,90	379,28
AB-180-075	1866	750	1230	879	540	648	1,24	900	11,7	18,4	286,22	357,78	431,16

Model	H mm	L mm	Thermal output			Exp. n	Classification Electric heating element Watt	V dm <sup>3</sup>	M kg	Price RAL 9016 €	Price Cat. 1 €	Price Cat. 2 €
			EN 442 <sup>Ⓢ</sup> W	70/55/24 W	55/45/24 W							

Painted version, connection central 50 mm													
AB-080-045-05	786	450	344	244	149	179	1,26	300	3,6	5,9	140,76	175,95	249,33
AB-080-050-05	786	500	379	269	164	197	1,26	300	3,9	6,3	148,56	180,55	253,93
AB-120-050-05	1226	500	552	393	240	288	1,26	300	5,7	9,3	214,22	251,73	325,11
AB-150-050-05	1466	500	678	481	293	353	1,27	600	7,2	11,3	219,47	274,34	347,72
AB-180-050-05	1866	500	830	590	360	433	1,26	600	8,7	13,8	252,13	315,16	388,54
AB-120-060-05	1226	600	648	460	281	337	1,26	600	6,6	10,3	248,60	263,15	336,53
AB-150-060-05	1466	600	794	565	346	415	1,25	600	8,2	13,0	230,22	287,78	361,16
AB-180-060-05	1866	600	978	697	427	512	1,25	900	9,9	16,3	270,04	331,08	404,46

Ⓢ Thermal output measured according to EN 442, ΔT 50 K (75/65/20 °C)

## Zehnder Virando

### Connection to hot water central heating system or for dual energy operation

Model	H mm	L mm	Thermal output			Exp. n	Classification Electric heating element Watt	V dm <sup>3</sup>	M kg	Price Chrome €
			EN 442 <sup>ⓐ</sup> W	70/55/24 W	55/45/24 W					

#### Chrome-plated version, connection from below

ABC-080-050	786	500	277	198	122	146	1,24	-	3,9	6,0	402,68
ABC-120-050	1226	500	403	286	174	209	1,27	300	5,7	9,0	545,88
ABC-150-050	1466	500	483	345	212	254	1,24	300	7,2	11,0	656,30
ABC-180-050	1866	500	606	433	266	319	1,24	600	8,7	14,0	784,68
ABC-080-060	786	600	327	234	144	172	1,24	300	4,6	7,0	454,98
ABC-120-060	1226	600	473	336	205	247	1,26	300	6,6	10,0	620,22
ABC-150-060	1466	600	558	399	245	294	1,24	300	8,2	12,7	750,68
ABC-180-060	1866	600	714	509	312	374	1,25	600	9,9	16,0	897,36

Model	H mm	L mm	Thermal output			Exp. n	Classification Electric heating element Watt	V dm <sup>3</sup>	M kg	Price Chrome €
			EN 442 <sup>ⓐ</sup> W	70/55/24 W	55/45/24 W					

#### Chrome-plated version, connection central 50 mm

ABC-080-050-05	786	500	277	198	122	146	1,24	-	3,9	6,0	434,34
ABC-120-050-05	1226	500	403	286	174	209	1,27	300	5,7	9,0	577,54
ABC-150-050-05	1466	500	483	345	212	254	1,24	300	7,2	11,0	687,92
ABC-180-050-05	1866	500	606	433	266	319	1,24	600	8,7	14,0	816,26
ABC-080-060-05	786	600	327	234	144	172	1,24	300	4,6	7,0	486,64
ABC-120-060-05	1226	600	473	336	205	247	1,26	300	6,6	10,0	651,74
ABC-150-060-05	1466	600	558	399	245	294	1,24	300	8,2	12,7	782,18
ABC-180-060-05	1866	600	714	509	312	374	1,25	600	9,9	16,0	928,90

### Electric-only operation with TIMERMEMO

Model	H <sup>ⓑ</sup> mm	L <sup>ⓒ</sup> mm	Classification Electric heating element Watt	Price RAL 9016 €	Price Cat. 1 €	Price Cat. 2 €
-------	----------------------	----------------------	---	------------------------	----------------------	----------------------

#### Painted version

ABE-090-050/TF	916	509	500	317,99	365,68	439,06
ABE-120-050/TF	1276	509	750	367,08	422,14	495,52
ABE-150-060/TF	1516	609	1000	419,41	482,32	555,70

Available in almost any colour and finish from the Zehnder colour chart, see page 174.  
Control unit TIMERMEMO in white.

#### Standard scope of delivery for hot water operation

- Powder coating to DIN 55900, RAL 9016
- 4 x 1/2" connections for flow, return, air vent and plug
- 1 air vent 1/2" and 1 blind plug 1/2"
- Mounting accessories in colour of radiator
- Packaging

#### Standard scope of delivery for electric operation

- Powder coating to DIN 55900, RAL 9016
- Filled with heat transfer liquid
- With integrated electric heating element and control unit TIMERMEMO in white, right-mounted
- Mounting accessories in colour of radiator
- Packaging

ⓐ Thermal output measured according to EN 442, ΔT 50 K (75/65/20 °C)

ⓑ Total height incl. immersion heater

ⓒ Total length incl. immersion heater

# Zehnder Virando

**Hot water operation:**  
Wall mounting

Wall mounting  
centre connections 50 mm

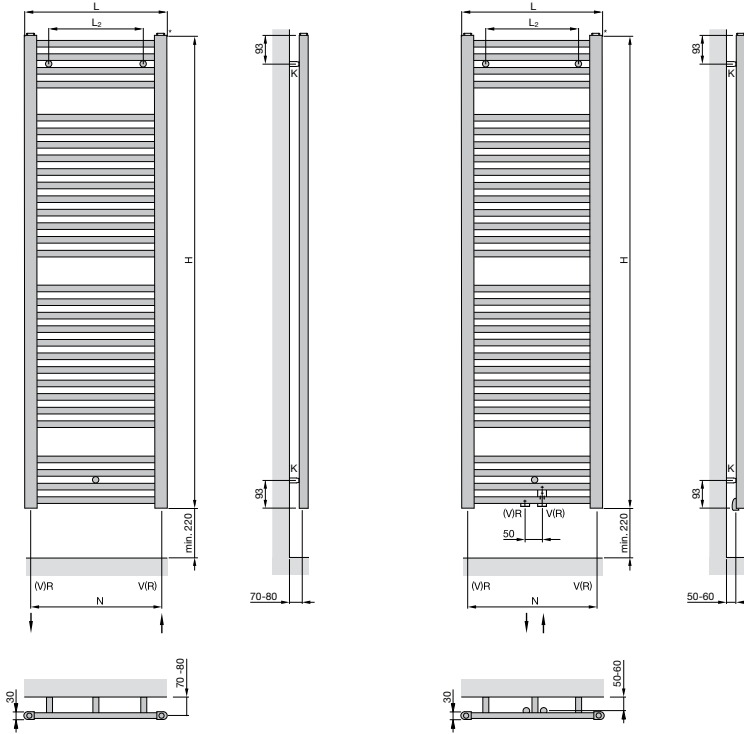

- H = Height
- L = Length
- K = Bracket
- V = Flow 1/2"
- R = Return 1/2"
- N = Boss spacing, L - 44 mm
- L<sub>2</sub> = Length - 150 mm

Dimensions in mm

# Zehnder Virando Bow



Radiator surface: *Ruby Red*

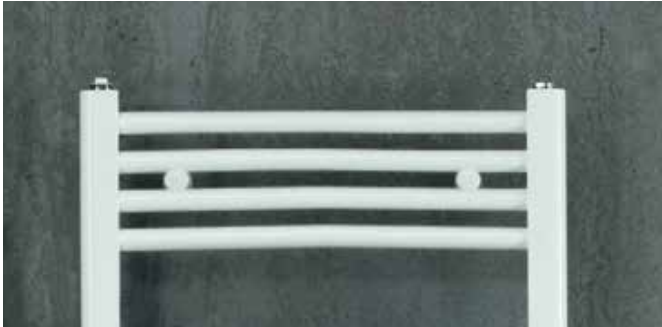

### Hot water operation

Clarity and class. Zehnder Virando Bow has what any lover of modern style looks for. A clear design, with horizontal and straight tube elements allows for ample space for hanging towels.

Zehnder Virando Bow designer radiator made from horizontally arranged precision curved steel tubes with vertical D-profile tubes. Round tubes Ø 23 mm, D-tubes 30 x 40 mm. Available in almost any colour and finish from the Zehnder colour chart. Delivered ready to install with matching wall brackets, packaging.

Maximum operating pressure	max. 12 bar
Operating temperature	max. 120 °C
Height	..... mm
Length	..... mm
Model	.....

### Benefits

- Timeless design creates an aesthetic accent
- Generous spaces between the tubes convenient for hanging towels
- Top-grade chrome finish
- Ample spaces between tubes make cleaning easy
- Flexible installation due to 50 mm centre connections

# Zehnder Virando Bow

## Overview of models

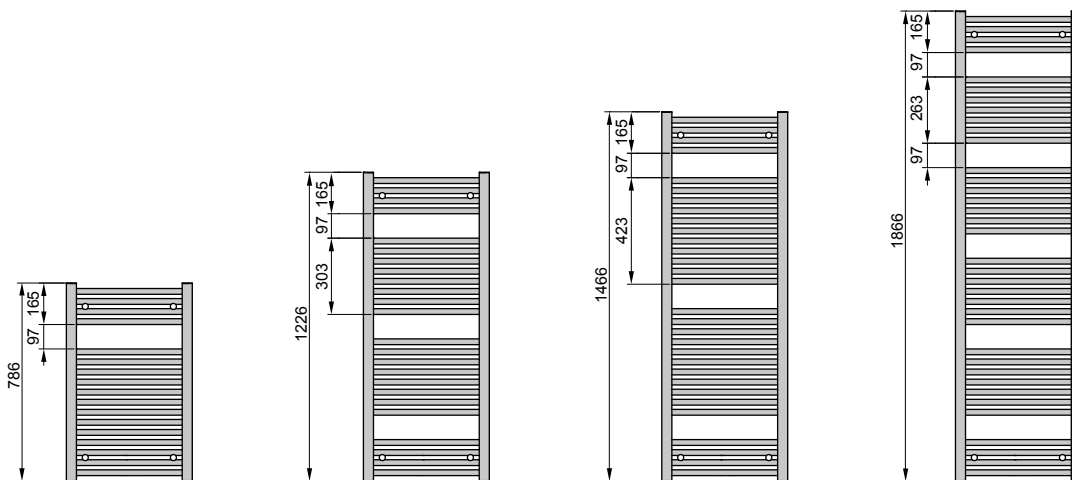

### Connection to hot water central heating system or for dual energy operation

Model	H mm	L mm	Thermal output			Exp. n	Classification Electric heating element Watt	V dm <sup>3</sup>	M kg	Price RAL 9016 €	Price Cat. 1 €	Price Cat. 2 €
			EN 442 <sup>Ⓢ</sup> W	70/55/24 W	55/45/24 W							

Painted version, connection from bottom													
ABT-080-050	786	494	398	283	173	208	1,26	300	4,0	6,2	142,03	177,53	250,91
ABT-120-050	1226	494	567	405	248	298	1,25	300	5,9	9,0	198,96	248,70	322,08
ABT-150-050	1466	494	689	491	301	361	1,25	600	7,1	11,1	217,10	271,37	344,75
ABT-180-050	1866	494	828	589	360	433	1,26	600	8,8	13,4	249,71	312,14	385,52
ABT-080-060	786	595	463	331	204	244	1,24	300	4,6	7,1	147,55	184,43	257,81
ABT-120-060	1226	595	658	469	288	345	1,25	600	6,7	10,3	208,15	260,19	333,57
ABT-150-060	1466	595	803	573	351	421	1,25	600	8,1	12,7	227,83	284,78	358,16
ABT-180-060	1866	595	966	687	419	504	1,26	900	10,0	15,4	262,49	328,11	401,49
ABT-120-075	1226	747	799	570	350	419	1,25	600	8,0	12,2	209,82	262,28	335,66
ABT-150-075	1466	747	978	698	428	514	1,25	900	9,7	15,2	247,14	308,93	382,31
ABT-180-075	1866	747	1178	836	509	612	1,27	900	11,8	18,4	288,56	360,70	434,08

Model	H mm	L mm	Thermal output			Exp. n	Classification Electric heating element Watt	V dm <sup>3</sup>	M kg	Price RAL 9016 €	Price Cat. 1 €	Price Cat. 2 €
			EN 442 <sup>Ⓢ</sup> W	70/55/24 W	55/45/24 W							

Painted version, connection central 50 mm													
ABT-080-050-05	786	494	398	283	173	208	1,24	300	4,0	6,5	157,19	196,49	269,87
ABT-120-050-05	1226	494	567	405	248	298	1,25	300	5,9	9,3	214,12	267,65	341,03
ABT-150-050-05	1466	494	689	491	301	361	1,25	600	7,1	11,4	232,22	290,28	363,66
ABT-180-050-05	1866	494	828	589	360	433	1,26	600	8,8	13,7	264,86	331,08	404,46
ABT-080-060-05	786	595	463	331	204	244	1,24	300	4,6	7,4	162,67	203,34	276,72
ABT-120-060-05	1226	595	658	469	288	345	1,25	600	6,7	10,6	223,30	279,13	352,51
ABT-150-060-05	1466	595	803	573	351	421	1,25	600	8,1	13,0	243,02	303,78	377,16
ABT-180-060-05	1866	595	966	687	419	504	1,26	900	10,0	15,7	277,63	347,04	420,42
ABT-120-075-05	1226	747	799	570	350	419	1,25	600	8,0	12,5	227,78	284,73	358,11
ABT-150-075-05	1466	747	978	698	428	514	1,25	900	9,7	15,5	265,06	331,33	404,71
ABT-180-075-05	1866	747	1178	836	509	612	1,27	900	11,8	18,7	306,52	383,15	456,53

Ⓢ Thermal output measured according to EN 442, ΔT 50 K (75/65/20 °C)

## Zehnder Virando Bow

### Connection to hot water central heating system or for dual energy operation

Model	H mm	L mm	Thermal output			Exp. n	Classification Electric heating element Watt	V dm <sup>3</sup>	M kg	Price Chrome €
			EN 442 <sup>Ⓞ</sup> W	70/55/24 W	55/45/24 W					

#### Chrome-plated version, connection from below

<b>ABTC-080-050</b>	786	494	276	196	119	144	1,26	-	4,0	6,2	<b>414,68</b>
<b>ABTC-120-050</b>	1226	494	411	291	177	213	1,27	300	5,9	9,0	<b>555,96</b>
<b>ABTC-150-050</b>	1466	494	485	346	212	254	1,25	300	7,1	11,1	<b>669,44</b>
<b>ABTC-180-050</b>	1866	494	611	435	265	319	1,26	600	8,8	13,4	<b>785,20</b>
<b>ABTC-080-060</b>	786	595	326	231	141	170	1,26	300	4,6	7,1	<b>466,08</b>
<b>ABTC-120-060</b>	1226	595	484	344	209	252	1,26	300	6,7	10,3	<b>629,74</b>
<b>ABTC-150-060</b>	1466	595	572	407	249	299	1,25	300	8,1	12,7	<b>763,20</b>
<b>ABTC-180-060</b>	1866	595	720	512	313	376	1,26	600	10,0	15,4	<b>904,34</b>

Model	H mm	L mm	Thermal output			Exp. n	Classification Electric heating element Watt	V dm <sup>3</sup>	M kg	Price Chrome €
			EN 442 <sup>Ⓞ</sup> W	70/55/24 W	55/45/24 W					

#### Chrome-plated version, connection central 50 mm

<b>ABTC-080-050-05</b>	786	494	276	196	119	144	1,26	-	4,0	6,5	<b>446,26</b>
<b>ABTC-120-050-05</b>	1226	494	411	292	178	214	1,26	300	5,9	9,3	<b>587,44</b>
<b>ABTC-150-050-05</b>	1466	494	485	346	212	254	1,25	300	7,1	11,4	<b>700,94</b>
<b>ABTC-180-050-05</b>	1866	494	611	435	265	319	1,26	600	8,8	13,7	<b>824,30</b>
<b>ABTC-080-060-05</b>	786	595	326	231	141	170	1,26	300	4,6	7,4	<b>497,58</b>
<b>ABTC-120-060-05</b>	1226	595	484	344	209	252	1,26	300	6,7	10,6	<b>661,36</b>
<b>ABTC-150-060-05</b>	1466	595	572	407	249	299	1,25	300	8,1	13,0	<b>794,68</b>
<b>ABTC-180-060-05</b>	1866	595	720	513	314	377	1,25	600	10,0	15,7	<b>936,00</b>

### Standard scope of delivery for hot water operation

- Powder coating to DIN 55900, RAL 9016
- 4 x ½" connections for flow, return, air vent and plug
- 1 air vent ½" and 1 blind plug ½"
- Mounting accessories in colour of radiator
- Packaging

Ⓞ Thermal output measured according to EN 442, ΔT 50 K (75/65/20 °C)

# Zehnder Virando Bow

**Hot water operation:**  
Wall mounting

Wall mounting  
centre connections 50 mm

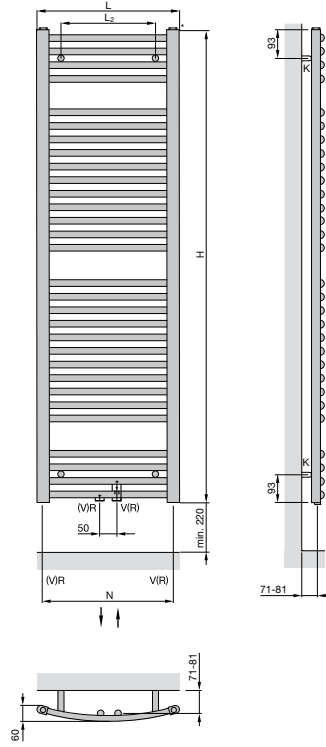
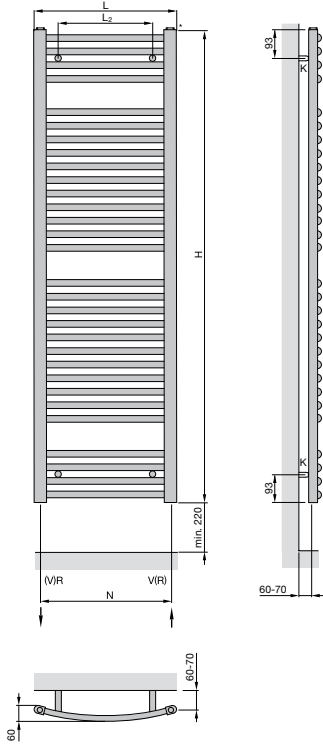

- H = Height
- L = Length
- K = Bracket
- V = Flow 1/2"
- R = Return 1/2"
- N = Boss spacing, L - 44 mm
- L<sub>2</sub> = Length - 150 mm

Dimensions in mm

# Zehnder Aura



Radiator colour: Traffic White

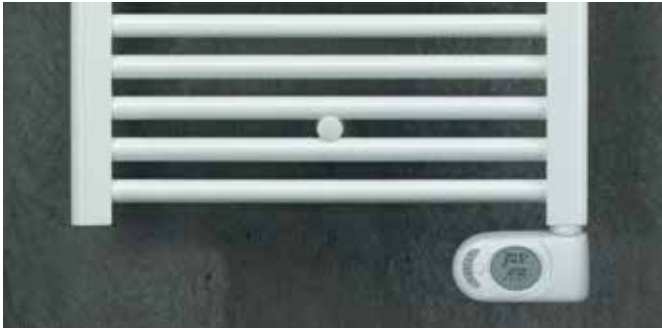

Radiator for electric operation with Musa Eco

### Operation on hot water central heating system

Zehnder Aura decorative radiator made from horizontally arranged precision steel tubes with vertical D-profile tubes. Round tube Ø 22 mm, D-tube 30 x 40 mm. Thermal output tested to EN 422, with CE marking. 4 x 1/2" for flow/return in the manifold tube with air vent 1/4". Alternatively with centre connections 1/2", distance 50 mm, flow and return freely selectable. Delivered ready to install with matching wall brackets. Radiator with powder coating, in colour RAL 9016 as standard and in chrome, with packaging.

Maximum operating pressure	max. 10.0 bar
Operating temperature	max. 90 °C
Height	..... mm
Length	..... mm
Model	.....

### Benefits

- Harmonious design through D-profile of vertical tubes
- Large cut-outs
- Top-grade chrome finish
- Easy to clean
- Entry-level model for all types of tender businesses
- Dual energy operation possible with T-piece

### Standard scope of delivery

- Powder coating to DIN55900, RAL 9016
- 2 x 1/2" connections for flow, return or
- 4 x 1/2" connections for flow, return, electric heating element
- 1 x blind plug 1/2" or
- 3 x blind plug 1/2" with middle connection
- 1 x air vent 1/2"
- Accessories in colour of radiator
- Packaging

### Electric operation

Zehnder Aura decorative radiator made from horizontally arranged precision steel tubes with vertical D-profile tubes. Round tube Ø 22 mm, D-tube 30 x 40 mm. With built-in electric heating element Musa Eco. Protection class IP 44 (splash-proof), for mains power supply of 230 V. Connection cable (1,3 m) with Euro plug. Installation at bottom right. Decorative radiator filled with heat transfer fluid. Delivered ready to install with elegant wall brackets. Standard version with powder coating, in colour RAL 9016, in special colour on request.

### Benefits

- High energy efficiency due to compliance with the European Ecodesign Directive reduces energy costs
- User-friendly control device allows simple operation
- Customisable daily and weekly programmes for convenient, on-demand operation
- Increased safety with keylock

### Standard scope of delivery

- Powder coating to DIN 55900, RAL 9016
- Filled with heat transfer liquid
- With integrated electric heating element MUSA Eco with seven operational modes: comfort, night, anti-freeze, fil-pilot, chrono, timer- 2h, stand-by, right-mounted
- Mounting accessories in colour of radiator
- Packaging

# Zehnder Aura

## Overview of models

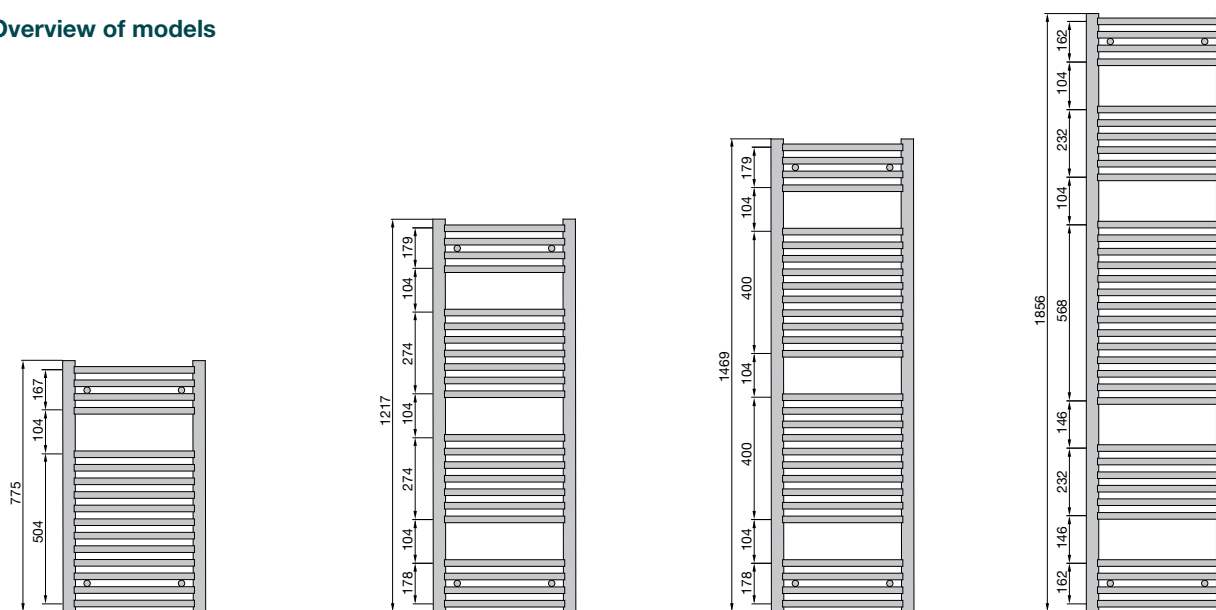

## Connection to hot water central heating system or for dual energy operation

Model	H mm	L mm	EN 442 <sup>③</sup> W	Thermal output			Exp. n	Classification Electric heating element Watt	V dm <sup>3</sup>	M kg	Price RAL 9016 €
				70/55/24 W	55/45/24 W	55/45/20 W					

### Painted version, connection from bottom

PBN-080-045	775	450	327	234	146	176	1,20	300	3,4	5,3	106,04
PBN-120-045	1217	450	468	335	207	248	1,23	300	4,8	7,7	152,54
PBN-150-045	1469	450	575	410	253	303	1,24	300	6,0	9,6	168,05
PBN-180-045	1856	450	719	511	314	379	1,24	600	7,4	12,0	192,29
PBN-080-050	775	500	358	257	161	193	1,20	300	3,6	5,8	109,14
PBN-120-050	1217	500	512	365	225	271	1,23	300	5,2	8,3	157,21
PBN-150-050	1469	500	631	449	276	332	1,24	600	6,5	10,4	172,49
PBN-180-050	1856	500	788	560	344	415	1,24	600	8,0	12,8	200,08
PBN-080-060	775	600	418	303	190	226	1,19	300	4,1	6,6	113,80
PBN-120-060	1217	600	598	424	262	317	1,23	600	5,9	9,6	164,95
PBN-150-060	1469	600	740	525	324	392	1,23	600	7,4	11,9	181,61
PBN-180-060	1856	600	925	656	404	487	1,24	900	9,1	14,6	210,82

Model	H mm	L mm	EN 442 <sup>③</sup> W	Thermal output			Exp. n	Classification Electric heating element Watt	V dm <sup>3</sup>	M kg	Price RAL 9016 €
				70/55/24 W	55/45/24 W	55/45/20 W					

### Painted version, connection central 50 mm

PBN-080-045-05	775	450	327	234	146	176	1,20	300	3,4	5,3	122,40
PBN-120-045-05	1217	450	468	335	207	248	1,23	300	4,8	7,7	170,31
PBN-150-045-05	1469	450	575	410	253	303	1,24	300	6,0	9,6	186,28
PBN-180-045-05	1856	450	719	511	314	379	1,24	600	7,4	12,0	211,27
PBN-080-050-05	775	500	358	257	161	193	1,20	300	3,6	5,8	125,60
PBN-120-050-05	1217	500	512	365	225	271	1,23	300	5,2	8,3	175,11
PBN-150-050-05	1469	500	631	449	276	332	1,24	600	6,5	10,4	190,84
PBN-180-050-05	1856	500	788	560	344	415	1,24	600	8,0	12,8	219,24
PBN-080-060-05	775	600	418	303	190	226	1,19	300	4,1	6,6	130,38
PBN-120-060-05	1217	600	598	424	262	317	1,23	600	5,9	9,6	183,06
PBN-150-060-05	1469	600	740	525	324	392	1,23	600	7,4	11,9	200,19
PBN-180-060-05	1856	600	925	656	404	487	1,24	900	9,1	14,6	230,31

③ Thermal output measured according to EN 442, ΔT 50 K (75/65/20 °C)

## Zehnder Aura

### Connection to hot water central heating system or for dual energy operation

Model	H mm	L mm	Thermal output			Exp. n	Classification Electric heating element Watt	V dm <sup>3</sup>	M kg	Price Chrome €	
			EN 442 <sup>Ⓢ</sup> W	70/55/24 W	55/45/24 W						55/45/20 W
<b>Painted version black matt, connection from bottom</b>											
PBN-080-045-9205	775	450	327	234	146	176	1,20	-	3,40	5,30	<b>132,55</b>
PBN-120-045-9205	1217	450	468	335	207	248	1,23	-	4,80	7,70	<b>190,68</b>
PBN-150-045-9205	1469	450	575	410	253	303	1,24	-	6,00	9,60	<b>210,07</b>
PBN-180-045-9205	1856	450	719	511	314	379	1,24	-	7,40	12,00	<b>240,37</b>
PBN-080-050-9205	775	500	358	257	161	193	1,20	-	3,60	5,80	<b>136,42</b>
PBN-120-050-9205	1217	500	512	365	225	271	1,23	-	5,20	8,30	<b>196,51</b>
PBN-150-050-9205	1469	500	631	449	276	332	1,24	-	6,50	10,40	<b>215,61</b>
PBN-180-050-9205	1856	500	788	560	344	415	1,24	-	8,00	12,80	<b>250,10</b>
PBN-080-060-9205	775	600	418	303	190	226	1,19	-	4,10	6,60	<b>142,25</b>
PBN-120-060-9205	1217	600	598	424	262	317	1,23	-	5,90	9,60	<b>206,18</b>
PBN-150-060-9205	1469	600	740	525	324	392	1,23	-	7,40	11,90	<b>227,01</b>
PBN-180-060-9205	1856	600	925	656	404	487	1,24	-	9,10	14,60	<b>263,53</b>

### Connection to hot water central heating system or for dual energy operation

Model	H mm	L mm	Thermal output			Exp. n	Classification Electric heating element Watt	V dm <sup>3</sup>	M kg	Price Chrome €	
			EN 442 <sup>Ⓢ</sup> W	70/55/24 W	55/45/24 W						55/45/20 W
<b>Chrome-plated version, connection from bottom</b>											
PBCN-080-045	775	450	206	145	87	105	1,30	-	3,4	5,5	<b>208,26</b>
PBCN-120-045	1217	450	303	213	128	155	1,30	300	4,8	8,0	<b>283,68</b>
PBCN-150-045	1469	450	368	259	155	188	1,30	300	6,0	9,8	<b>332,14</b>
PBCN-180-045	1856	450	468	329	198	239	1,30	300	7,4	12,2	<b>389,17</b>
PBCN-080-050	775	500	230	161	98	119	1,28	-	3,6	5,9	<b>214,70</b>
PBCN-120-050	1217	500	330	232	140	169	1,29	300	5,2	8,5	<b>292,45</b>
PBCN-150-050	1469	500	407	284	171	209	1,29	300	6,5	10,5	<b>342,42</b>
PBCN-180-050	1856	500	513	360	217	262	1,30	300	8,0	13,0	<b>401,21</b>
PBCN-080-060	775	600	271	195	119	142	1,25	-	4,1	6,7	<b>220,72</b>
PBCN-120-060	1217	600	390	273	165	201	1,28	300	5,9	9,6	<b>301,49</b>
PBCN-150-060	1469	600	481	338	204	248	1,28	300	7,4	11,9	<b>355,75</b>
PBCN-180-060	1856	600	607	425	257	312	1,29	600	9,1	14,7	<b>424,67</b>

Model	H mm	L mm	Thermal output			Exp. n	Classification Electric heating element Watt	V dm <sup>3</sup>	M kg	Price Chrome €	
			EN 442 <sup>Ⓢ</sup> W	70/55/24 W	55/45/24 W						55/45/20 W
<b>Chrome-plated version, connection central 50 mm</b>											
PBCN-120-045-05	1217	450	303	213	128	155	1,30	300	4,8	8,0	<b>306,74</b>
PBCN-150-045-05	1469	450	368	259	155	188	1,30	300	6,0	9,8	<b>356,92</b>
PBCN-180-045-05	1856	450	468	329	198	239	1,30	300	7,4	12,2	<b>416,00</b>
PBCN-080-050-05	775	500	230	161	98	119	1,28	-	3,6	5,9	<b>234,33</b>
PBCN-120-050-05	1217	500	330	232	140	169	1,29	300	5,2	8,5	<b>314,42</b>
PBCN-150-050-05	1469	500	407	284	171	209	1,29	300	6,5	10,5	<b>365,85</b>
PBCN-180-050-05	1856	500	513	360	217	262	1,30	300	8,0	13,0	<b>426,40</b>
PBCN-120-060-05	1217	600	390	273	165	201	1,28	300	5,9	9,6	<b>323,70</b>
PBCN-150-060-05	1469	600	481	338	204	248	1,28	300	7,4	11,9	<b>379,62</b>
PBCN-180-060-05	1856	600	607	425	257	312	1,29	600	9,1	14,7	<b>450,61</b>

Ⓢ Thermal output measured according to EN 442, ΔT 50 K (75/65/20 °C)

## Zehnder Aura

### Electric-only operation

Model	H <sup>⊙</sup> mm	L mm	Classification Electric heating element Watt	Price RAL 9016 €
-------	----------------------	---------	---	------------------------

#### Painted version

PBEZ-080-40/MQ	786	400	300	252,06
PBEZ-090-50/MQ	906	500	500	276,51
PBEZ-120-50/MQ	1226	500	750	319,20
PBEZ-180-50/MQ	1866	500	1000	398,25
PBEZ-120-60/MQ	1226	600	750	333,44
PBEZ-150-60/MQ	1466	600	1000	364,70
PBEZ-180-60/MQ	1866	600	1000	419,39



Model	H <sup>⊙</sup> mm	L mm	Classification Electric heating element Watt	Price Chrome €
-------	----------------------	---------	---	----------------------

#### Chrome-plated version

PBECZ-080-40/MQ	786	400	150	294,65
PBECZ-090-50/MQ	906	500	200	324,66
PBECZ-120-50/MQ	1226	500	300	378,70
PBECZ-180-50/MQ	1866	500	500	478,10
PBECZ-120-60/MQ	1226	600	400	397,07
PBECZ-150-60/MQ	1466	600	400	432,05
PBECZ-180-60/MQ	1866	600	600	505,20

Model	H <sup>⊙</sup> mm	H + Musa Eco mm	L mm	Classification Electric heating element Watt	Price (gross) €
-------	----------------------	-----------------------	---------	---	-----------------------

#### Black matt version

PBEBZ-080-40/MQ	786	860	400	300	272,21
PBEBZ-090-50/MQ	906	980	500	500	298,64
PBEBZ-120-50/MQ	1226	1300	500	750	347,91
PBEBZ-150-60/MQ	1466	1540	600	1000	397,50

Special solution on request (surcharge)	Article number	Price €
▪ Electric heating element for dual energy operation	-	See p. 152 onwards
▪ Zehnder valves, lockshield valves and connection fittings	-	See p. 159 onwards
▪ Zehnder thermostat LH2, M 30 x 1,5, white	819140	35,02
▪ Zehnder thermostat LH2, M 30 x 1,5, chrome	819148	60,35

⊙ Thermal output measured according to EN 442, ΔT 50 K (75/65/20 °C)

For legend, see "Electric operation and Ecodesign Directive" on page 166



## Zehnder Aura Bow



Radiator surface: Chrome

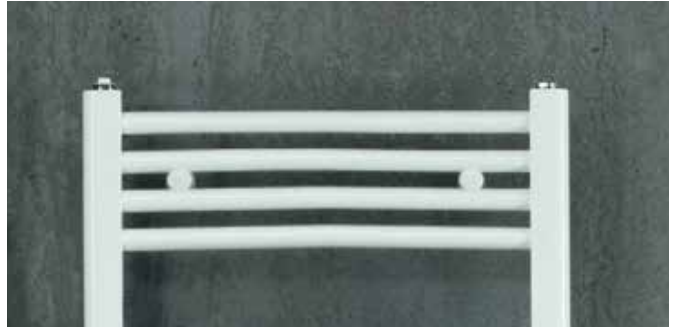

### Operation on hot water central heating system

Zehnder Aura Bow decorative radiator made from horizontally arranged precision steel curved tubes with vertical D-profile tubes. Round tube Ø 22 mm, D-tube 30 x 40 mm. Thermal output tested to EN 422, with CE marking. 4 x 1/2" for flow/return in the manifold tube with air vent 1/4". Alternatively with centre connections 1/2", distance 50 mm, flow and return freely selectable. Delivered ready to install with matching wall brackets. Radiator with powder coating, in colour RAL 9016 as standard and in chrome, with packaging.

Maximum operating pressure	max. 10.0 bar
Operating temperature	max. 90 °C
Height	..... mm
Length	..... mm
Model	.....

### Benefits

- Harmonious design
- Large cut-outs
- Top-grade chrome finish
- Easy to clean
- Entry-level model for all types of tender businesses
- Attractive curvature

### Standard scope of delivery

- Powder coating to DIN 55900, RAL 9016
- 2 x 1/2" connections for flow, return or
- 4 x 1/2" connections for flow, return, electric heating element
- 1 x blind plug 1/2" or
- 3 x blind plug 1/2" with middle connection
- 1 x air vent 1/2"
- Accessories in colour of radiator
- Packaging

## Zehnder Aura Bow

### Overview of models

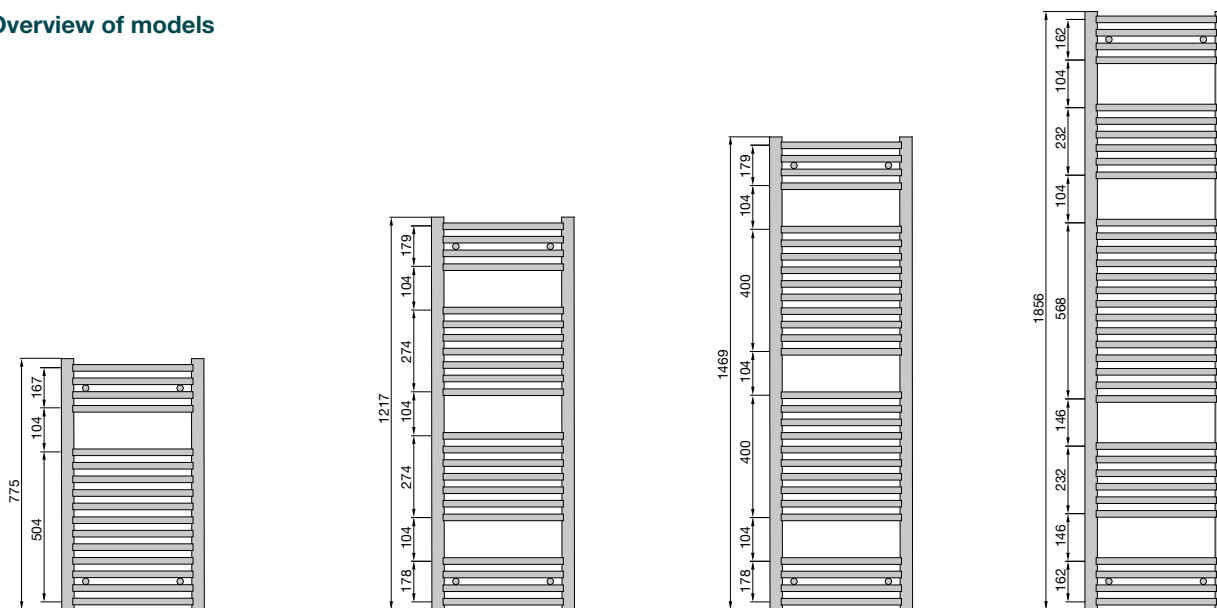

### Connection to hot water central heating system or for dual energy operation

Model	H mm	L mm	Thermal output			Exp. n	Classification Electric heating element Watt	V dm <sup>3</sup>	M kg	Price RAL 9016 €
			EN 442 <sup>Ⓢ</sup> W	70/55/24 W	55/45/24 W					

#### Painted version, connection from bottom

<b>PBTN-080-050</b>	775	494	358	257	161	193	1,20	300	3,6	5,8	<b>123,50</b>
<b>PBTN-120-050</b>	1217	494	512	365	225	271	1,23	300	5,2	8,3	<b>173,01</b>
<b>PBTN-150-050</b>	1469	494	631	450	276	332	1,24	600	6,5	10,4	<b>188,78</b>
<b>PBTN-180-050</b>	1856	494	788	560	344	415	1,24	600	8,0	12,8	<b>217,14</b>
<b>PBTN-120-060</b>	1217	595	598	424	262	317	1,23	600	5,9	9,6	<b>181,00</b>
<b>PBTN-150-060</b>	1469	595	740	525	324	392	1,23	600	7,4	11,9	<b>198,11</b>
<b>PBTN-180-060</b>	1856	595	925	656	404	487	1,24	900	9,1	14,6	<b>228,25</b>

Model	H mm	L mm	Thermal output			Exp. n	Classification Electric heating element Watt	V dm <sup>3</sup>	M kg	Price RAL 9016 €
			EN 442 <sup>Ⓢ</sup> W	70/55/24 W	55/45/24 W					

#### Painted version, connection central 50 mm

<b>PBTN-080-050-05</b>	775	494	358	257	161	193	1,20	300	3,6	5,8	<b>136,69</b>
<b>PBTN-120-050-05</b>	1217	494	512	365	225	271	1,23	300	5,2	8,3	<b>186,19</b>
<b>PBTN-150-050-05</b>	1469	494	631	450	276	332	1,24	600	6,5	10,4	<b>201,93</b>
<b>PBTN-180-050-05</b>	1856	494	788	560	344	415	1,24	600	8,0	12,8	<b>230,31</b>
<b>PBTN-080-060-05</b>	775	595	418	303	190	226	1,19	300	4,1	6,6	<b>141,45</b>
<b>PBTN-120-060-05</b>	1217	595	598	424	262	317	1,23	600	5,9	9,6	<b>194,17</b>
<b>PBTN-150-060-05</b>	1469	595	740	525	324	392	1,23	600	7,4	11,9	<b>211,32</b>
<b>PBTN-180-060-05</b>	1856	595	925	656	404	487	1,24	900	9,1	14,6	<b>241,42</b>

Ⓢ Thermal output measured according to EN 442, ΔT 50 K (75/65/20 °C)

## Zehnder Aura Bow

### Connection to hot water central heating system or for dual energy operation

Model	H mm	L mm	EN 442 <sup>③</sup> W	Thermal output			Exp. n	Classification Electric heating element Watt	V dm <sup>3</sup>	M kg	Price Chrome €
				70/55/24 W	55/45/24 W	55/45/20 W					

Chrome-plated version, connection from bottom											
<b>PBTCN-080-050</b>	775	494	230	161	98	119	1,28	-	3,6	5,9	<b>238,88</b>
<b>PBTCN-120-050</b>	1217	494	330	232	140	169	1,29	300	5,2	8,5	<b>309,66</b>
<b>PBTCN-150-050</b>	1469	494	407	284	171	209	1,29	300	6,5	10,5	<b>359,65</b>
<b>PBTCN-180-050</b>	1856	494	513	360	217	262	1,30	300	8,0	13,0	<b>418,41</b>
<b>PBTCN-080-060</b>	775	595	271	195	119	142	1,25	-	4,1	6,7	<b>237,95</b>
<b>PBTCN-120-060</b>	1217	595	390	273	165	201	1,28	300	5,9	9,6	<b>318,72</b>
<b>PBTCN-150-060</b>	1469	595	481	338	204	248	1,28	300	7,4	11,9	<b>372,98</b>
<b>PBTCN-180-060</b>	1856	595	607	425	257	312	1,29	600	9,1	14,7	<b>441,89</b>

Special solution on request (surcharge)	Article number	Price €
▪ Electric heating element for dual energy operation 	-	See p. 152 onwards
▪ Zehnder valves, lockshield valves and connection fittings	-	See p. 159 onwards
▪ Zehnder thermostat LH2, M 30 x 1,5, white	<b>819140</b>	<b>35,02</b>
▪ Zehnder thermostat LH2, M 30 x 1,5, chrome	<b>819148</b>	<b>60,35</b>

③ Thermal output measured according to EN 442, ΔT 50 K (75/65/20 °C)

For legend, see "Electric operation and Ecodesign Directive" on page 166 

# Zehnder Aura Bow

**Operation on hot water central heating system:**  
Wall mounting

Wall mounting  
centre connections 50 mm

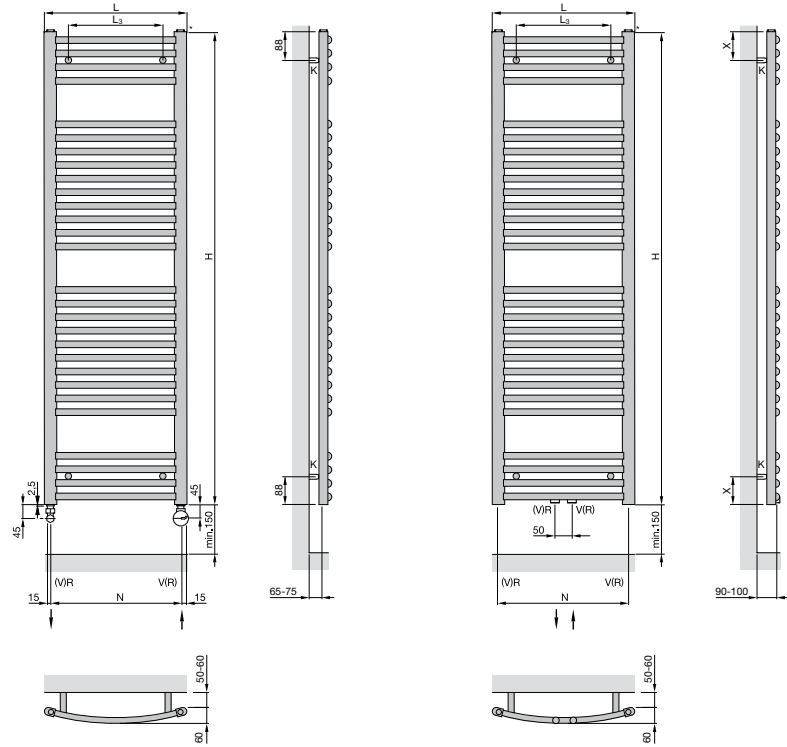

- H = Height
- L = Length
- K = Bracket
- V = Flow 1/2"
- R = Return 1/2"
- N = Boss spacing, L - 50 mm
- T = 60 mm
- L<sub>3</sub> = Length - 150 mm
- X = Fixing point

Dimensions in mm

H (mm)	X (mm)
775	94
1217	105
1469	105
1856	88

**Dual energy operation:**  
with valve block 50 mm angled  
and electric heating element DBM

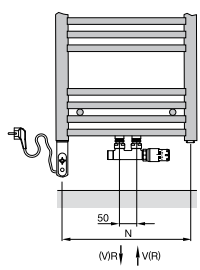

## Zehnder retrofit radiators

- The right model for any retrofitting situation
- Cut-outs and towel rails for hanging and heating towels
- Side connections for easy replacement of old DIN standard radiators
- Convenient operating height of the thermostat due to side connections (accessible)
- Connection options guarantee short installation times for renovations

For more information, see the relevant product sections



*Zehnder Metropolitan Bar*



*Zehnder Toga*

## Zehnder room dividers



*Zehnder Yucca Asym*

For room divider mounting set, see following pages



*Zehnder Toga*





For room divider mounting set, see following pages



*Zehnder Subway*

For room divider version, see Zehnder Subway product pages

## Room divider mounting sets





Description		Version	Article number	Price €	Application
<p><b>Room divider mounting set</b> 2 wall brackets with clamp jaws; cover for wall panel incl. screws and anchors; directional air vents (½"); installation instructions; for wall clearance 80 mm</p>		Standard finish Special finish Chrome-plated	936011 936019 936018	221,50 267,35 292,33	Zehnder Yucca Asym
<p><b>Room divider mounting set without foot support</b> 2 wall brackets comprising wall sleeve (38 mm); sliding part; clamp for D-profile; directional air vent (¼"); fixings; installation instructions; for wall clearance 53 mm</p>		Standard finish Special finish Chrome-plated	931111 931119 931118	131,21 159,53 152,50	Zehnder Toga
<p><b>Room divider mounting set with foot support</b> 2 wall brackets comprising wall sleeve (38 mm); sliding part; clamp for D-profile; floor sleeve (60 mm); spacer (M 10 x 125); fixings; installation instructions; for wall clearance 53 mm</p>		Standard finish Special finish Chrome-plated	931141 931149 931148	159,53 187,93 180,86	Zehnder Toga electric operation
<p><b>Room divider mounting set, long, without foot support</b> 2 wall brackets comprising wall sleeve (88 mm); sliding part; clamp for D-profile; directional air vent (¼"); fixings; installation instructions; for wall clearance 103 mm</p>		Standard finish Special finish Chrome-plated	931211 931219 931218	170,58 197,87 189,56	Zehnder Toga
<p><b>Room divider mounting set, long, with foot support</b> 2 wall brackets comprising wall sleeve (88 mm); sliding part; clamp for D-profile; directional air vent ¼"; floor sleeve (60 mm); distance piece; M 10 x 125; fixings; installation instructions; for wall clearance 103 mm</p>		Standard finish Special finish Chrome-plated	931241 931249 931248	198,95 226,21 217,88	Zehnder Toga electric operation

## Room divider mounting sets

### Mounting sets for repeat ordering

Description		Version	Article number	Price €	Application
<p><b>Room divider mounting set with foot support*</b>                      2 wall brackets comprising wall sleeve (38 mm) and clamp; 1 floor sleeve (50 mm); 1 spacer (M 10 x 125 mm); 1 decorative directional air vent (½"); 1 blanking plug (½"), chrome-plated, fixings; installation instructions; for wall clearance 53 mm</p> <p>* Only for post-ordering, as contained in scope of delivery when ordering the Zehnder Subway and Zehnder Quaro as a room divider model. Due to welded-on threaded bolts, the standard version of the radiator is not suitable for room divider installation.</p>		Standard finish Special finish Chrome-plated	931151 931159 931158	<b>159,53</b> <b>187,93</b> <b>180,86</b>	Zehnder Subway, Zehnder Quaro (each available as room divider version)
<p><b>Separate foot support, for room divider installation 150 mm</b>                      for floor clearance 150-170 mm;                      1 floor sleeve (60 mm); 1 spacer (M 10 x 125 mm); 1 blind hole plug (½"xM10); fixings</p>		Standard finish Special finish Chrome-plated	931301 931309 931308	<b>48,28</b> <b>72,39</b> <b>71,13</b>	
<p><b>Mounting set</b>                      4 wall brackets comprising wall sleeves 40 mm with threaded pin M6; 4 plastic plugs 10 x 50 mm;                      4 phillips screws 6 x 60 mm, galvanized;                      2 directional air vents ½", chrome plated;                      2 air vent covers, plastic chrome-plated;                      1 hexagonal-wrench SW 3 mm</p>		Chrome-plated	950380	<b>74,53</b>	Zehnder Alban
<p><b>Mounting set</b>                      3 painted wall brackets with 2 threaded pins M6 each; 3 plastic plugs 8 x 40 mm; 4 hexagonal screws with slot 6 x 50 mm, galvanized; 3 spacers;                      1 directional air vent ¼"; 1 hexagonal wrench SW 3 mm</p>		Standard finish Special finish Chrome-plated	962361 962369 962368	<b>80,14</b> <b>140,24</b> <b>149,07</b>	Zehnder Archibald
<p><b>Mounting set</b>                      4 wall brackets comprising wall sleeves 40 mm with threaded pin M6; 4 plastic plugs 10 x 50 mm;                      4 phillips screws 6 x 60 mm, galvanized;                      2 directional air vents ½", chrome-plated;                      2 air vent covers, plastic chrome-plated;                      1 hexagonal wrench SW 3 mm</p>		Chrome-plated	950390	<b>74,53</b>	Zehnder Chime
<p><b>Mounting set</b>                      4 wall brackets comprising wall sleeves (80 mm) with threaded pin, spacer piece with thread and lock screw 6 x 20 mm, galvanized; 4 plastic plugs 8 x 40 mm; 4 hexagonal screws with slot 6 x 50 mm, galvanized; 4 washers, galvanized;                      1 spacer screw hexagon 10 x 70 mm, galvanized; plastic cap hexagon 10 x 19 mm black; locking nut M10; galvanized; 1 hexagonal wrench SW 2,5 mm</p>		White	950331	<b>122,66</b>	Zehnder Deseo Verso
<p><b>Mounting set</b>                      4 wall brackets comprising wall sleeves (40 mm) with threaded pin M5, spacer piece with thread and lock screw 6 x 20 mm, galvanized; 4 plastic plugs 10 x 50 mm; 4 hexagonal screws with slot 6 x 60 mm, galvanized; 1 hexagonal spacer screw 10 x 40 mm, galvanized; 1 hexagonal plastic cap 10 x 10 mm, black; 1 locking nut M10, galvanized; 1 hexagonal wrench SW 2,5 mm</p>		White Black	950251 950259	<b>122,66</b> <b>122,66</b>	Zehnder Folio Glass

## Mounting sets for repeat ordering

Description		Version	Article number	Price €	Application
<b>Mounting set</b> 4 wall brackets comprising wall sleeve (60 mm) with threaded pin; combination spacer (54 mm) and clamp; 4 plastic anchors 10 x 70 mm; 4 hexagonal screws with slot 6 x 80 mm, galvanised; 4 washers, galvanised; 1 Allen key (SW 2,5 mm); 2 directional air vents ½"; installation instructions		Standard finish Special finish Chrome-plated	935011 935019 935018	<b>113,46</b> <b>183,98</b> <b>254,52</b>	Zehnder Yucca Asym
<b>Mounting set</b> 4 wall brackets comprising wall sleeve (60 mm) with threaded pin; combination distance piece (54 mm) and clamp; 4 plastic anchors 10 x 70 mm; 4 hexagonal screws with slot 6 x 80 mm, galvanised; 4 washers, galvanised; 1 Allen key SW 2,5 mm; installation instructions		Standard finish Special finish Chrome-plated	962891 962899 962898	<b>100,16</b> <b>170,70</b> <b>241,20</b>	Zehnder Yucca electric operation with Immersion heater RACY
<b>Mounting set</b> 4 wall brackets comprising wall sleeve (60 mm) with threaded pin; 4 spacers with thread; 4 plastic anchors (8 x 40 mm); 4 hexagonal screws with slot (6 x 50 mm), galvanised; 4 washers, galvanised; 1 Allen key SW 2,5 mm; 1 decorative directional air vent (½"); installation instructions		Standard finish Special finish	962161 962169	<b>97,63</b> <b>129,06</b>	Zehnder Vitalo Bar, Zehnder Folio Belt / Folio Hybrid
<b>Mounting set</b> 1 wall bracket comprising wall sleeve (60 mm) with threaded pin; 1 spacer with thread; 1 chain with 2 chain fasteners; 5 plastic anchors (8 x 40 mm); 5 hexagonal screws with slot (6 x 50 mm), galvanised; 5 washers, galvanised; 1 Allen key SW 2,5 mm; 1 decorative directional air vent (½"); installation instructions		Standard finish Special finish	962171 962179	<b>97,63</b> <b>129,06</b>	Zehnder Vitalo Bar with EasyFit connection box
<b>Mounting set</b> 4 wall brackets comprising wall sleeve (60 mm) with threaded pin; 4 spacers with thread; 4 plastic anchors (8 x 40 mm); 4 hexagonal screws with slot (6 x 50 mm), galvanised; 4 washers, galvanised; 1 Allen key (SW 2,5 mm); installation instructions		Standard finish Special finish	962181 962189	<b>97,63</b> <b>129,06</b>	Zehnder Vitalo Bar electric operation

## Mounting sets for repeat ordering

Description		Version	Article number	Price €	Application
<p><b>Mounting set</b>                      4 wall brackets comprising wall sleeve (40 mm) with threaded pin, spacer (32 mm);                      4 plastic anchors (8 x 40 mm); 4 hexagonal screws with slot (6 x 50 mm), galvanised; 4 washers, galvanised; 1 Allen key (SW 2,5 mm); 1 decorative directional air vent (½"); 2 blanking plugs (½"), chrome-plated; 1 vent tool; installation instructions</p>		Standard finish Special finish	962071 962079	<b>113,46</b> <b>183,98</b>	Zehnder Metropolitan Spa / Bar (can also be used for dual energy operation)
<p><b>Mounting set</b>                      4 wall brackets comprising wall sleeve (40 mm) with threaded pin, distance piece (32 mm); 4 plastic anchors 8 x 40 mm; 4 hexagonal screws with slot 6 x 50 mm, galvanised; 4 washers, galvanised; 1 Allen key SW 2,5 mm; installation instructions</p>		Standard finish Special finish	962081 962089	<b>100,16</b> <b>170,70</b>	Zehnder Metropolitan Spa / Bar electric operation
<p><b>Mounting set</b>                      2 wall brackets AKPS (with anti-lifting);                      2 wall brackets AKP; 4 sound insulation parts;                      8 plastic plugs 8 x 40 mm, 8 hexagonal screws 6 x 50 mm, galvanised; air vent ½", air vent key, installation instruction</p>		Standard finish Special finish	963121 963129	<b>139,00</b> <b>145,95</b>	Zehnder Fina Lean Bar
<p><b>Mounting set</b>                      2 wall brackets AKPS (with anti-lifting);                      2 wall brackets AKP; 4 sound insulation parts;                      8 plastic plugs 8 x 40 mm, 8 hexagonal screws 6 x 50 mm, galvanised; installation instruction</p>		Standard finish Special finish	963131 963139	<b>139,00</b> <b>145,95</b>	Zehnder Fina Lean Bar electric operation

## Mounting sets for repeat ordering

Description		Version	Article number	Price €	Application
<b>Mounting set</b> 4 wall brackets comprising wall sleeve (60 mm) with threaded pin, spacer (32 mm); 4 plastic anchors 8 x 40 mm; 4 hexagonal screws with slot (6 x 50 mm), galvanised; 4 washers, galvanised; 1 Allen key SW 2,5 mm; 1 directional air vent ½"; 2 blanking plugs ½"; installation instructions		Standard finish Special finish Chrome-plated	923191 923199 923198	<b>116,10</b> <b>188,22</b> <b>265,41</b>	Zehnder Kazeane
<b>Mounting set</b> 4 wall brackets comprising wall sleeve (60 mm) with threaded pin, spacer (32 mm); 4 plastic anchors 8 x 40 mm; 4 hexagonal screws with slot (6 x 50 mm), galvanised; 4 washers, galvanised; 1 Allen key SW 2,5 mm; installation instructions		Standard finish Special finish Chrome-plated	950281 950289 950288	<b>100,16</b> <b>170,70</b> <b>241,20</b>	Zehnder Kazeane electric operation
<b>Mounting set</b> 4 wall brackets comprising wall sleeve (50 mm) with threaded pin; spacer with thread (M12); 4 plastic anchors (8 x 40 mm); 4 hexagonal screws with slot (6 x 40 mm), galvanised; 4 washers, galvanised; installation instructions		Standard finish Special finish	962671 962679	<b>102,05</b> <b>178,25</b>	Zehnder Roda Spa Asym
<b>Mounting set</b> 4 wall sleeves (60 mm); 4 socket screws (4 x 20 mm); 4 plastic anchors (8 x 40 mm); 4 hexagonal screws with slot (6 x 80 mm), galvanised; 4 washers, galvanised; 1 Allen key (SW 3 mm); 1 decorative directional air vent (½"); 2 blanking plugs (½"), chrome-plated; 1 vent tool; installation instructions		Standard finish Special finish Chrome-plated Stainless steel	952201 952209 952208 952200	<b>118,49</b> <b>192,08</b> <b>265,73</b> <b>265,73</b>	Zehnder Quaro
<b>Mounting set</b> 4 wall sleeves (60 mm); 4 socket screws (4 x 20 mm); 4 plastic anchors (8 x 40 mm); 4 hexagonal screws with slot (6 x 80 mm), galvanised; 4 washers, galvanised; 1 Allen key (SW 3 mm); installation instructions		Standard finish Special finish Chrome-plated	952211 952219 952218	<b>104,59</b> <b>178,26</b> <b>251,83</b>	Zehnder Quaro electric operation
<b>Mounting set</b> 4 wall brackets comprising wall sleeve (40 mm) with threaded pin, spacer (32 mm); 4 plastic anchors (8 x 40 mm); 4 hexagonal screws with slot (6 x 50 mm), galvanised; 4 washers, galvanised; 1 Allen key (SW 2,5 mm); 1 decorative directional air vent (½"); 2 blanking plugs (½"), chrome-plated; 1 vent tool; installation instructions		Standard finish Special finish Chrome-plated	952101 952109 952108	<b>113,46</b> <b>183,98</b> <b>254,52</b>	Zehnder Subway
<b>Mounting set</b> 4 wall brackets comprising wall sleeve (40 mm) with threaded pin, distance piece (32 mm); 4 plastic anchors 8 x 40 mm; 4 hexagonal screws with slot 6 x 50 mm, galvanised; 4 washers, galvanised; 1 Allen key SW 2,5 mm; installation instructions		Standard finish Special finish Chrome-plated	954101 954109 954108	<b>100,16</b> <b>170,70</b> <b>241,20</b>	Zehnder Subway electric operation
<b>Mounting set</b> 4 wall brackets* comprising wall sleeve (60 mm) with threaded pin, spacer (32 mm); 4 plastic anchors (8 x 40 mm); 4 hexagonal screws with slot (6 x 50 mm), galvanised; 4 washers, galvanised; 1 Allen key (SW 2,5 mm); 1 decorative directional air vent (½"); 2 blanking plugs (½"), chrome-plated; 1 vent tool; installation instructions		Standard finish Special finish Chrome-plated	952111 952119 952118	<b>113,46</b> <b>183,98</b> <b>254,52</b>	Zehnder Subway (with extended wall clearance)
<b>Mounting set</b> 4 wall brackets* comprising wall sleeve (60 mm) with threaded pin, spacer (32 mm); 4 plastic anchors 8 x 40 mm; 4 hexagonal screws with slot 6 x 50 mm, galvanised; 4 washers, galvanised; 1 Allen key SW 2,5 mm; installation instructions		Standard finish Special finish Chrome-plated	954111 954119 954118	<b>100,16</b> <b>170,70</b> <b>241,20</b>	Zehnder Subway electric operation (with extended wall clearance)

\* for mounting with extended wall clearance

## Mounting sets for repeat ordering

Description		Version	Article number	Price €	Application
<b>Mounting set</b> 3 wall brackets comprising wall sleeve (60 mm) with threaded pin; combination spacer (40 mm) and clamp; 3 plastic anchors (8 x 40 mm); 3 hexagonal screws with slot (6 x 50 mm), galvanised; 3 washers, galvanised; 1 Allen key (SW 2,5 mm); 1 directional air vent (¼"); installation instructions		Standard finish Special finish Chrome-plated	926021 926029 926028	<b>70,83</b> <b>124,33</b> <b>131,71</b>	Zehnder Toga <sup>1)</sup>
<b>Mounting set</b> 3 wall brackets comprising wall sleeve (60 mm) with threaded pin; combination spacer (40 mm) and clamp; 3 plastic anchors (8 x 40 mm); 3 hexagonal screws with slot (6 x 50 mm), galvanised; 3 washers, galvanised; 1 Allen key (SW 2,5 mm); installation instructions		Standard finish Special finish Chrome-plated	925021 925029 925028	<b>70,83</b> <b>124,33</b> <b>131,71</b>	Zehnder Toga electric operation
<b>Mounting set</b> 4 wall brackets comprising wall sleeve (60 mm) with threaded pin; combination spacer (40 mm) and clamp; 4 plastic anchors (8 x 40 mm); 4 hexagonal screws with slot (6 x 50 mm), galvanised; 4 washers, galvanised; 1 Allen key (SW 2,5 mm); 1 directional air vent (½"); installation instructions		Standard finish Special finish	923131 923139	<b>97,99</b> <b>209,62</b>	Zehnder Forma Asym <sup>1)</sup>
<b>Mounting set</b> 4 wall brackets comprising wall sleeve (80 mm) with threaded pin; combination spacer (40 mm) and clamp; 4 plastic anchors (8 x 40 mm); 4 hexagonal screws with slot (6 x 50 mm), galvanised; 4 washers, galvanised; 1 Allen key (SW 2,5 mm); installation instructions		Standard finish Special finish	950291 950299	<b>97,99</b> <b>209,62</b>	Zehnder Forma Asym electric operation
<b>Mounting set</b> 4 wall brackets comprising wall sleeve (60 mm) with threaded pin; combination spacer (40 mm) and clamp; 4 plastic anchors (8 x 40 mm); 4 hexagonal screws with slot (6 x 50 mm), galvanised; 4 washers, galvanised; 1 Allen key (SW 2,5 mm); 1 directional air vent (½"); installation instructions		Standard finish Special finish Chrome-plated Stainless steel	923021 923029 923028 923060	<b>96,18</b> <b>205,75</b> <b>217,98</b> <b>217,98</b>	Zehnder Forma Spa
<b>Mounting set</b> 4 wall brackets comprising wall sleeve (50 mm) with threaded pin; 4 spacers (25 mm) with thread; 4 plastic anchors (8 x 40 mm); 4 hexagonal screws (10 x 45 mm), galvanised; 4 washers, galvanised; directional air vent (½"); blanking plug (½"); installation instructions		Standard finish Special finish	923041 923049	<b>59,11</b> <b>118,22</b>	Zehnder Forma Spa double-layer
<b>Mounting set</b> 4 wall brackets comprising wall sleeve (60 mm) with threaded pin; combination spacer (40 mm) and clamp; 4 plastic anchors (8 x 40 mm); 4 hexagonal screws with slot 6 x 50 mm, galvanised; 4 washers, galvanised; 1 Allen key (SW 2,5 mm); installation instructions		Standard finish Special finish Chrome-plated	923031 923039 923038	<b>96,18</b> <b>205,75</b> <b>217,98</b>	Zehnder Forma Spa electric operation
<b>Mounting set</b> 4 wall brackets comprising wall sleeve (40 mm) with threaded pin, distance piece (32 mm); 4 plastic anchors 8 x 40 mm; 4 hexagonal screws with slot 6 x 50 mm, galvanised; 4 washers, galvanised; 1 Allen key SW 2,5 mm; 1 air vent ½"; 1 blanking plug ½", chrome-plated; 1 venting key	Without illustration	Chrome-plated	928052	<b>248,28</b>	Zehnder Stalox







<sup>1)</sup> In the case of radiators with centre connections, the original scope of delivery includes two additional blanking plugs.

## Mounting sets for repeat ordering

Description	Version	Article number	Price €	Application	
<b>Mounting set</b> 4 wall brackets comprising wall sleeve with fixing screws and cover; 4 distance pieces; 4 plastic anchors; 4 screws 5,5 x 50 mm, 4 washers, 1 air vent ½", 1 blanking plug ½"	Without illustration	White (straight version)	926511	<b>44,49</b>	Zehnder Aura
		White (curved version)	926521	<b>56,96</b>	
		Chrome (straight version)	926518	<b>67,32</b>	
		Chrome (curved version)	926528	<b>83,62</b>	
<b>Mounting set</b> 3 wall brackets comprising wall sleeve with 3 plastic anchors 8 x 40 mm; 3 hexagonal screws 5,5 x 50 mm, galvanised; 3 washers, galvanised; 1 Allen key for M5; 1 blind plug	Without illustration	White	926281	<b>38,13</b>	Zehnder Aura electric
		Chrome	926288	<b>54,58</b>	
		Black matt	926289	<b>45,17</b>	
<b>Extension set for wall brackets</b> consisting of 2 wall sleeves (80 mm) for installation for extended wall clearance; incl. screws and anchors  Application: compensating for a recess in the wall (e.g. tile edge)		Standard finish	782061	<b>41,87</b>	Vitalo Bar, Toga, Forma Asym / Spa (single-layer)
		Special finish	782069	<b>57,37</b>	
		Chrome-plated	782068	<b>60,81</b>	
<b>Mounting set</b> 4 wall brackets with threaded pin; 4 plastic anchors; 4 screws 5,5 x 50 mm, 4 washers; 1 air vent ½", 1 blanking plug ½"; 1 Allen key 2,5 mm	Without illustration	White	926281	<b>38,13</b>	Zehnder Virando
		Chrome-plated	926288	<b>54,58</b>	
		Special finish	926289	<b>45,17</b>	
<b>Mounting set</b> 4 wall brackets with threaded pin; 4 plastic anchors; 4 screws 5,5 x 50 mm, 4 washers; 1 air vent ½", 1 blanking plug ½"; 1 Allen key 2,5 mm	Without illustration	White	926191	<b>42,78</b>	Zehnder Virando Bow
		Special finish	926199	<b>50,83</b>	
<b>Mounting set</b> 4 wall brackets with threaded pin; 4 plastic anchors; 4 screws 5,5 x 50 mm, 4 washers; 1 air vent ½", 1 blanking plug ½"; 1 Allen key 2,5 mm	Without illustration	White	926681	<b>44,49</b>	Zehnder Zeta
		Anthracite	926680	<b>46,59</b>	
		Chrome-plated	926688	<b>67,32</b>	

<sup>1)</sup> In the case of radiators with centre connections, the original scope of delivery includes two additional blanking plugs.

## Comfort accessories

Description		Version	Article number	Price €	Application
<b>Towel rail</b> High-quality towel rail in stainless steel. For subsequent assembly in any height. Rectangular version 30 x 4 mm.		342 [305]	468002	<b>214,06</b>	Arteplano
		490 [453]	468012	<b>228,32</b>	
		638 [601]	468022	<b>242,58</b>	
<b>Towel rail</b> High-quality towel rail in steel, chrome plated. For subsequent assembly in fixed position.		490 [441]	468438	<b>242,58</b>	Folio Glass
		590 [540]	468448	<b>256,85</b>	
<b>Towel rail</b> High-quality towel rail in brass, chrome-plated, with concealed attachment for asymmetric (max. 395 mm) or symmetric installation; max. load 5 kg (asym.) or 10 kg (sym.)		295 [400]	468038	<b>156,06</b>	Metropolitan Spa / Bar
		395 [500]	468048	<b>156,06</b>	
		495 [600]	468058	<b>156,06</b>	
		795 [900]	468078	<b>186,16</b>	
<b>Towel hook</b> Set of 2 high-quality towel hooks in steel, chrome-plated, with soft insert for simple attachment; max. load 5 kg			480438	<b>57,04</b>	Metropolitan Spa / Bar, Kazeane
<b>Towel rail</b> High-quality design in brass, chrome-plated, with 2-point magnetic holder; max. load 5 kg		399 (297)	471108	<b>269,02</b>	Roda Twist Spa Air, Metropolitan Spa / Bar
		432 (330)	471118	<b>280,57</b>	
		531 (429)	471128	<b>308,62</b>	
<b>Towel hook</b> High-quality double hook in brass, chrome-plated, with 1-point magnetic holder; max. load 5 kg		100	470328	<b>135,31</b>	Roda Twist Spa Air, Metropolitan Spa / Bar
<b>Lambswool cleaning brush</b> 3-finger brush with real lambswool trimming for optimum cleaning of the tubes, and all points that are hard to access			601040	<b>60,41</b>	Yucca <sup>2)</sup> , Toga
			601020	<b>55,16</b>	Charleston Bar

<sup>1)</sup> Overall length of the holder at the outermost points; figure in round brackets for fixing dimension for 2-point attachment; figure in square brackets for related radiator length.

<sup>2)</sup> Yucca, Yucca Asym.



# We will make you fit for the future

With our new generation of immersion heaters, Zehnder is setting standards that go far beyond heating. Easy to install and with intuitive controls, these immersion heaters provide the maximum user comfort.

There is also a wide range of control options to suit every need.

Targeted radiator controls are another impressive feature, helping to reduce energy costs while reducing the environmental impact at the same time.

**Comfort and variety to suit every need.**



**Get ready for the future with the new generation of immersion heaters.**

This icon is displayed alongside all of our designer radiators that can be used with our new range of immersion heaters.

## Clear advantages

- Simple and intuitive – with up to three control options
- The perfect solution for a wide range of individual needs
- Modern and elegant design
- Save the planet and money too, through targeted energy use



### State-of-the-art technology

- Adjustable surface temperature
- Temperature controls for each room
- Timer function
- Daily and weekly programming via the app
- Integrated energy efficiency in line with ecodesign requirements

# Easy to use in every way

## The Zehnder Immersion Heater Control (IHC)

The Immersion Heater Control (IHC) is the all-rounder among the new Zehnder immersion heaters. Thanks to its modular operating concept, it suits a wide range of needs and is extremely user friendly.

Choose how to control the radiator: directly using the dial, with a remote control or using the handy Zehnder Connect app.

Every option is intuitive and self-explanatory. The LED matrix display shows the current operating status in a clear and simple way. In addition to its easy, comfortable range of controls, the IHC is also sustainable, as the electronic control unit can be replaced independently from the immersion heater.

#sustainability  
#digital  
#optionsforeveryone

#userfriendly  
#security  
#modularity



LED matrix display

Rotary knob

### 1 Control directly from the immersion heater

Press and rotate the knob to switch between the various heating modes and adjust temperatures and configurations.

**Simple, intuitive control without additional devices**



## 2 Easy remote control

The Easy remote control, which can be ordered separately, is designed to manage basic functions used on a daily basis, such as “On/Off” and “Adjust room temperature”. A wall mount is provided for installation at a convenient height, and the remote control can be taken out of the mount for use. The remote control can also be used without a base mount.

**Comfortable control at a convenient height**

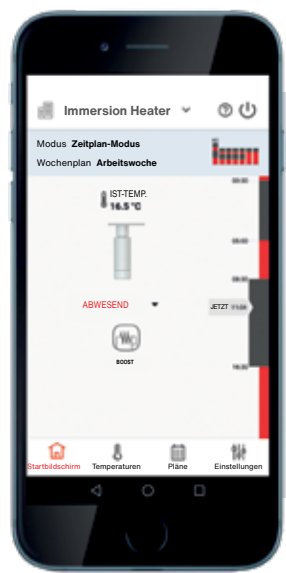

## 3 Zehnder Connect app

Use the Zehnder Connect app to control radiators via a Bluetooth-enabled smartphone, with options to set up additional functions such as a weekly programme.

**Smart controls with precise settings**



**Colour options**  
Available in three different colours (black, white and grey) with a modern design featuring an LED matrix display

# Sustainable and easy to integrate

## The Zehnder Immersion Heater Easy (IHE)

The Immersion Heater Easy (IHE) is an integrated option for smart home systems with on-site control.

The new technical Zehnder patented solution reduces output in the upper temperature range to 50%, limiting temperature fluctuations and saving energy. This also extends the immersion heater's service life, making it more sustainable.

**#sustainability**  
**#longerproductlifecycle**  
**#energyefficiency**  
**#easyintegration**



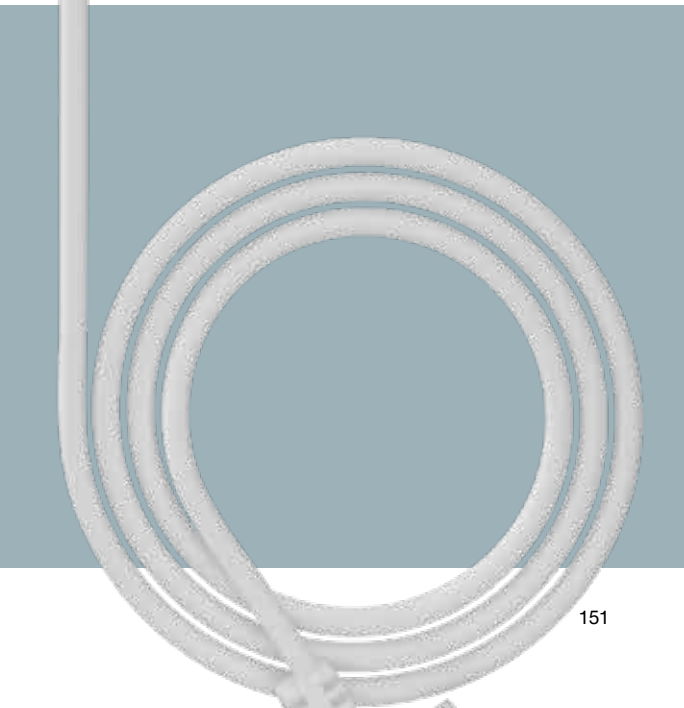

## Electric heating elements for dual energy operation

### Electric heating element IHE 2)

Protection class IP65 (protected against water jets (nozzle) from any angle), protection class I, for mains voltage 230 volts  $\pm 10\%$ . With screw-in thread G 1/2" and 3-core connection cable 1.2 m long with safety plug. With built-in temperature control patented by Zehnder for energy-saving operation and extended service life compared to conventional immersion heaters. The patented temperature control causes the immersion heater to heat up quickly and reduce its power consumption to 50 % when the temperature limit is reached, thus reducing the number of switching cycles and preventing overheating. Thus, power consumption in continuous operation is reduced, safe operation is ensured and a longer service life of the immersion heater is achieved by reducing the number of switching cycles. Temperature limitation of the heat transfer fluid to approx. 70 °C. With dry-running protection (after the temperature limiter has responded and the cause has been eliminated, e.g. insufficient amount of liquid, the immersion heater can be used again after a reset). Housing and cable / plug in white. IHE heating element can be used in dual energy mode without control or in combination with on-site control. Suitable for Zehnder decorative radiators: Yucca, Metropolitan, Kazeane, Quaro, Subway, Toga, Forma, Tetris.

Model	Nominal output Watt	Max. length <sup>3)</sup> in mm	Article number	Price €
IHE White	300	400	858151	<b>83,97</b>
IHE White	600	620	858161	<b>88,67</b>
IHE White	900	850	858171	<b>97,91</b>
IHE White	1200	980	858181	<b>105,00</b>
IHE Chrome	300	420	858158	<b>97,47</b>
IHE Chrome	600	620	858168	<b>102,60</b>
IHE Chrome	900	850	858178	<b>112,86</b>
IHE Chrome	1200	980	858188	<b>123,12</b>

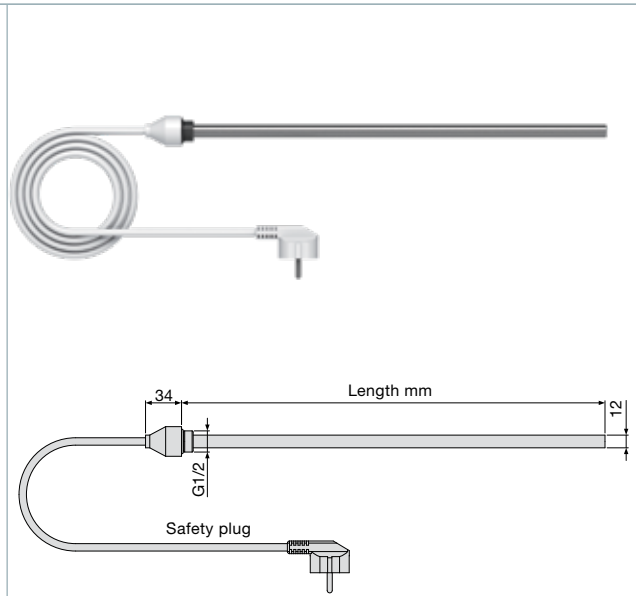

### T-piece

For dual energy operation of hot water central heating system with electric heating element. Installation of T-piece in the return for vertical installation of the electric heating elements IHC or IHE) and connection of the return via an angled return screw connection.

Model	Article number	Price €
T-piece white (WIVAR, RICA, IHE)	853181	<b>27,19</b>
T-piece chrome (WIVAR, RICA, IHE)	853188	<b>28,34</b>
T-piece white (DBM, IHE)	853111	<b>27,19</b>
T-piece chrome (DBM, IHE)	853118	<b>28,34</b>



<sup>2)</sup> Can be used in hot water heating systems with max. operating temperature of 95°C and maximum operating pressure of 4,0 bar  
<sup>3)</sup> Manifold, in which the heat element is build-in needs to have 1,5 times the length of the heating element

## Electric heating elements for dual energy operation

### Immersion heater IHC<sup>1)</sup>

The immersion heater IHC with integrated control has a modular operating concept that is applied according to the user's needs. All basic functions, such as changing the temperature or a timer function, can be set directly on the immersion heater - ideal for customers who do not want an additional device.

For an even simpler and more convenient operation the control unit EASY can additionally be used. With the free Zehnder Connect app (available for the iOS and Android operating systems) and the additionally available Connect box (see page 155), further operating options are available also offering additional setting options. The uniform, intuitive user interface simplifies switching between the three operating options - for even more operating convenience. Great variety of configuration options - the product for every application!

In addition, the immersion heater is available in three housing colours - each with colour-matching cable and plug and is the first immersion heater to offer simple limitation of the surface temperature, which is applied regardless of the mode set. Plastic housing  $\varnothing$  40 mm, length 128 mm. Rated power 300, 600, 900 or 1200 watts. Mains voltage 230 - 240 V, protection class II, protection class IP 54 (splash-proof). With  $\frac{1}{2}$ " thread, 2-core connection cable 1.20 metres, outlet downwards with contour plug in white, grey or black (depending on housing colour). By pressing and turning the rotary knob, the various heating modes can be selected, temperatures adjusted and configuration changes made, for example.

- Room temperature control

(Modes: Frost protection 7 °C, Eco 7-19 °C - preset: 16 °C, Comfort 7-28 °C - preset: 21 °C),  
Eco and comfort temperature can be set separately

- Timer function

(duration can be selected in 5-minute steps from 0 - 95 min and in 1-hour steps from 2 to 4 hours - default: 60 min)

- Further configuration options:

- Hotel mode (reasonable combination with switching via key card or switchable power socket; hotel manager can define which mode is executed when switching on - selectable modes: frost protection, comfort, eco timer, comfort timer, timer).
- Surface temperature limitation

(45, 55, 65 or 80 °C - preset: 80 °C)

- Open window detection

- Daily and weekly programmes adjustable via App Zehnder Connect Suitable or Zehnder decorative radiators:

Yucca, Metropolitan, Kazeane, Quaro, Subway, Toga, Forma, Tetris

Model	Nominal output Watt	Max. length <sup>2)</sup> in mm	Article number	Price €
IHC 300 White	300	350	857981	250,00
IHC 600 White	600	510	857991	260,00
IHC 900 White	900	670	858001	270,00
IHC 1200 White	1200	820	858011	275,00
IHC 300 Grey	300	350	858029	250,00
IHC 600 Grey	600	510	858039	260,00
IHC 900 Grey	900	670	858049	270,00
IHC 1200 Grey	1200	820	858059	275,00
IHC 300 Black	300	350	857989	250,00
IHC 600 Black	600	510	857999	260,00
IHC 900 Black	900	670	858009	270,00
IHC 1200 Black	1200	820	858019	275,00

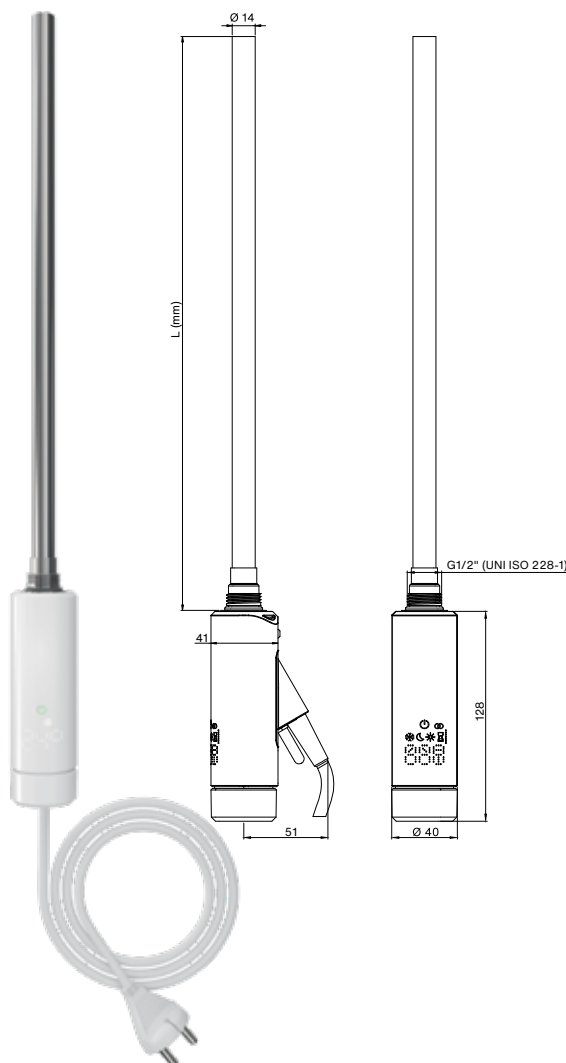

1) Can be used in hot water heating systems with max. operating temperature 95 °C and operating overpressure 4.0 bar

2) The manifolds in which the immersion heater is installed must be max. 1.5 times the length of the immersion heater.

## Electric heating elements for dual energy operation

### Control unit Easy (RCE)

Battery-operated radio control unit for immersion heater IHC - the easy convenient operating option at eye level. With the mode- plus/minus button, the mode can be adapted as well as setpoint temperature and timer. Operating concept analogue to the IHC immersion heater, plastic housing with wall bracket, white.

Can be used either with wall bracket or separately, dimensions of the control unit 130 x 47 x 18 mm. Delivery includes batteries (2 x AA)

Model	Article number	Price €
RCE	887970	133,38



Control unit Easy with Wall mounting frame

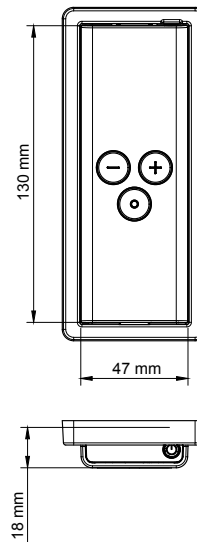

Wall mounting frame

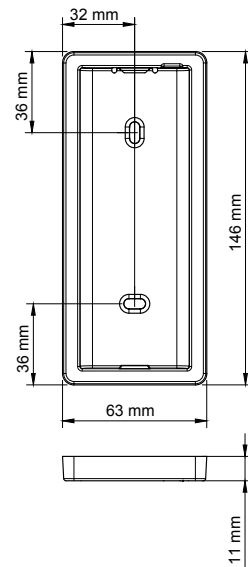

## Electric heating elements for dual energy operation

### Zehnder Connect-Box

For voice control of Zehnder Zenia with the voice assistants Amazon Alexa and Google Assistant. In addition, the Zehnder Connect app in connection with the Zehnder Connect-Box can also be used to remotely control compatible products such as the IHC Immersion heater with a smartphone. Scope of delivery: Zehnder Connect-Box incl. wall bracket, mounting material, LAN cable (length 1.4 m) and connection cable (length 1.9 m) incl. power supply unit with Euro plug for mains voltage 230 V.

Model	Article number	Price €
Zehnder Connect-Box	887220	338,58

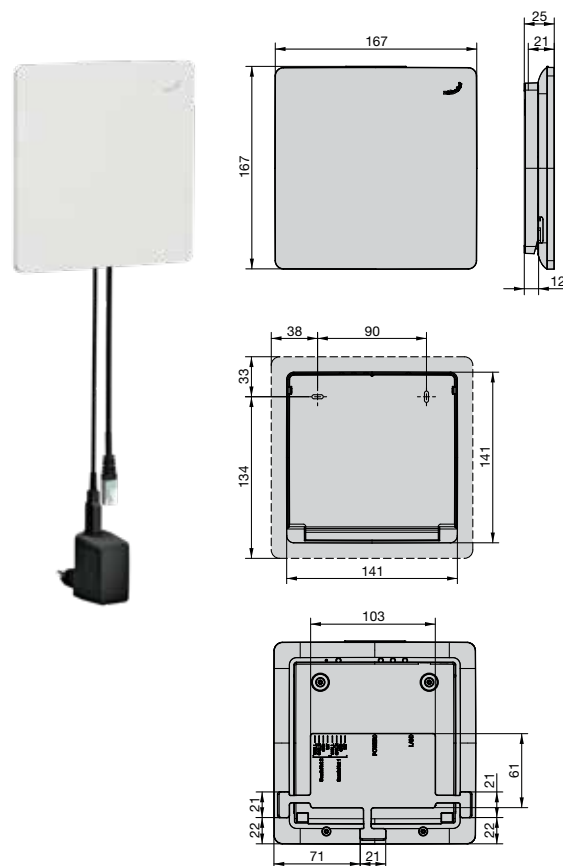

### Timer switch incl. frame

Time setting by means of rotary knob. Timer switch 2 - 120 minutes. Start by pressing the button and premature stop by pressing the button for a longer time. 2-wire connection by means of screw terminals, 8 A / 250 V, mounting in standard flush-mounted box. With cover frame 86 x 86 x 10 mm to snap on. Ideal in combination with immersion heater IHE

Model	Article number	Price €
Timer switch incl. frame / white	856320	119,02
Timer switch incl. frame / Aluminium-optics	856330	121,07

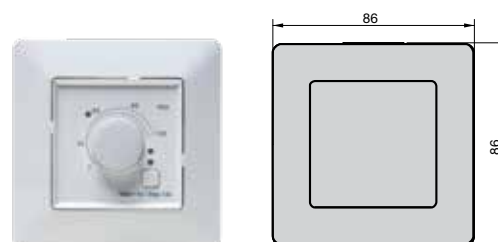

## Electric heating elements for dual energy operation

### Electric heating element DBM 2)

Degree of protection IP44 (splash-proof), for supply voltage 230 V ±10%. With G ½" screw-in thread and 3-core connection cable (1,2 m) with safety plug, collar and assembly key. With dry-running protection against operation without sufficient filling quantity. With rotary knob for selecting the following operating modes:

- Medium temperature max. 40°C
- Medium temperature max. 70°C
- Timer with automatic shut-off after 2 hours
- Off



Model	Nominal output Watt	Max. length in mm	Article number	Price €
DBM 300 white	300	330	857461	405,96
DBM 600 white	600	480	857481	433,24
DBM 900 white	900	630	857501	514,97
DBM 1200 white	1200	800	857521	542,22

Suitable for decorative radiators: Kazeane, Toga, Forma Spa  
(for allocation of output to the radiator models, see product pages)

For legend, see "Electric operation and Ecodesign Directive" on page 166

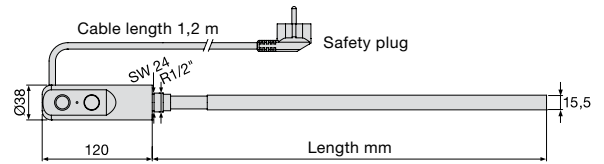

## Electric heating elements for dual energy operation

### Electric heating element WIVAR II <sup>1)</sup>

Standard version for temperature control directly at electric heating element (as towel warmer ) or via optional control device model 1 (as electric radiator ). With control knob to set the medium temperature and LED indicator for the operating mode (see below); white plastic box, Ø 34 mm; 134 mm in length.

Nominal output 300, 600, 900 or 1200 watts. Supply voltage 230–240 V, protection class I (with earth wire), VDE-tested, IP64 degree of protection (splash-proof). With conical ½" screw-in thread incl. assembly key. 3-core connection cable, 1,20 m, downwards outlet with white plug.

#### Operating modes

- Frost protection ~12°C (LED flashes blue every 10 s)
- Heating level 1 ~50°C (green LED)
- Heating level 2 ~65°C (orange LED)
- Timer ~65°C for 2 h (LED flashes orange every 2 s)

Suitable for Zehnder decorative radiators:  
Yucca, Yucca Asym, Subway, Toga, Forma Spa  
(for allocation of output to the radiator models, see product pages)



Model	Nominal output Watt	Length max. mm	Article number	Price €
WIVAR 300	300	305	862522	420,16
WIVAR 600	600	475	862532	439,61
WIVAR 900	900	645	862542	476,99
WIVAR 1200	1200	830	862552	509,89

### Electric heating element WIVAR Hotel

Version same as WIVAR II, but specifically for connection to a switchable socket. Heating level 1 is selected automatically when the system is connected to the mains power supply.



Model	Nominal output Watt	Length max. mm	Article number	Price €
WIVAR Hotel 300	300	305	862400	420,16
WIVAR Hotel 600	600	475	862430	439,61
WIVAR Hotel 900	900	645	862460	476,99
WIVAR Hotel 1200	1200	830	862490	509,89

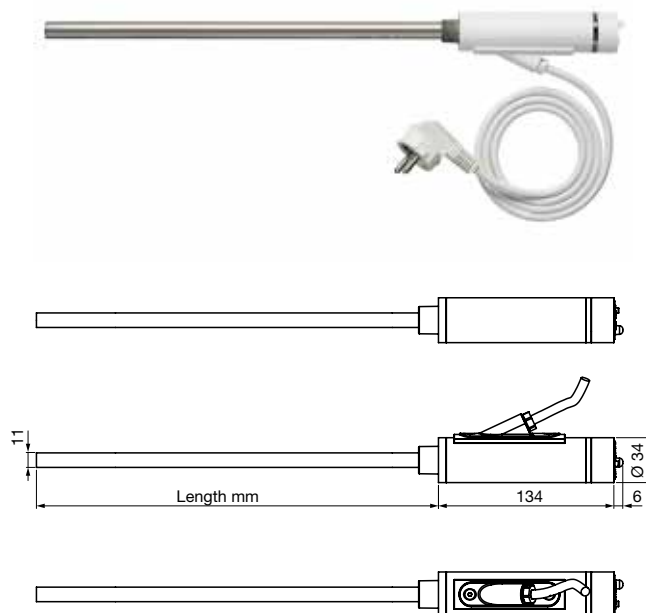

### Cover parts for electric heating element WIVAR II / WIVAR Hotel

For adapting the electric heating element to the radiator colour

Version	Article number	Price €
Cover parts set, chrome-plated	889308	112,17
Cover parts set, in special colour	889309	91,25



### Control device model 1

Battery-operated remote control device (white plastic housing) for room temperature control and for controlling timer functions for WIVAR II; dimensions 88 x 88 x 21 mm.

Model	Article number	Price €
Control device model 1, white	895351	216,83

#### Functions

- Frost protection ~12°C
- Room temperature control with 4 adjustable temperatures
- Timer ~65°C with selectable times: 1/2/4 h
- Battery status indicator
- Option to load a weekly programme using Bluetooth and the Android and iOS app



<sup>1)</sup> Can be used in hot water heating systems with max. operating temperature of 85°C  
For legend, see "Electric operation and Ecodesign Directive" on page 166

## Thermostats

Description		Version	Article number	Price €	Application
<b>Zehnder thermostat "Design Line"</b> Thermostat with integrated fluid sensor. Can be restricted and locked to individual reference value of 6,5 - 28 °C, connection for thermostat M 30 x 1,5		White Chrome Stainless steel optic Copper Bronze <sup>1)</sup> Special finish	841271 841278 853720 853850 853860 841279	<b>64,11</b> <b>64,11</b> <b>131,65</b> <b>171,72</b> <b>171,72</b> <b>73,79</b>	For all radiators with threaded connection M 30 x 1,5 mm
<b>Zehnder thermostat "LH2"</b> Thermostat with integrated fluid sensor, tested according to EN 215. Can be limited and blocked to individual nominal value. Reference range value 7 to 28 °C. Version with zero setting, thermostat threaded connection M 30 x 1,5		White Chrome	819140 819148	<b>35,02</b> <b>60,35</b>	
<b>Zehnder thermostat "DH"</b> Thermostat with integrated expansion material sensor, reference value range 7 to 28 °C. Version with zero setting. Threaded connection M 30 x 1,5 with cover of union nut		White Chrome	819050 819058	<b>35,02</b> <b>53,36</b>	
<b>Zehnder thermostat "SH"</b> Elegant thermostat with integrated fluid sensor, tested according to EN 215, reference value range 7 to 28 °C. Version with zero setting. Thermostat threaded connection M 30 x 1,5 with chrome-plated union nut		White Chrome Stainless steel	819080 819088 819082	<b>38,09</b> <b>53,47</b> <b>53,47</b>	
<b>Angle adapter for thermostat M 30 x 1,5</b>		White	819500	<b>13,92</b>	
<b>Directional air vent, nickel-plated, self-sealing</b>		¼" ½"	816010 816030	<b>4,17</b> <b>4,17</b>	
<b>Decorative directional air vent set, chrome</b> Comprising 2 x directional air vents (½") with cover, vent tool and plug key		Chrome	816508	<b>13,98</b>	
<b>Directional air vent, chrome-plated, self-sealing</b> Suitable for max. operating pressure of 18 bar		½"	816070	<b>7,09</b>	
<b>Blanking plug, nickel-plated, self-sealing</b>		½"	974020	<b>2,39</b>	
<b>Blanking plug, chrome-plated</b> Suitable for max. operating pressure of 18 bar		½"	974058	<b>6,28</b>	

<sup>1)</sup> Suitable for connection fitting and valve body in brass.

## Zehnder Design Line Valves

Description		Version	Article nr.	Price €	Application
<b>Valve set type A</b> Angled flow and lockshield, thermostatic insert M 30 x 1,5 mm with pre-setting 1-7, manual handwheel, including 2 pcs 3/4" Eurocone nuts Ø 16,8 mm in finish of valve body, without adaptors for pipes		White Chrome	838881 838888	<b>76,44</b> <b>76,44</b>	For all radiators with threaded connection M 30 x 1,5 mm
<b>Valve set type B</b> Angled flow and lockshield, manual handwheel thermostatic insert M 30 x 1,5 mm with pre-setting 1-7, including 2 pcs 3/4" Eurocone nuts Ø 16,8 mm in finish of valve body, without adaptors for pipes		White Chrome Stainless steel optic Copper Brass	838891 838898 838930 838900 838910	<b>119,66</b> <b>119,66</b> <b>137,38</b> <b>194,62</b> <b>194,62</b>	
<b>Valve set type C</b> Straight flow and lockshield, manual handwheel thermostatic insert M 30 x 1,5 mm with pre-setting 1-7, including 2 pcs 3/4" Eurocone nuts Ø 16,8 mm in finish of valve body, without adaptors for pipes		White Chrome	838941 838948	<b>119,66</b> <b>119,66</b>	
<b>Valve set type D</b> Reverse flow and angled lockshield, manual handwheel thermostatic insert M 30 x 1,5 mm with pre-setting 1-7, including 2 pcs 3/4" Eurocone nuts Ø 16,8 mm in finish of valve body, without adaptors for pipes		White Chrome	838951 838958	<b>125,37</b> <b>125,37</b>	
<b>Valve set type G</b> Angled-angled flow head to the left, thermostatic insert M 30 x 1,5 mm with pre-setting 1-7, manual handwheel, lockshield angled, including 2 pcs 3/4" Eurocone nuts Ø 16,8 mm in finish of valve body, without adaptors for pipes		White Chrome Stainless steel optic	838981 838988 838980	<b>133,41</b> <b>133,41</b> <b>159,85</b>	
<b>Valve set type I</b> Angled-angled flow head to the right, manual handwheel, thermostatic insert M 30 x 1,5 mm with pre-setting 1-7, lockshield angled, including 2 pcs 3/4" Eurocone nuts Ø 16,8 mm in finish of valve body, without adaptors for pipes		White Chrome Stainless steel optic	838991 838998 838990	<b>133,41</b> <b>133,41</b> <b>159,85</b>	
<b>Valve set type J</b> Single entry/monotube valve vertical, straight, with by-pass, thermostatic insert M 30 x 1,5 mm with pre-setting 1-7, turnable for manual handwheel to the left or right, including 2 pcs 3/4" Eurocone nuts Ø 16,8 mm in finish of valve body and dip tube, without adaptors for pipes		White Chrome	839001 839008	<b>132,50</b> <b>132,50</b>	

➔ Direction of flow

All valves etc. suitable for operating temperature max. 110 °C and operating pressure max. 10 bar, if not indicated differently.  
For further information, please see information in the keyword list.

All valves respectively connection fittings are delivered with handwheels as protection caps (thermostatic heads to be ordered separately) and union nuts as transition to the tube (matching adaptors and connection sets are to be ordered separately!) ➔ see page 162.

## Zehnder Design Line Valves

Description		Version	Article nr.	Price €	Application
<b>Valve type K</b> Single entry/monotube valve vertical, angled, with by-pass, thermostatic insert M 30 x 1,5 mm with pre-setting 1-7, manual handwheel to the right, including 2 pcs 3/4" Eurocone nuts Ø 16,8 mm in finish of valve body and dip tube, without adaptors for pipes		White Chrome Stainless steel optic	839011 839018 839010	<b>129,26</b> <b>129,26</b> <b>197,37</b>	For all radiators with 1/2" female thread
<b>Valve type M</b> Single entry/monotube valve vertical, angled, with by-pass, thermostatic insert M 30 x 1,5 mm with pre-setting 1-7, manual handwheel to the left, including 2 pcs 3/4" Eurocone nuts Ø 16,8 mm in finish of valve body and dip tube, without adaptors for pipes		White Chrome	839021 839028	<b>129,26</b> <b>129,26</b>	
<b>Valve type N</b> Single entry/monotube valve horizontal, straight, with by-pass, thermostatic insert M 30 x 1,5 mm with pre-setting 1-7, manual handwheel to the top, including 2 pcs 3/4" Eurocone nuts Ø 16,8 mm in finish of valve body and dip tube, without adaptors for pipes		White Chrome	839031 839038	<b>173,82</b> <b>173,82</b>	
<b>Valve type O</b> 50 mm straight, thermostatic insert M 30 x 1,5 mm with pre-setting 1-7 and by-pass, turnable for manual handwheel to the left or right, including 2 pcs 3/4" Eurocone nuts Ø 16,8 mm in finish of valve body, without adaptors for pipes		White Chrome	839041 839048	<b>132,50</b> <b>132,50</b>	
<b>Valve type P</b> 50 mm angled, with by-pass, to the right thermostatic insert M 30 x 1,5 mm, with pre-setting 1-7 and by-pass, manual handwheel, including 2 pcs 3/4" Eurocone nuts Ø 16,8 mm in finish of valve body, without adaptors for pipes		White Chrome Stainless Steel optic Copper Brass	839051 839058 839090 839060 839070	<b>132,50</b> <b>132,50</b> <b>171,72</b> <b>228,96</b> <b>228,96</b>	
<b>Valve type Q</b> 50 mm angled, with by-pass, to the left thermostatic insert M 30 x 1,5 mm with pre-setting 1-7 and by-pass, manual handwheel, including 2 pcs 3/4" Eurocone nuts Ø 16,8 mm in finish of valve body, without adaptors for pipes		White Chrome Stainless Steel optic Copper Brass	839101 839108 839140 839110 839120	<b>132,50</b> <b>132,50</b> <b>171,72</b> <b>228,96</b> <b>228,96</b>	
<b>Valve type U</b> 50 mm swiveling design valve straight or angled, with by-pass, thermostatic insert M 30 x 1,5 mm with pre-setting 1-7, manual handwheel to the left or to the right, including 2 pcs 3/4" Eurocone nuts Ø 16,8 mm in finish of valve body, without adaptors for pipes		White Chrome	839171 839178	<b>242,19</b> <b>242,19</b>	
<b>Valve type W</b> Square shaped, angled, lockshield, not thermostatic, manual handwheel, including 2 pcs 3/4" Eurocone nuts Ø 16,8 mm in finish of valve body, without adaptors for pipes		Chrome	839198	<b>220,83</b>	

All valves respectively connection fittings are delivered with handwheels as protection caps (thermostatic heads to be ordered separately) and union nuts as transition to the tube (matching adaptors and connection sets are to be ordered separately!) see page 162.

## Zehnder Design Line Coloured Valves

Description		Version	Article nr.	Price €	Application
<p><b>Zehnder thermostat "Design Line"</b> Thermostat with integrated fluid sensor. Can be restricted and locked to individual reference value of 6,5 - 28 °C, connection for thermostat M 30 x 1,5</p>		Special finish	841279	<b>73,79</b>	For all radiators with 1/2" female thread, in colour of radiator
<p><b>Valve set type B</b> Angled flow and lockshield, thermostatic insert M 30 x 1,5 mm with pre-setting 1-7, including 2 pcs 3/4" Eurocone nuts Ø 16,8 mm in finish of valve body, without adaptors for pipes. Thermostat Design Line with integrated fluid sensor. Can be restricted and locked to individual reference value of 6,5 - 28 °C, connection for thermostat M 30 x 1,5.</p>		Special finish			
		Valve set with manual handwheel	838899	<b>119,66</b>	
		Valve set including Design Line thermostat	839439	<b>193,45</b>	
<p><b>Valve type O</b> 50 mm straight, thermostatic insert M 30 x 1,5 mm with pre-setting 1-7 and by-pass, turnable to the left or right, including 2 pcs 3/4" Eurocone nuts Ø 16,8 mm in finish of valve body, without adaptors for pipes. Thermostat Design Line with integrated fluid sensor. Can be restricted and locked to individual reference value of 6,5 - 28 °C, connection for thermostat M 30 x 1,5.</p>		Special finish			
		Valve set with manual handwheel	839049	<b>132,50</b>	
		Valve set including Design Line thermostat	839409	<b>206,29</b>	
<p><b>Valve type P</b> 50 mm angled, with by-pass, to the right thermostatic insert M 30 x 1,5 mm, with pre-setting 1-7 and by-pass, including 2 pcs 3/4" Eurocone nuts Ø 16,8 mm in finish of valve body, without adaptors for pipes. Thermostat Design Line with integrated fluid sensor. Can be restricted and locked to individual reference value of 6,5 - 28 °C, connection for thermostat M 30 x 1,5.</p>		Special finish			
		Valve set with manual handwheel	839059	<b>132,50</b>	
		Valve set including Design Line thermostat	839419	<b>206,29</b>	
<p><b>Valve type Q</b> 50 mm angled, with by-pass, to the left thermostatic insert M 30 x 1,5 mm with pre-setting 1-7 and by-pass, including 2 pcs 3/4" Eurocone nuts Ø 16,8 mm in finish of valve body, without adaptors for pipes. Thermostat Design Line with integrated fluid sensor. Can be restricted and locked to individual reference value of 6,5 - 28 °C, connection for thermostat M 30 x 1,5.</p>		Special finish			
		Valve set with manual handwheel	839109	<b>132,50</b>	
		Valve set including Design Line thermostat	839429	<b>206,29</b>	

➔ Direction of flow

All valves etc. suitable for operating temperature max. 110 °C and operating pressure max. 10 bar, if not indicated differently. For further information, please see information in the keyword list.

## Zehnder Design Line Valves

Description		Version	Article nr.	Price €	Application
<b>Nut ½", 2 pcs</b> ½" female thread on to ¾" Eurocone		White	842001	<b>24,23</b>	As an adaptor for connection fittings with ½" external thread
		Chrome	842008	<b>24,23</b>	
<b>Adaptors, 2 pcs</b> Multilayer Ø 14 mm		Brass	842160	<b>11,41</b>	Matching to Zehnder Design Line valves and union nuts 2 x ¾" Eurocone (in scope of delivery)
<b>Adaptors, 2 pcs</b> Multilayer 16 x 2,0 mm		Brass	842060	<b>11,41</b>	
<b>Adaptors, 2 pcs</b> PEX 12 x 1,0 mm		Brass	842070	<b>11,41</b>	
<b>Adaptors, 2 pcs</b> Multilayer Ø 16 x 2,25 mm		Brass	842170	<b>11,41</b>	
<b>Adaptors, 2 pcs</b>  Copper Ø 10 mm Copper Ø 12 mm Copper Ø 14 mm Copper Ø 15 mm Copper Ø 16 mm		Brass Brass Brass Brass Brass	842080 842090 842100 842110 842120	<b>7,13</b> <b>7,13</b> <b>7,13</b> <b>7,13</b> <b>7,13</b>	
<b>Nuts Ø 18 mm - ¾" Eurocone + adaptors copper Ø 18 mm</b> 2 pcs		Chrome / brass	842140	<b>35,63</b>	
<b>Nuts Ø 20,8 mm - ¾" Eurocone + adaptors multilayer Ø 20 x 2 mm</b> 2 pcs		Chrome / brass	842150	<b>35,63</b>	
<b>Universal Adaptor set</b> (without nuts ¾" Eurocone - Ø 16,8 mm) - 2 pcs Alu/Pex multilayer 16 x 2,0 mm - 2 pcs PEX 12 x 1 mm - 2 pcs CU 12 mm - 2 pcs CU 14 mm - 2 pcs CU 15 mm		Brass	842180	<b>39,90</b>	
<b>Sleeving kit</b>  L = 70 mm  L = 160 mm		Chrome	853738	<b>24,23</b>	For connecting radiators
		Chrome	853668	<b>31,33</b>	
<b>Sleeving kit 50 mm</b>  for Ø DN 18 L = 70 mm  for Ø DN 18 L = 160 mm  for Ø DN 25 L = 70 mm  for Ø DN 25 L = 160 mm		White	816321	<b>48,40</b>	For connecting radiators
		Chrome	816328	<b>48,40</b>	
		Technoline	816329	<b>72,54</b>	
		White	816331	<b>48,40</b>	
		Chrome	816338	<b>48,40</b>	
		Technoline	816339	<b>72,54</b>	
		White	816341	<b>63,08</b>	
		Chrome	816348	<b>63,08</b>	
		Technoline	816349	<b>87,44</b>	
		White	816351	<b>63,08</b>	
Chrome	816358	<b>63,08</b>			
Technoline	816359	<b>87,44</b>			

## Connection fittings

Description		Version	Article nr.	Price €	Application
<b>Collar Ø 45 mm</b>  - for Ø ½"  - for Ø 10 mm  - for Ø 12 mm  - for Ø 14 mm  - for Ø 15 mm  - for Ø 16 mm  - for Ø 18 mm		White Chrome  White Chrome  White Chrome  White Chrome  White Chrome  White Chrome	816241 816248  816251 816258  816261 816268  816271 816278  816281 816288  816291 816298  816301 816308	<b>2,85</b> <b>7,13</b>  <b>2,85</b> <b>7,13</b>  <b>2,85</b> <b>7,13</b>  <b>2,85</b> <b>7,13</b>  <b>2,85</b> <b>7,13</b>  <b>2,85</b> <b>7,13</b>	For existing connections
<b>Fitting for Zehnder Yucca</b> For single- and twin-tube systems (connection size 50 mm); valve on right, presettable valve insert AV9, flow on both sides, for thermostat M 30 x 1,5; connections at back ¾" external thread, flow/return lockable, with ½" connection for electric heating element on left (can be retrofitted when removing the fittings); connection fitting set to twin-tube operation, can be used for single-tube operation by opening the by-pass screw; supplied as standard with matching cover and cover parts set for the heating element in colour of the radiator (for RAL 9016 without cover parts set), fixings for the cover included with fitting, thermostat available for surcharge; maximum operating pressure 10 bar, 110 °C; version of connection fitting for dual energy operation with WIVAR II / WIVAR Hotel (long cover)		Standard finish Special finish Chrome-plated	976031 976039 976038	<b>172,59</b> <b>233,28</b> <b>289,54</b>	
Version of connection fitting for operation on central heating system (short cover)		Standard finish Special finish Chrome-plated	976021 976029 976028	<b>172,59</b> <b>184,97</b> <b>229,18</b>	
Version of connection fitting without cover		Nickel-plated	976103	<b>130,49</b>	

## Conversion table, f<sub>1</sub> factors

t <sub>1</sub> \ t <sub>2</sub>	t <sub>r</sub>	n	70			65			60			55			50			45				
			1,25	1,30	1,35	1,25	1,30	1,35	1,25	1,30	1,35	1,25	1,30	1,35	1,25	1,30	1,35	1,25	1,30	1,35		
90	10		1,516	1,542	1,568	1,499	1,462	1,483	1,363	1,380	1,397	1,283	1,296	1,309	1,201	1,210	1,219	1,117	1,122	1,127		
	15		1,380	1,398	1,416	1,311	1,319	1,333	1,228	1,238	1,248	1,149	1,155	1,162	1,067	1,070	1,073	0,982	0,981	0,981		
	18		1,300	1,313	1,327	1,229	1,235	1,245	1,148	1,155	1,161	1,069	1,072	1,075	0,987	0,987	0,986	0,902	0,898	0,894		
	20		1,247	1,258	1,269	1,175	1,180	1,187	1,096	1,100	1,104	1,017	1,017	1,018	0,935	0,932	0,930	0,849	0,843	0,838		
	22		1,194	1,202	1,211	1,122	1,125	1,130	1,043	1,045	1,047	0,964	0,963	0,962	0,882	0,878	0,874	0,796	0,789	0,781		
	24		1,142	1,148	1,154	1,069	1,071	1,073	0,992	0,991	0,991	0,913	0,909	0,906	0,830	0,824	0,818	0,743	0,734	0,726		
85	10		1,454	1,476	1,498	1,387	1,398	1,416	1,305	1,319	1,333	1,228	1,238	1,248	1,149	1,155	1,162	1,067	1,070	1,073		
	15		1,319	1,334	1,349	1,251	1,258	1,269	1,172	1,180	1,187	1,096	1,100	1,104	1,017	1,017	1,018	0,935	0,932	0,930		
	18		1,240	1,251	1,261	1,171	1,175	1,182	1,094	1,098	1,102	1,017	1,018	1,019	0,939	0,936	0,934	0,856	0,851	0,846		
	20		1,187	1,196	1,204	1,118	1,121	1,125	1,042	1,044	1,045	0,966	0,964	0,963	0,887	0,883	0,878	0,804	0,797	0,790		
	22		1,135	1,141	1,147	1,065	1,067	1,069	0,991	0,990	0,990	0,915	0,911	0,908	0,836	0,830	0,824	0,753	0,744	0,736		
	24		1,084	1,087	1,091	1,013	1,013	1,014	0,941	0,937	0,935	0,864	0,859	0,854	0,785	0,777	0,770	0,701	0,691	0,682		
80	10		1,391	1,409	1,428	1,325	1,334	1,349	1,247	1,258	1,269	1,172	1,180	1,187	1,096	1,100	1,104	1,017	1,017	1,018		
	15		1,258	1,269	1,281	1,191	1,196	1,204	1,116	1,121	1,125	1,042	1,044	1,045	0,966	0,964	0,963	0,887	0,883	0,878		
	18		1,179	1,187	1,195	1,111	1,114	1,119	1,038	1,040	1,041	0,965	0,964	0,962	0,889	0,885	0,881	0,810	0,803	0,797		
	20		1,127	1,133	1,138	1,059	1,061	1,063	0,987	0,987	0,986	0,914	0,911	0,908	0,839	0,833	0,827	0,759	0,751	0,743		
	22		1,076	1,097	1,082	1,008	1,008	1,008	0,937	0,934	0,932	0,864	0,859	0,854	0,788	0,781	0,773	0,709	0,699	0,690		
	24		1,025	1,026	1,027	0,956	0,955	0,954	0,887	0,883	0,878	0,814	0,808	0,801	0,739	0,730	0,721	0,659	0,648	0,637		
75	10		1,326	1,342	1,357	1,262	1,269	1,281	1,187	1,196	1,204	1,116	1,121	1,125	1,042	1,044	1,045	0,966	0,964	0,963		
	15		1,195	1,204	1,212	1,130	1,130	1,138	1,058	1,061	1,036	0,987	0,987	0,986	0,914	0,911	0,908	0,839	0,833	0,827		
	18		1,118	1,122	1,127	1,051	1,053	1,055	0,982	0,981	0,981	0,912	0,908	0,905	0,839	0,833	0,827	0,763	0,755	0,747		
	20		1,066	1,069	1,072	1,000	1,000	1,000	0,932	0,929	0,927	0,862	0,857	0,852	0,789	0,782	0,775	0,714	0,704	0,695		
	22		1,016	1,016	1,017	0,949	0,948	0,946	0,882	0,878	0,874	0,813	0,806	0,799	0,740	0,732	0,723	0,665	0,654	0,643		
	24		0,966	0,964	0,963	0,899	0,897	0,893	0,833	0,827	0,821	0,764	0,756	0,748	0,692	0,682	0,672	0,616	0,604	0,592		
70	10					1,198	1,204	1,212	1,127	1,133	1,138	1,058	1,061	1,063	0,987	0,987	0,986	0,914	0,911	0,908		
	15					1,068	1,069	1,072	1,000	1,000	1,000	0,932	0,929	0,927	0,862	0,857	0,852	0,789	0,782	0,775		
	18					0,991	0,990	0,990	0,925	0,922	0,919	0,858	0,853	0,847	0,788	0,781	0,773	0,716	0,707	0,697		
	20					0,940	0,939	0,936	0,876	0,871	0,867	0,809	0,802	0,795	0,740	0,731	0,722	0,668	0,657	0,646		
	22					0,890	0,887	0,883	0,827	0,821	0,815	0,761	0,752	0,744	0,692	0,682	0,672	0,620	0,608	0,596		
	24					0,840	0,837	0,831	0,779	0,771	0,763	0,713	0,703	0,694	0,644	0,633	0,622	0,572	0,560	0,547		
65	10								1,066	1,069	1,072	1,000	1,000	1,000	0,932	0,929	0,927	0,862	0,857	0,852		
	15								0,941	0,936	0,936	0,876	0,871	0,867	0,809	0,802	0,795	0,740	0,731	0,722		
	18								0,867	0,862	0,857	0,803	0,796	0,789	0,737	0,728	0,719	0,668	0,657	0,647		
	20								0,818	0,812	0,805	0,755	0,746	0,738	0,689	0,679	0,669	0,621	0,609	0,597		
	22								0,770	0,762	0,755	0,707	0,698	0,688	0,642	0,631	0,620	0,574	0,561	0,549		
	24								0,723	0,714	0,705	0,661	0,650	0,639	0,596	0,584	0,572	0,528	0,515	0,502		
60	10											0,941	0,939	0,936	0,876	0,871	0,867	0,809	0,802	0,795		
	15											0,818	0,812	0,805	0,755	0,746	0,738	0,689	0,679	0,669		
	18											0,747	0,738	0,729	0,684	0,674	0,664	0,619	0,607	0,596		
	20											0,700	0,690	0,680	0,638	0,626	0,615	0,573	0,560	0,548		
	22											0,653	0,642	0,631	0,592	0,579	0,567	0,528	0,514	0,501		
	24											0,607	0,595	0,584	0,546	0,533	0,521	0,483	0,469	0,455		
55	10																0,818	0,812	0,805	0,755	0,746	0,738
	15																0,700	0,690	0,680	0,638	0,626	0,615
	18																0,630	0,619	0,607	0,569	0,556	0,544
	20																0,585	0,572	0,560	0,524	0,511	0,498
	22																0,540	0,527	0,514	0,480	0,466	0,453
	24																0,496	0,482	0,469	0,437	0,422	0,409

**Conversion factors f<sub>1</sub> for converting the standard thermal output at 75/65/20°C to other system temperatures:  $\Phi = \Phi_S \cdot f_1$**

The radiator exponent depends on the model and type of radiator and can therefore be found in the table containing the technical specifications for the respective radiator. For exponents other than those given, the correction factor can be interpolated or precisely calculated according to the above formulae. An exponent of 1,3 can be used for the approximate calculation.

$$\Phi = \Phi_S \times f_1 \quad \text{or} \quad \Phi = \Phi_S \times \left( \frac{\Delta t}{\Delta t_n} \right)^n$$

$$\text{with } \Delta t = \frac{(t_1 - t_r) - (t_2 - t_r)}{\ln \left( \frac{t_1 - t_r}{t_2 - t_r} \right)} = \frac{t_1 - t_2}{\ln \left( \frac{t_1 - t_r}{t_2 - t_r} \right)}$$

**Example for Zehnder Yucca:**

What is the effective output at 60/45/24°C?

Model YSD-130-080;  $\Phi_S = 1024 \text{ W}$ , exponent  $n = 1,30$   
 $t_1 = 60^\circ\text{C}$ ,  $t_2 = 45^\circ\text{C}$ ,  $t_r = 24^\circ\text{C}$

$f_1$  from table:  $f_1 = 0,469$   
 $\Phi_S = \Phi_S \times f_1 = 1024 \text{ W} \times 0,469 = 480 \text{ W}$

## Keyword list

### Accessories

A wide range of accessories are available for various additional uses, such as hanging up towels. For more information, see the section on "Accessories".

### Baffle

To avoid reduced output, e.g. with a riding connection, internal installations, e.g. baffles, deflector plates, guide plates, are required. Detailed information is available on request.

### Benefits

See "Product description"

### CE marking

The CE marking on Zehnder radiators shows that they are manufactured in accordance with the prevailing European standard EN 442 and that the product has been subjected to the prescribed conformity evaluation procedure.



The following parameters, which allow the CE marking to be shown, can be found in the respective product section:

- Model description
- Max. operating pressure
- Nominal heat output

Product/product family	CE - Year
Zehnder Alban	CE - 20
Zehnder Archibald	CE - 16
Zehnder Deseo Verso	CE - 20
Zehnder Arteplano	CE - 17
Zehnder Chime	CE - 20
Zehnder Folio Belt	CE - 16
Zehnder Folio Hybrid	CE - 17
Zehnder Tetris	CE - 23
Zehnder Pera	CE - 20
Zehnder Yucca	CE - 05
Zehnder Vitalo	CE - 13
Zehnder Zenia	CE - 17
Zehnder Metropolitan	CE - 09
Zehnder Kazeane	CE - 17
Zehnder Roda	CE - 08
Zehnder Quaro	CE - 11
Zehnder Subway	CE - 08
Zehnder Toga	CE - 05
Zehnder Forma	CE - 05
Zehnder Stalox	CE - 06
Zehnder Aura	CE - 13
Zehnder Fina Lean Bar	CE - 20
Zehnder Virando	CE - 16
Zehnder Zeta	CE - 14

### Cleaning

With a lambswool cleaning brush or soft cloth. Detailed information is available on request.

### Conversion

Factor for converting the standard thermal output to thermal outputs at other system temperatures; see conversion table of  $f_1$  factors

### Corrosion protection

See "Finish" and "Surface protection"

### Degree of protection

The degree of protection specifies the extent of protection that electrical equipment housing provides against dangerous parts getting into the equipment. The first number indicates the protection against the ingress of foreign objects, and the second the ingress of water.

Example: IP44

1. number = 4 = protection against solid foreign objects, 1,0 mm diameter or larger
2. number = 4 = protection against splash water

### Dimensions

The dimensions indicated in the documentation are correct at the time of printing. Subject to change without notice.

### Electric heating elements

Maximum temperature:

The maximum achievable temperature of the bathroom radiator depends on the following parameters: Nominal thermal output of the radiator, nominal output of the electric heating element, surrounding temperature, time switched on.

Output:

Only a limited electrical output can be installed in the bathroom radiators for safety reasons. Generally, the nominal output of the electric heating element of all Zehnder bathroom radiators should not be greater than the nominal output of the bathroom radiator ( $\Phi_L$  at  $\Delta T$  50 K according to EN 442).

Mounting:

The electric heating element must be sealed with hemp or Teflon tape so that the mains cable is at the back facing the wall.

Please note:

- The electrical installation must comply with local regulations.
- In stationary installation (without plug), a switch must be installed (all-phase isolation from the mains with min. 3 mm contact spacing).
- The bathroom radiator with integrated electric heating element in central heating systems must always be completely filled with water and vented, observing the maximum permissible operating temperature of the applicable electric heating element in hot water heating systems.
- The expansion of the water in the system into the expansion vessel must be guaranteed at all times (do not block return).
- For electric-only bathroom radiators, the defined filling quantity must not be changed.
- The electric heating element must only be opened and the mains cable only replaced by the manufacturer.
- The electric heating element must only be installed vertically (housing always beneath the electric heating element).
- When using radiators with electric heating elements, the qualified electrician is the competent partner for the protective measures to be taken.
- Follow the operating instructions.

Position of electrical connection:

In bathrooms and other wet rooms, special conditions apply to the installation of switches and sockets according to DIN 57100/VDE0100. The suggested position of the socket is chosen so as to facilitate an easy connection. This suggestion does not release the electrical engineer from executing the electrical connection in accordance with local regulations.

Minimum clearances:

The minimum wall and floor clearances must be complied with (see relevant radiator chapter).

The minimum floor clearance must meet the user requirements. The clearance must be increased accordingly in public buildings and to allow the use of cleaning machines.

## Keyword list

### Electric operation and Ecodesign Directive

In deviation from dual energy operation in a central heating system, all electric radiators are fixed units that comprise the actual radiator body, a filling medium (heat transfer fluid), a heating element and associated controls. This unit is subject to a special function test and must not be changed. The heat transfer fluid is frost-proof up to -20°C as long as there are no other restrictions associated with the standard scope of delivery for the radiator in question. The product portfolio also includes dry electric radiators. A large number of radiator models with different control and regulation options are available for a wide range of applications.

Electric radiators are subject to the Ecodesign Directive. The aim of this Directive is to reduce the environmental effects of products that consume energy, with the entire product life-cycle taken into account. A points system is used to evaluate the extent to which the Directive has been fulfilled. Various functions, such as standby power consumption ≤ 0,5 W, weekly programme and open window detection, help to fulfil the minimum legal requirements (that is, they help to achieve the minimum number of points). Devices that meet the minimum requirements and are thus compliant with the Ecodesign Directive are marked with this symbol in the price list: . Towel warmers are not subject to the Ecodesign Directive. They are not intended for room heating and are marked with this symbol: .

The following table provides an overview of the available products combined with different control and regulation devices:

Product/ product family	Control device	Control device in combina- tion with app	Operation on electric heating element	without control device
Zehnder Archibald				
Zehnder Deseo Verso				
Zehnder Folio Glass				
Zehnder Folio Hybrid				
Zehnder Zenia <sup>1)</sup>				
Zehnder Tetris				
Zehnder Yucca				
Zehnder Vitalo				
Zehnder Roda Twist Spa Air				
Zehnder Metropolitan				
Zehnder Kazeane				
Zehnder Quaro				
Zehnder Subway				
Zehnder Toga				
Zehnder Forma				
Zehnder Aura				
Zehnder Fina Lean Bar				
Zehnder Virando				

- Electric radiator (standard)
- Electric radiator (available as an option)
- Towel warmer (standard)
- Towel warmer (available as an option)

### Environment

The certification of our environmental management system to DIN EN ISO 14001 by an independent institution obliges us to make continuous improvements to our environmental services through reducing or avoiding environmental burdens and waste, encouraging the utilisation and protection of resources as well as observing all environmental laws and regulations applicable to us.

### Finish

Ready-painted radiators in this price list have a two-coat finish (to DIN 55900, Part 1 and 2, comprising primer and top coat). The top coat is a powder coating. The high-quality Zehnder powder coating produces an especially smooth and extremely durable surface. Further information on the applications and limits of radiators is contained in information sheet number 7 of the BDH (Bundesverband der Deutschen Heizungsindustrie e.V.). Please always use the original RAL, NCS colour samples or original colour charts of the sanitary manufacturers for exact colour matching.

For technical production reasons, minor colour deviations are possible in paints on steel surfaces, also when taking the prevailing lighting conditions into account. Deviations can also occur when comparing painted steel surfaces (radiators) with ceramic products. The colours shown here (see inside of back cover) are not binding for printing reasons. Radiators in metallic colours, e.g. RAL 9006, RAL 9007 and Anthracite are unique products and visual differences may appear in the colour, depending on the radiator.

### Fixings

To ensure that radiators are fitted safely, the weight of the radiator and other aspects must be considered when choosing the right quality and quantity of brackets. Additional loads and foreseeable misuse of a radiator must be considered or ruled out by planning and implementation in line with the known building use. The installation situation and accessibility are just as important criteria as brickwork, bracket shape, location of the suspensions, locking device, add-on elements and the like. See also VDI 6036.

### Flow connection

This concerns the connection on the radiator through which the hot water flows into the radiator.

### Galvanisation

See "Surface protection"

### Galvanisation

Galvanisation creates structures on the surface. These are caused by the technological process and therefore are not a fault. We cannot guarantee a clean, smooth surface. Galvanised radiators are generally delivered with a top coat. For explanation, see "Surface protection".

## Keyword list

Product/product family	Special version, galvanised
Zehnder Alban	-
Zehnder Archibald	-
Zehnder Arteplano	x
Zehnder Folio Belt	-
Zehnder Folio Hybrid	-
Zehnder Tetris	-
Zehnder Pera	-
Zehnder Yucca	x
Zehnder Vitalo	-
Zehnder Roda Twist Spa Air	-
Zehnder Metropolitan	x
Zehnder Kazeane	x
Zehnder Quaro	x
Zehnder Subway	x
Zehnder Toga	x
Zehnder Forma	x
Zehnder Aura	-
Zehnder Fina Lean Bar	-
Zehnder Virando	-
Zehnder Zeta	-

### Hydraulic balancing

By hydraulic balancing the various system resistances are set so that the radiators are supplied with the necessary quantity of water at all operational points, in order to achieve the desired thermal output.

### Inlet and outlet resistance

The coefficient of resistance (zeta value) is used to calculate the pressure loss. For more information, see "Pressure loss".

### Minimum water flow

If the flow of water through a radiator is heavily reduced, the heat output can fall far below the calculated or indicated value. For this reason, a minimum water flow should always be ensured. The following table shows the approximate minimum water flows  $q_{m \text{ min}}$  in % of the nominal flow rate  $q_{ms}$  which does not cause the heat output to deviate from the standard characteristic curve by more than 5%.

Product/product family	$q_{m \text{ min}}$ in % of $q_{ms}$
Zehnder Archibald	30%
Zehnder Yucca, Zehnder Metropolitan, Zehnder Kazeane, Zehnder Pera, Zehnder Roda Spa Asym, Zehnder Quaro, Zehnder Toga, Zehnder Forma, Zehnder Stalox, Zehnder Aura, Zehnder Zeta	27%
Zehnder Arteplano, Zehnder Fina, Zehnder Folio / Folio Belt, Zehnder Tetris, Zehnder Vitalo	17%
Zehnder Virando, Zehnder Zeta	27%

### Nominal heat output

The nominal heat output of a radiator is determined in an independent, certified test laboratory according to standard EN 442 at the standard operating temperatures of 75/65/20°C. The conversion of the thermal output to other system temperatures is done on the basis of the nominal heat output according to EN 12831. For easy dimensioning, additional outputs for frequently used temperatures are shown alongside the nominal heat output:

- 70/55/24 °C
- 55/45/24 °C
- 55/45/20 °C

The conversion of the nominal heat output to deviating system temperatures can be done using the  $f_1$ -factors on the conversion factors page.

### Operating pressure

The maximum permissible operating pressure of a radiator depends on its geometry, the material used and the finish. Max. permissible operating pressure according to product:

Product/product family	Standard version [bar]	High-pressure version [bar]
Zehnder Alban	5,2	-
Zehnder Archibald	12	-
Zehnder Arteplano	4,6	10
Zehnder Chime	5,2	-
Zehnder Folio Belt	10	-
Zehnder Folio Hybrid	10	10
Zehnder Tetris	4	-
Zehnder Pera	4	-
Zehnder Yucca	12	-
Zehnder Vitalo	10	-
Zehnder Vitalo Easy Fit	6	-
Zehnder Metropolitan	4	-
Zehnder Kazeane	4	-
Zehnder Quaro	10	-
Zehnder Subway	10	18
Zehnder Toga	11,5	18
Zehnder Stalox	12	18
Zehnder Aura	10	-
Zehnder Fina Lean Bar	6	-
Zehnder Virando	10	-
Zehnder Zeta	10	-

Suitable fittings, plugs and air vents, etc. must be ensured in connection with high pressure applications in excess of 10 bar. Pressure loads up to max. 18 bar are only adaptable for suitable radiators and components as long as pressure shocks can be ruled out.

### Operating temperature

Zehnder radiators can generally be used for hot water heating systems up to 110°C. Exceptions are noted on the product in question. They are suitable for use in district heating, low temperature and condensing systems.

### Packaging

The packaging of Zehnder radiators serves as protection against damage during transport and on building sites. It must be removed before starting the system for the first time in order to avoid any damage caused by condensation.

### Pressure loss

Inlet and outlet resistance per radiator for water flow rates of up to 1 m/s  $\zeta = 3,0$ .

The pressure losses of the presettable standard valve sets to be taken into consideration when designing the pump and basic network layout can be taken from the diagrams on the valve characteristics page.

### Prices

See General Sales and Delivery Conditions. You can find these on our homepage at [www.zehnder.ee/muugi-ja-tarnetingimused](http://www.zehnder.ee/muugi-ja-tarnetingimused)

### Product description

At the beginning of each chapter is a description of the radiator together with its product-specific benefits and applications.

## Keyword list

### Protected areas

The provisions of VDE 0100 must be observed when installing radiators with electric heating elements in wet rooms. Examples of the protected area classification for electrical equipment according to VDE 0100 PART 701 for baths and showers. To avoid the risk of corrosion, Zehnder generally recommends to not install steel radiators close to showers, baths or toilets, only when ordered with special surface treatment, see "Surface protection" or in stainless steel.



#### Areas 0 and 1:

Comprise the inside and surrounding areas of bath tubs and shower trays, area 1 ends at the outer edge of the tub/tray. No radiators with electric heating elements must be installed or connected in these areas.

#### Area 2:

Radiators with electric heating elements can be installed and connected here. The electric heating elements and the connection must have at least degree of protection IPX4 (WIVAR II, WIVAR Hotel, RICA, DBM, RACY).

If the connection is made via a plug and socket, the socket must be outside of areas 0, 1 and 2.

### Quality check

Zehnder Group Deutschland GmbH is certified to DIN ISO 9001 and is therefore subject to stringent quality controls carried out by independent institutions in the areas of Design/Development, Production, Assembly and Customer Service.

### Room divider

An overview of how the designer bathroom radiator can be used as a room divider is provided by the following table. Detailed information can be found in the respective product chapters.

Product/product family	Room divider
Zehnder Alban	-
Zehnder Archibald	-
Zehnder Arteplano	-
Zehnder Chime	-
Zehnder Deseo Verso	-
Zehnder Folio Belt	-
Zehnder Folio Glass	-
Zehnder Folio Hybrid	-
Zehnder Tetris	-
Zehnder Pera	-
Zehnder Yucca Asym	X
Zehnder Metropolitan	-
Zehnder Kazeane	-
Zehnder Quaro	X
Zehnder Subway	X
Zehnder Toga	X
Zehnder Forma	-
Zehnder Stalox	-
Zehnder Aura	-
Zehnder Virando	-
Zehnder Zeta	-

### Reduced output

The thermal output can be affected depending on where the radiator is installed. The nominal heat output is measured in an unobstructed setting with a ground clearance of 110 mm and a wall clearance of 50 mm. Any reduction in these clearances, as well as installation in alcoves and the application of covers and grilles can, depending on the model, lead to a reduction in thermal output.

### Standard water flow $q_{ms}$

(heating agent flow, flow quantity, mass flow)

The nominal flow rate  $q_{ms}$  of a radiator gives a temperature spread of 10 K at a flow temperature of 75°C (standard thermal output conditions).

$$q_{ms} = \frac{\Phi}{c_p (t_1 - t_2)} \quad c_p \approx 4187 \frac{\text{J}}{\text{kg} \cdot \text{K}}$$

The actual water flow  $q_m$  of a radiator can, at flow and return temperatures other than 75/65°C, deviate significantly from the nominal flow rate  $q_{ms}$ .

### Example

Zehnder Universal

$\Phi_S = 1093 \text{ W}$  (at 55/45/24: 483 W)

Model HU-180-60

Temperatures: 55/40/24 °C

$$q_{ms} = \frac{483}{4187 (55-40)} \quad q_{ms} = 0.015 \text{ kg/s} \approx 41.5 \text{ kg/h}$$

The actual mass flow  $q_m$  is therefore still:

$$q_m \text{ in } \% = \frac{q_m}{q_{ms}}$$

$$q_m \text{ in } \% = \frac{41,5}{116,5}$$

$$q_m \text{ in } \% = 36\% \text{ from } q_{ms} > 27\%$$

minimum according to table: 27%.

The example therefore satisfies the guideline for the minimum water flow; see also minimum water flow.

### Registration

Zehnder radiators are tested to EN 442 and comply with this standard.

### Returns

Radiators and accessories cannot be returned.

## Keyword list

### Return connection

This concerns the connection on the radiator through which the hot water leaves the radiator and passes along the return line to the heat generator.

### Scope of delivery

The scope of delivery for the standard version of a radiator can be found in the respective product description.

### Seals

In the case of sealed connections and plugs, it may be necessary to tighten up the connection and blanking plugs depending on the water quality, e.g. in a connection to district heating, after testing the pressure or heating the system for the first time. The sealing materials supplied or used by Zehnder are intended for use in closed heating systems.

### Single-pipe systems

Only possible with valves for vertical installation. We recommend using single-tube valves with an adjustable by-pass or a riser, i.e. with an adjustable water volume above the radiator. Only single-tube valves with baffle plates of at least 120 mm in length may be used. TKM and Oederlin systems with screw-in turbulators and 150 mm baffle plate. Essentially, a reduced output of at least 25% must be considered when using single-tube baffle plates. Function is often guaranteed only for certain models and up to specific lengths. Maximum lengths and an indication of how the radiators function with various makes of valve is available on request.

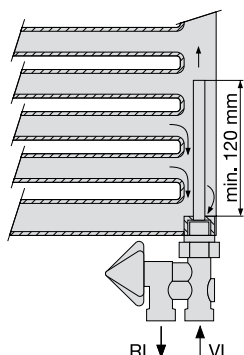

### Special finish

Zehnder radiators are available in almost every colour conceivable. The Zehnder colour chart shows a selection of the possible colours from various colour systems, such as RAL colours, sanitary colours or the NCS-S system.

The standard finish for the entire Zehnder radiator programme is the colour RAL 9016, Traffic White. A further 33 popular colours form Zehnder colour category 1 (see the respective product tables for prices); another 12 form Zehnder colour category 2, with a surcharge on colour category 1. All other paintable colours are available for a surcharge on request.

Another coating option is the clear lacquer version for Zehnder Metropolitan (Technoline), which falls in category 2. This essentially concerns one unique colour for each radiator. For this reason, different surface structures and visual colour differences can also occur at a later point in time.

These colour deviations are not a fault and are therefore not subject to claims under warranty as described in our General Sales and Delivery Conditions.

Special prices apply for highly-polished metal surfaces and metal look. Refer also to the paint and colour chart on the back cover.

### Standard data set

The standard data set contains all technical information required by layout programmes. Free data sets can be requested direct from Zehnder or downloaded from the internet ([www.zehnder.ee](http://www.zehnder.ee); [www.zehnder.lv](http://www.zehnder.lv); [www.zehnder.it](http://www.zehnder.it)).

### Standard colour and coating

The standard colour for Zehnder radiators is RAL 9016. For more information, see "Finish".

### Storage

Zehnder radiators must be stored for the long term or temporarily in dry and chemical-free rooms.

### Surface protection

We recommend that installation areas affected by damp or chemicals are only fitted with radiators that are galvanised and then given a powder coating.

For possible applications, see "Galvanisation".

### System temperatures

These are the temperatures at which the hot water heating system is operated (flow, return and room temperature).

### Test pressure

Each radiator is checked for leaks by subjecting it to 1,3 times its rated maximum operating pressure before delivery. For orders that do not indicate the actual operating pressure, the radiator will be delivered with the operating pressure of the standard version.

### Technical specifications

The technical specifications indicated in the documentation are correct at the time of printing. We reserve the right to make amendments that improve the product.

### Technoline

See "Special finish"

### Tolerances

Industry-standard tolerances and tolerances based on production technology are subject to change for all indicated dimensions and fall within the tolerances defined in EN 442. The maximum tolerance must be considered during pre-assembly of the pipework or fixing materials. We reserve the right to make technical amendments during the validity of the documentation as part of product improvement.

### Tender specification

The description of a product is shown in the respective chapter in the product description section.

### Thermal output $\Phi$

The thermal output of a radiator model is given by the standard characteristic curve:

$$\Phi = K_M \cdot \Delta T_n$$



EN 442 defines the pan-European test procedure and the measurement method in identically arranged test laboratories.

According to the EN 442 standard, the higher temperature is calculated from the logarithmic mean between flow and return temperature as well as the intake air temperature.

Excess temperature  $\Delta T$ :

$$\Delta T = \frac{t_1 - t_2}{\ln \left( \frac{t_1 - t_r}{t_2 - t_r} \right)}$$

The thermal output for excess temperatures  $\Delta T$  other than the standard excess temperature  $\Delta T = 50 \text{ K}$  can be calculated via the

$$\Phi = \Phi_S \times \left( \frac{\Delta T}{50 \text{ K}} \right)^n$$

equation.

## Keyword list

Example for calculating the thermal output  $\Phi$ :

$$\begin{aligned}\Phi_S &= 1024 \text{ W} \\ n &= 1,30 = \text{exponent} \\ t_1 &= 60^\circ\text{C} \\ t_2 &= 40^\circ\text{C} \\ t_r &= 24^\circ\text{C}\end{aligned}$$

$$\Delta T = \frac{60 - 40}{\ln\left(\frac{60-24}{40-24}\right)} = 24,7 \text{ K}$$

$$\Phi = 1024 \text{ W} \times \left(\frac{24,7 \text{ K}}{50 \text{ K}}\right)^{1,30} = 1024 \text{ W} \times 0,40 = 409 \text{ W}$$

also see “Nominal heat output”

### VDI 6036

Application of the directive VDI 6036 assists all participants in the process to make a comprehensive and comparable assessment of the installation situation. As an accepted rule of technology, this directive and the resulting assessment can also be drawn on for regulation purposes in the event of damages. Directive VDI 6036 classifies applications for radiator fastenings into various requirements classes with different loads. Additional loads for various intensities of misuse can be added to the net weight and water content of the radiator as required. Zehnder publishes a recommendation for the allocation of selected fixing elements – provided not labelled otherwise – by standard for the requirements classes 1 and 2 and stable wall structures (e.g. concrete). Assignment recommendations for requirements class 3 and for special custom applications (requirements class 4) on request.

Example applications from VDI 6036:

**Requirements class 1 and 2** (normal and increased requirements): owner-occupied homes, rented flats, kindergartens, hospitals, retirement and nursing homes, office buildings, doctors’ surgeries/ lawyers offices, retail outlets.

**Requirements class 3** (high-level requirements): schools, sports facilities, youth centres, meeting places, railway stations, barracks

**Requirements class 4** (very high-level requirements or special burdens): prisons, psychiatric institutions, special agreements

### Wall clearance

This is the distance between the wall and the back of the radiator. For more information, see “Reduced output”.

### Warranty

See our warranty conditions in our General Sales and Delivery Conditions ([www.zehnder.ee/muugi-ja-tarnetingimused](http://www.zehnder.ee/muugi-ja-tarnetingimused)), the warranty period for the products shown in the Price List is 5 years, and for electrical components just 2 years.

### Water quality

Operating conditions and water quality according to VDI 2035 must be maintained.

Claims under guarantee will be rejected if substances (e.g. chemicals, antifreeze, etc.) which have an aggressive effect on the sealing material are added to the heating water. In case of non-compliance, no liability can be accepted in accordance with point 8 of our General Sales and Delivery Conditions for sealing material, nor for any resulting defects and consequences. Claims under guarantee in accordance with point 8 of our General Sales and Delivery Conditions will also be rendered invalid in case of:

- Operation with steam,
- Periodical or long-term emptying of the system,
- Excessive sludge in the radiators and
- Occasional or constant see page of oxygen into the system.

### Wet rooms

See “Surface protection”

### WEEE Statement

This product may not be treated as household waste. Instead it should be handed to an appropriate collection point for the recycling of electrical and electronic equipment. For more detailed information about the recycling of this product, please contact your local council office or your household waste disposal service.



Legend		
Icon	Unit	Description
H	mm	Height
L	mm	Length
T	mm	Depth
H Lam.	mm	Height of fins
N	mm	Boss spacing
A	m <sup>2</sup>	Surface
V	dm <sup>3</sup>	Water content
M	kg	Empty weight
t <sub>1</sub>	°C	Flow temperature
t <sub>2</sub>	°C	Return temperature
t <sub>r</sub>	°C	Room air temperature
t <sub>m</sub>	°C	Mean water temperature (t <sub>1</sub> +t <sub>2</sub> )/2
ΔTn	K	Standard excess temperature t <sub>m</sub> - t <sub>r</sub>
ΔT	K	Excess temperature t <sub>m</sub> - t <sub>r</sub>
Φ	W=(J/s)	Thermal output
Φ <sub>S</sub>	W	Nominal heat output
Φ <sub>L</sub>	W	Nominal heat output of the module
C <sub>p</sub>	J/(kg K)	Specific heat capacity
n	-	Radiator indicator, exponent
S <sub>k</sub>	%	Proportion of radiation
C <sub>k</sub>	-	Conversion factor to Φ <sub>S</sub>
q <sub>m</sub>	kg/h/(kg/s)	Water flow
q <sub>ms</sub>	kg/h/(kg/s)	Nominal flow rate
v	m/s	Velocity
Δp	kPa	Pressure loss, pressure drop
ζ	-	Coefficient of resistance
ln	-	Natural logarithm

Physical unit	
°C	Degrees, Celsius
K	Kelvin, unit for temperature difference
m	Metres
mm	Millimetres
m/s	Metres/second, flow rate
Pa	Pascal, 1 Pa = 0,102 mmWS
mmWS	mm water column
W	Watt, unit of power 1 W = 0,6 kilocalories/hour old unit of power, 1 kcal/h = 1,163 W
c	Specific heat capacity of water = 1 kcal/kg K = 4,187 kJ/kg K
kJ	Kilojoule, 1 kJ = 0,239 kcal

# Constant fresh air: hygienic, comfortable, healthy.

Easier, more efficient and more comfortable: ventilation systems from Zehnder achieve the legally required minimum air exchange, deliver lower heating costs and provide for a comfortable indoor climate all year round. Over 40 years' experience developing and producing form the basis for Zehnder complete systems. The individual components, intelligently designed to work together, are characterised by the highest level of functionality and durability.



- Outdoor air
- Supply air
- Extract air
- Exhaust air

- 1 Supply of fresh air:** Fresh and filtered air is fed into the system via an external wall vent. The fresh outdoor air can optionally flow through a sub-soil heat exchanger beforehand which uses geothermal energy to pre-temper the outdoor air.
- 2 Ventilation unit:** Up to 95% of the heat is recovered from the extract air and transferred to the fresh air. This can be humidified, dehumidified, heated and cooled using optional components.
- 3 Air distribution:** The air distribution system channels fresh air at the right temperature to individual rooms as needed and vents the extract air to the outside. The air volume can be individually adjusted for each room



### Ventilation unit Efficient and intelligent

The core of the ventilation system enables a high level of heat recovery, low energy consumption and very quiet operation. The control unit offers direct access to the most important functions. The menu-guided operation is simple and intuitive; a display provides information about the current status of the ventilation system. Zehnder ventilation units can also be integrated in a Building Management System (BMS).

System expansions, such as a sub-soil heat exchanger or an air tempering unit, can be added to the ventilation system as an option. A sub-soil heat exchanger enables additional pre-tempering of the supply air during both summer and winter – for even more comfort and even greater energy savings. With an air tempering unit, the supply air is actively tempered and dehumidified by means of a heat pump.

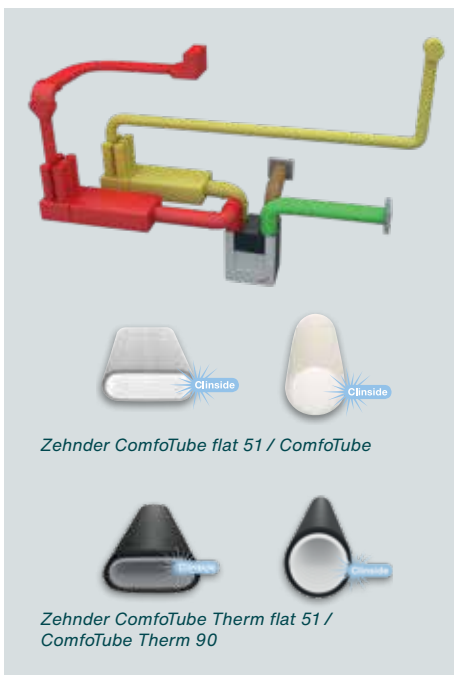

### Air distribution system Hygienic and clean

In addition to the ventilation unit, the air distribution system also plays an essential role in the optimum functionality of comfortable indoor ventilation: it influences ventilation performance, appearance, energy efficiency, hygiene and ease of maintenance. The unique variety of the Zehnder product portfolio offers solutions for every situation. The air distribution system is installed invisibly in the wall, ceiling or floor. Clinside, the smooth inner skin of the ventilation tubes, prevents the build-up of dust. Only minimal maintenance is necessary for optimal operation and the filter is replaced swiftly and smoothly. With the new pre-insulated air distribution system Zehnder ComfoFresh with Thermal Shield, Zehnder is taking the next step towards for improving indoor climate solutions: In addition to the transport of clean, fresh air, the new pre-insulated components also enable good-quality air into the living space at a pleasant temperature.



### Designer grilles, valves and slot diffusers Perfect appearance

Design cover grilles, valves or slot diffusers in white, black or stainless steel look, whether in white, black or stainless steel look, discreetly conceal the outlets the outlets for supply and extract air in the living room. They provide a pleasant, and noiseless supply of fresh air without draughts.

# Warm colours

## Colour category 1: CORE

<b>White Quartz</b> 0521	<b>Pure White</b> RAL 9010	<b>Edelweiss</b> 0067	<b>Cream</b> RAL 9001	<b>Telegrey 4</b> 7247 Ref. tone.: RAL 7047
<b>Beige Quartz</b> 0523	<b>Golden Sand</b> 0258	<b>Yellow Grey</b> 7234 Ref. tone.: RAL 7034	<b>Pearl Beige</b> 1235 Ref. tone.: RAL 1035	<b>Beach Gold</b> 0272
<b>Concrete Grey</b> 0265	<b>Beige Grey</b> 0267	<b>Bronze</b> 0276	<b>Brown Quartz</b> 0529	<b>Dark Brown</b> 0270
<b>Grey Aluminium</b> 9007	<b>Anthracite</b> 0346	<b>Umbra Grey</b> 7222 Ref. tone.: RAL 7022	<b>Volcanic</b> 0336	

## Colour category 2: TREND

<b>Pastel Green</b> 6219 Ref. tone.: RAL 6019	<b>Reseda Green</b> 6211 Ref. tone.: RAL 6011	<b>Cement Grey</b> 7233 Ref. tone.: RAL 7033	<b>Olive Green</b> 6203 Ref. tone.: RAL 6003
<b>Terracotta Faded</b> 0299	<b>Terracotta</b> 0292	<b>Ruby Red</b> RAL 3003	

Surcharge for colour category 2: 146,76 €

Unlike to the colour standard (here RAL tone) the Zehnder no. also includes the features matt respectively glossy. Therefore the RAL standard and Zehnder no. differ in many colours. Please note that the prices always relate to the given finishes matt or glossy, deviating finishes will be calculated like colours outside of the colour cart. These colours are finished with a gloss finish; all other colours are matt-finished.

Other special finishes in the RAL, RAL-D, NCS-S, Sanitary, DB colour systems are available as required, surcharges on request.

# Cool colours

## Colour category 1: CORE

<b>White Matt</b> 0556	<b>Light Beige</b> 0253	<b>Light Grey</b> 0262	<b>White Aluminium</b> 9006	<b>Light Jeans</b> 0264
<b>Titane</b> 0335	<b>Inox Look</b> 0332	<b>Telegrey 2</b> 7246 Ref. tone.: RAL 7046	<b>Blue Grey</b> 7231 Ref. tone.: RAL 7031	<b>Anthracite Grey</b> RAL 7016
<b>Black Quartz</b> 0550	<b>Black Matt</b> 0557	<b>Traffic Black</b> 9217 Ref. tone.: RAL 9017	<b>Jet Black</b> RAL 9005	

## Colour category 2: TREND

<b>Pastel Blue</b> 5224 Ref. tone.: RAL 5024	<b>Pigeon Blue</b> 5214 Ref. tone.: RAL 5014	<b>Gentian Blue</b> 5210 Ref. tone.: RAL 5010	<b>Sapphire Blue</b> 5203 Ref. tone.: RAL 5003	<b>Blue Night</b> 0289

Surcharge for colour category 2: 146,76 €

## FINISHES

<b>Technoline (Clear)</b> 0325	<b>Chrome (Surface)</b> 0008	<b>Stainless steel brushed</b> 9517

## STANDARD

<b>Traffic White</b> RAL 9016

## EXPLANATION

<b>Colour name</b> Zehnder-Nr. Colour norm

These colours are finished with a gloss finish; all other colours are matt-finished.

Some colours and finishes are only available for selected products. RAL-codes are descriptions of manufacturer. Special colour shades on request. Despite extreme care in the production of this color chart as well as in the painting process of our radiators, slight colour deviations, depending on the production series and compared to other colour carriers (ceramic, paper, metal ...) possible.

**Zehnder Baltics OÜ**

Rannamõisa tee 38d ■ 13516 Tallinn ■ Estonia

+372 6840 937 ■ [info.baltics@zehndergroup.com](mailto:info.baltics@zehndergroup.com) ■ [www.zehnder.ee](http://www.zehnder.ee) ■ [www.zehnder.lv](http://www.zehnder.lv) ■ [www.zehnder.it](http://www.zehnder.it)